

CS INSTRUMENTS

PROVEN AND INNOVATIVE MEASURING TECHNOLOGY FOR COMPRESSED AIR AND GASES



Chart recorder



Dew Point



Flow



Compressed air quality



Leakage



Software



Current



Pressure



Ambient air





OVERVIEW CHART RECORDER

DS 500



- Chart recorder for data logging of up to 4/8/12 sensors
- 7" colour screen with touch panel
- Ethernet connection
- 16 GB data memory

Page 12-15

DS 400



- Chart recorder for data logging of up to 2/4 sensors
- 3.5" colour screen with touch panel
- **Option:** Ethernet connection
- **Option:** 16 GB data memory

Page 16-19

DS 500 mobile



- Chart recorder for data logging of up to 4/8/12 sensors
- 7" colour screen with touch panel
- In a sturdy service case for field use
- Ethernet connection
- 16 GB data memory

Page 24-27

DS 500 PM mobile



- For efficiency measurement of compressors
- Chart recorder with integrated current/effective power meter
- 3 hinged current transformers encompass the connectors of the phases L1, L2, L3
- Magnetic measuring tips for tapping the voltage
- 3 / 7 / 11 additional sensor inputs available

Page 28-31

DS 400 mobile



- Chart recorder for data logging of up to 2/4 sensors
- 3.5" colour screen with touch panel
- In a sturdy service case for field use
- Integrated Li-Ion battery
- Ethernet connection
- 16 GB data memory

Page 32-35

PI 500



- Portable handheld device
- 1 sensor input
- 3.5" colour screen with touch panel
- Integrated Li-Ion battery
- 16 GB data memory

Page 36-37

Sensors for DS 500 / DS 400

Pressure



Current



Temperature



Page 20-23

Sensors for mobile devices

Pressure



Current

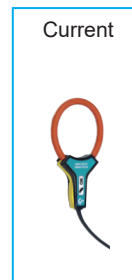

Temperature



Page 38-41



DP 500/510



- Mobile dew point device
- Meas. range -80...+50 °Ctd pressure dew point
- 3.5" colour screen with touch panel
- Integrated Li-Ion battery
- 16 GB data memory

Page 46-47

DP 400 mobile



- Mobile dew point device in a sturdy service case
- Integrated pressure measurement up to 16 bar
- Meas. range -80...+50 °Ctd pressure dew point, ppm, atmospheric dew point, etc...
- Integrated Li-Ion battery

Page 48-49

FA 510/515



- Dew point sensor for residual moisture measurement in compressed air and gases
- Measuring range: -80...+20 °Ctd or -20...+50 °Ctd
- 4...20 mA analogue output and/or Modbus-RTU

Page 50

DS 52



- Plug-in dew point set
- Measuring range: -80...+20 °Ctd or -20...+50 °Ctd
- 2 alarm relays (freely adjustable)
- 4...20 mA analogue output

Page 51



FA 515 EX



- Dew point sensor for residual moisture measurement in compressed air and gases in potentially explosive atmospheres
- Meas. range -80...+20 °Ctd
- Approvals: Zone 1: Gas Zone 21: Dust
- 4...20 mA analogue output

Page 52

FA 550



- Dew point sensor with a sturdy die-cast aluminium housing
- IP 67, suitable for outdoor use
- 2x 4...20 mA analogue output and Modbus-RTU
- Option: Ethernet interface

Page 54-55

FA 500



- Dew point sensor with integrated display
- Measuring range: -80...+20 °Ctd or -20...+50 °Ctd
- 4...20 mA analogue output and Modbus-RTU
- Option: Ethernet interface

Page 56-57

DS 400



- Plug-in dew point set
- Option: integrated data logger dew point monitoring
- Option: Ethernet interface
- 3.5" colour screen with touch panel

Page 58-59



VA 570



- Inline flow meter with flange
- Sturdy die-cast aluminium housing IP 67
- Option with ATEX or DVGW approval
- All wetted parts of stainless steel
- DN 15 to DN 80

Page 72-76

VA 570



- Inline flow meter with thread
- Sturdy die-cast aluminium housing IP 67
- Option with ATEX or DVGW approval
- All wetted parts of stainless steel
- 1/2" to 2"

Page 72-76

VA 550



- Sturdy flow meter as an insertion version
- Easy installation and removal under pressure without line interruption
- Applicable in existing pipes from 3/4" to DN 1000
- Option with ATEX or DVGW approval
- All wetted parts of stainless steel

Page 78-81

VA 500



- Flow meter as an insertion version
- Easy installation and removal under pressure without line interruption
- Applicable in existing pipes from 1/2" to DN 1000
- Option: Bi-directional measurement

Page 82-84

VA 520



- Inline flow meter with flange
- DN 15 to DN 80
- Option: Bi-directional measurement

Page 86-90

VA 520



- Inline flow meter with thread
- 1/4" to 2"

Page 86-90

VA 521



- Compact Inline flow meter
- No inlet section necessary – integrated flow straightener
- Sensor unit removable
- 1/4" to 2"

Page 92-93

VA 525



- Compact Inline flow meter for air and nitrogen
- No inlet section necessary – integrated flow straightener
- 1/4" to 2"

Page 94-95



VD 500



- **Flow sensor for wet compressed air**
- Measuring directly after the compressor
- Measurement at high temperatures
- Measurement of fast processes

Page 96-97

VU 570



- Vortex ultrasonic flow sensor
- Independent of the gas composition
- Integrated pressure and temperature compensation
- Technical gases
- Mixed gases
- Compressed air in PET bottles production

Page 98-100

VX 570



- Vortex flow sensor
- Measurement of saturated steam or superheated steam
- Measurement of liquids
- Measurement of mixed gases
- Measurement of corrosive media

Page 102-103

Accessories for Consumption Measurement / Calibration / Measuring ranges for different gases

Page 106-121



Oil-Check 400 / PC 400 / FA 510



- Measure compressed air quality according to ISO 8573
- Residual oil - particles - residual moisture
- Stationary solution

Page 126-127

Oil-Check 400 / PC 400 / FA 510



- Measure compressed air quality according to ISO 8573
- Residual oil - particles - residual moisture
- Mobile solution

Page 127

Oil-Check 400 - stationary solution



- Monitoring system for residual oil content measurement in compressed air

Page 128-129

Oil-Check 400 - stationary solution



- Monitoring system for residual oil content measurement in compressed air
- With handle and stand plus flight case as an option

Page 129

PC 400 / DS 400 - stationary solution



- Monitoring system for particle measurement in compressed air

Page 130-131

PC 400 / DS 500 mobile solution



- Monitoring system for particle measurement in compressed air
- PC 400 in a service case
- DS 500 mobile in a sturdy service case

Page 131



UltraCam LD 500 / 510



- Leak detector with camera
- Enormous time saving compared to classic leak detectors
- 30 MEMS microphones create the image of the leaks
- Brightness sensor activates LEDs in dark surroundings

Page 132-140

LD 500 / 510



- Leak detector with camera
- Shows leakage rate in l/min and costs in euros
- Unique laser distance measurement for automatic cost determination
- USB interface for data transfer into the evaluation software CS Leak Reporter

Page 134-140

LD 450



- Low-price leak detector

Page 142-143

CS Leak Reporter

- Creates detailed ISO 50001 reports
- Provides an illustrated overview of the leakages found and their savings potential
- License for 2 workstations

CS Leak Reporter - Cloud solution

- Browser-based access to the CS Cloud
- Common database for all users in real time
- Paperless documentation
- Any number of guest accesses (reading rights) can be set up

Page 137

Leakage Report	Start: 15/04/2019	End: 25/04/2019	Duration: 10 day(s)
Contact details:			
Company:	Customer: Acme	Auditor: John Sample	
Address:	...	1 Sample St., 12345 Sampletown	
E-mail:	johnacme@sample.com	j.sample@acme.com	
Phone:	...	+49 1234 567800	
Logo:			
Project master data:			
Import date:		CO ₂ emissions:	0.527 kg/kWh
Cost calculation basis:	Energy costs (70%)	Specific output:	0.12 kWh/m ³
Compressed air costs:	21.6 €/1000 m ³	Electricity price:	0.18 €/kWh
Operating hours per year:	4350 h		
Results:			
Number of leaks:	141	Improvements:	
Total leakage amount:	716.126 ltr/min	Number remedied:	1
Total costs per year:	4,048.40 €	Leakage amount saved:	3.468 ltr/min
Total CO ₂ per year:	11.91 tonnes	Costs saved per year:	19.55 €
		CO ₂ saved per year:	0.06 tonnes
Leak tag: 1			
	Building - location:	COMPRESSOR ROOM 1	Repair under pressure possible? - No
	Date and time:	15/04/2019 12:08:03	Error: Ball valve defective
	Leakage rate:	< 1.395 ltr/min	Spare part: 1/2" ball valve
	Costs per year:	< 7.86 €	Action: Replace
	Total CO ₂ per year:	0.02 tonnes	Note: -
	Priority:	Low	Status: Open
	Comment:	Replace ball valve	Remedied on: -
			Remedied by: -
Leak tag: 2			
	Building - location:		Repair under pressure possible? - No
	Date and time:	15/04/2019 12:08:19	Error: Flange leaking
	Leakage rate:	2.519 ltr/min	Spare part: DN 100 flange seal
	Costs per year:	14.2 €	Action: Reestablish seal
	Total CO ₂ per year:	0.04 tonnes	Note: -
	Priority:	High	Status: Done
	Comment:	Reestablish flange seal	Remedied on: 16/04/2019
			Remedied by: AM



OVERVIEW SOFTWARE

CS Basic



- Data evaluation as a graph or in table form
- Reading the measurement data of all CS Instruments data loggers / chart recorders via USB or Ethernet

Page 144-145

CS Network



- Energy monitoring software with Client/Server solution
- Automatically collects the measured values of all CS devices in the network on servers
- Evaluation / analysis at any number of workplaces (Client)

Page 146-148



OVERVIEW PRESSURE



Differential pressure probe

- For testing on Compressed air systems
- For use before and after the filter elements.

Page 150-151



PTS 500

- 2 in 1 sensor: measures pressure and temperature in the process
- Modbus-RTU, Ethernet or M-Bus interface

Page 152



DPS 16

- Digital temperature compensation and non-linearity correction
- RS 485 interface (Modbus-RTU)



CS 16

- Welded measuring system with no seals

Page 153



OVERVIEW AMBIENT AIR



IAC 500

- 3 in 1 sensor: Absolute pressure, temperature and humidity in the room
- Monitoring the intake air of compressed air stations
- Monitoring of room air e.g. cold rooms, storage rooms or clean rooms

Page 154

OVERVIEW CONVERSION UNITS

Conversion table

PSI	Bar
1	0.07
2	0.14
3	0.21
4	0.28
5	0.34
6	0.41
7	0.48
8	0.55
9	0.62
10	0.69
11	0.76
12	0.83
13	0.90
14	0.97
15	1.03
20	1.38
25	1.72
30	2.07
40	2.76
50	3.45
60	4.14
70	4.83
80	5.52
90	6.21
100	6.89
110	7.58
120	8.27
130	8.96
140	9.65
150	10.34
200	13.79
250	17.24
300	20.68
400	27.58
500	34.47
600	41.37
700	48.26
800	55.16
900	62.05
1000	68.95
1500	103.42
3000	206.84
5000	344.74

F°	C°
-148	-100
-112	-80
-94	-70
-76	-60
-58	-50
-40	-40
-22	-30
-4	-20
14	-10
32	0
50	10
68	20
86	30
104	40
122	50
140	60
158	70
176	80
194	90
212	100
230	110
248	120
266	130
284	140
302	150
392	200
482	250
572	300
662	350
752	400
842	450
932	500

mm	Inch
1	0.04
2	0.08
3	0.12
4	0.16
5	0.20
6	0.24
7	0.28
8	0.31
9	0.35
10	0.39
11	0.43
12	0.47
13	0.51
14	0.55
15	0.59
16	0.63
17	0.67
18	0.71
19	0.75
20	0.79
25	0.98
30	1.18
35	1.38
40	1.57
45	1.77
50	1.97
55	2.17
60	2.36
65	2.56
70	2.76
75	2.95
80	3.15
85	3.35
90	3.54
95	3.74
100	3.94
105	4.13
110	4.33
115	4.53
120	4.72
125	4.92
130	5.12
135	5.31

Inch	mm
1/8	3
1/6	4
1/5	5
1/4	6
1/3	8
2/5	10
1/2	12
3/5	15
2/3	17
3/4	19
4/5	20
1	25
1 1/6	30
1 3/8	35
1 4/7	40
1 7/9	45
2	50
2 1/6	55
2 1/3	60
2 5/9	65
2 3/4	70
3	75
3 1/7	80
3 1/3	85
3 1/2	90
3 3/4	95
4	100
4 1/7	105
4 1/3	110
4 1/2	115
4 5/7	120
5	125
5 1/8	130
5 1/3	135

1

Efficiency measurement + compressed air audits

- Electrical power measurement (page 23)
- Compressor capacity (page 96)
- Data logger / chart recorder (page 12-45)
- CS Basic Software (page 144-145)
- Compressor intake conditions (page 154)
- System pressure (page 152)

2

Compressed air quality ISO 8573-1

- Dew point (page 50-59)
- Residual oil (page 126-131)
- Particles (page 126-131)

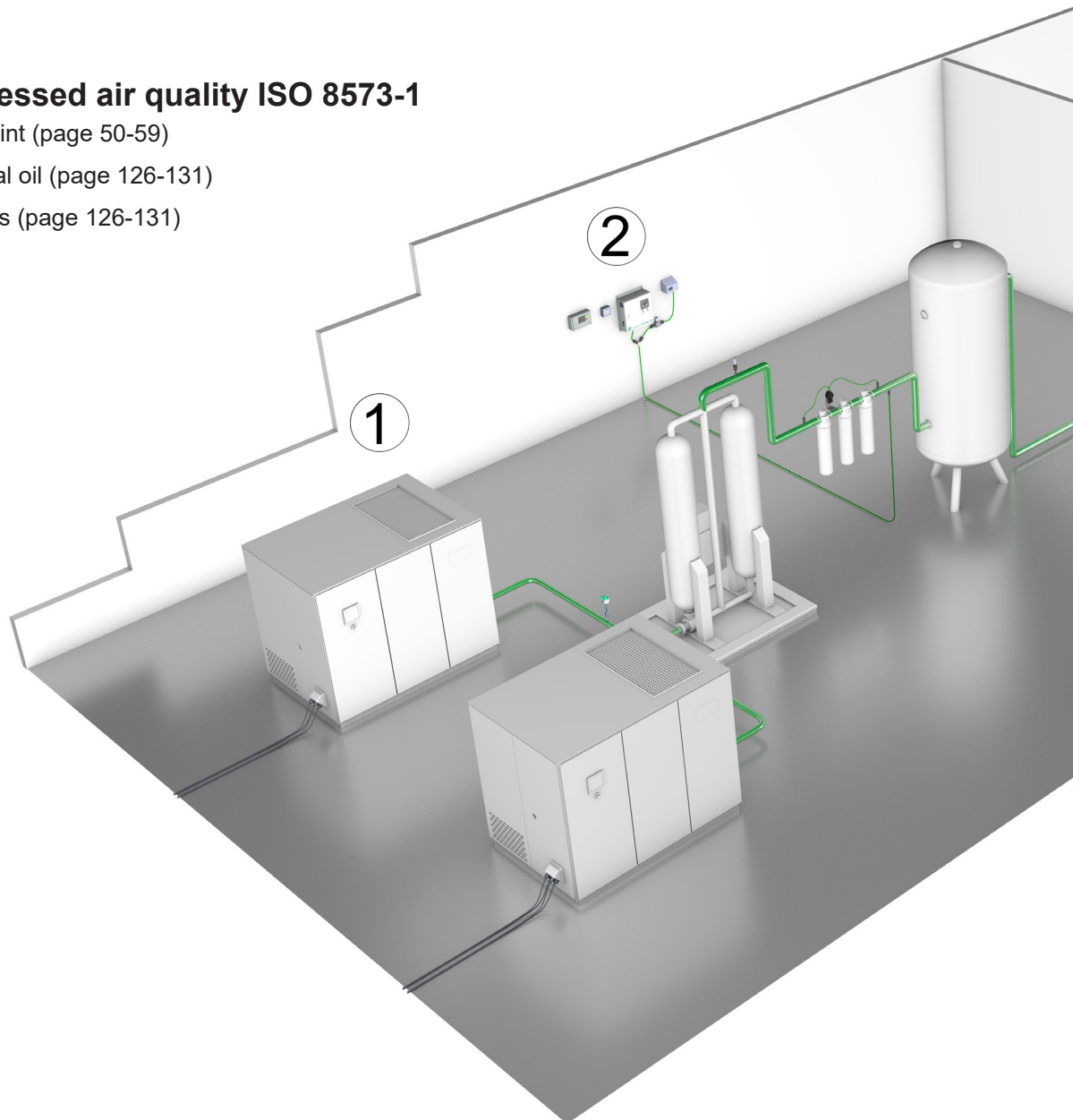

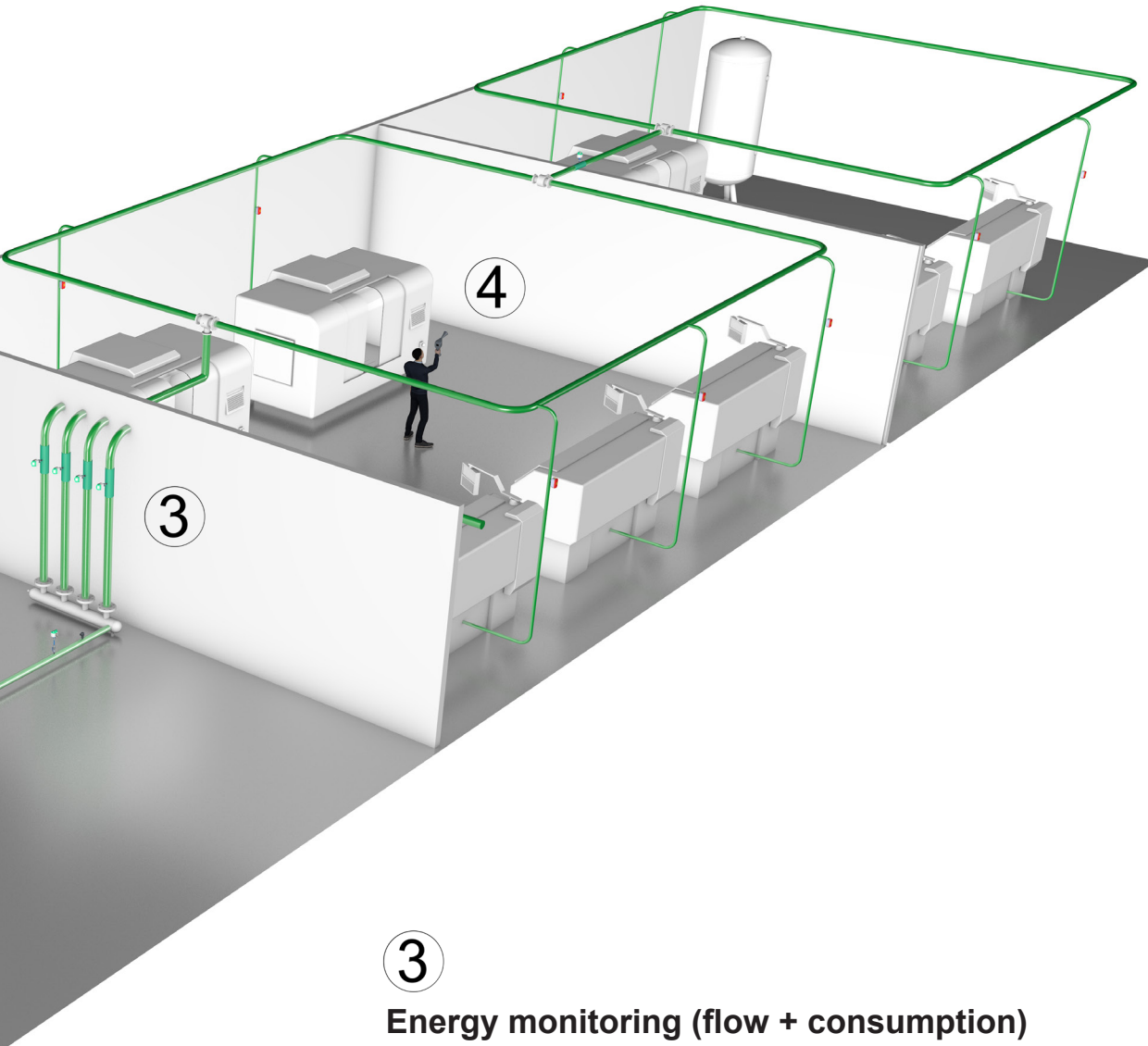

3

Energy monitoring (flow + consumption)

- Insertion version (page 82-84)
- Inline version (page 86-90)
- Compact version (page 92-95)
- CS Network Software (page 146-148)

4

Leak detection

- Leak detector with camera - shows leakage rate in l/min and costs in € (page 132-140)
- CS Leak Reporter Software - creates detailed ISO 50001 reports (page 137)



DS 500 - Intelligent chart recorder for compressed air and gases

Measurement - control - indication - alarm - recording - evaluation

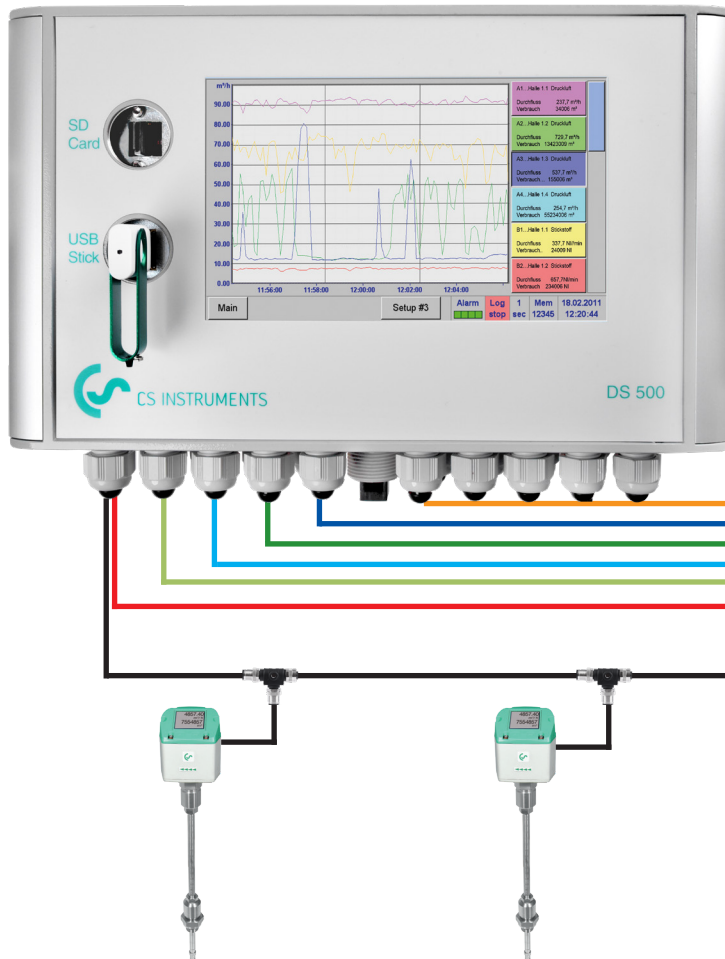

Advantages at a glance:

- **Clear layout:** 7" colour screen with touch panel...
- **Versatile:** 4, 8 or 12 sensor inputs. Up to 12 analogue sensors or up to 40 digital sensors (Modbus RTU).
- **Suitable for industrial applications:** Metal housing IP 65 or panel mounting...
- **Data available through world wide web:** Network-compatible and remote transmission via web-server
- **Mathematical function:** for internal calculations
- **Totaliser function:** for analogue signals
- ...saves time and costs during installation
- **Simple:** DS 500 provides the power supply for the sensors

DS 500 - The intelligent chart recorder of the next generation

Recording of the measured data, indication on a big colour screen, alerting, storage, not to mention remote read-out via webserver... this is all possible with DS 500.

All measured values, measurement curves and threshold value exceedances are indicated. The curve progressions from the beginning of the measurement can be viewed by an easy slide of the finger.

The big difference to ordinary paperless chart recorders reveals in the easy initiation and in the evaluation of the measured data. All sensors are identified directly and powered by DS 500. Everything is matched and tuned.

Mathematical function for internal calculations, e.g. the typical figures of a compressed air system:

- Costs in € per generated m³ air
- kWh/m³ generated air
- Consumption of single lines including summation

Totaliser function for analogue signals (e.g. 0/4...20 mA, 0...10 V). In case of third-party sensors which e.g. only give a 4...20 mA signal for the actual flow in m³/h, a total counter reading in m³ can be generated by means of the totaliser function.

No time consuming studying of the instruction manual... this saves time. Internal voltage supply of all sensors, no wiring of external mains units ... this saves additional costs.



Flow meters for compressed air and gases

- Installation and removal under pressure via standard 1/2" ball valve
- A safety ring prevents the uncontrolled ejection in case of installation/removal under pressure
- Usable for different gases: Compressed air, nitrogen, argon, CO₂, oxygen...



Dew point sensors

- Extremely stable in the long term
- Quick adaption time
- Large measuring range (-80° to +20 °Ctd)
- For all dryers: (Adsorption dryers, membrane dryers and refrigeration dryers)
- Easy installation under pressure via the measuring chamber with quick coupling



Pressure sensors

- Large selection of pressure sensors with different measuring ranges for each measuring purpose
- Quick installation under pressure by quick coupling
- Pressure probe 0-10/16/40/100/250/400 bar overpressure
- Pressure probe -1 to +15 bar (underpressure/overpressure)
- Differential pressure 0...1.6 bar
- Absolute pressure 0 - 1.6 bar (abs)



- Large selection of temperature sensors e.g. for measurement of the ambient temperature or gas temperature
- Pt100 (2-wire or 3-wire)
- Pt1000 (2-wire or 3-wire)
- Temperature sensors with measuring transducer (4-20 mA output)



Temperature sensors



- Monitoring of compressed air quality according to ISO 8573
- Residual oil, particles, residual moisture



Compressed air quality measurement



- CS PM5110 current/effective power meters for panel mounting
- External current transformers for encompassing the phases (max. 2000 A)
- Measures kW, kWh, cos phi, kVar, kVA
- Data transfer DS 500 via Modbus



Current/effective power meters

By means of the intelligent chart recorder **DS 500**, all measuring data of a compressor station can be recorded, indicated and evaluated.

At **12 freely assignable sensor inputs**, all our sensors can be connected as well as any optional **third-party sensors and meters with the following signal outputs:**

4-20 mA, 0-20 mA | 0-1 V / 0-10 V / 0-30 V | Pt 100 (2- or 3-wire), Pt 1000 (2- or 3-wire), pulse outputs (e.g. of gas meters) | Modbus protocol.



Measured values, statistics, curves with the 7" colour screen with touch panel

A1 Compressed Air		A2 Compressed Air		A3 Compressed Air		A4 Compressed Air	
<input checked="" type="checkbox"/> A1a	237.7 m³/h	<input checked="" type="checkbox"/> A2a	729.702 m³/h	<input checked="" type="checkbox"/> A3a	537.0 m³/h	<input checked="" type="checkbox"/> A4a	254.7 m³/h
<input checked="" type="checkbox"/> --	34106 m³	<input checked="" type="checkbox"/> --	13423271 m³	<input checked="" type="checkbox"/> --	155132 m³	<input checked="" type="checkbox"/> --	55234063 m³
B1 Nitrogen		B2 Nitrogen		B3 Nitrogen		B4 Nitrogen	
<input checked="" type="checkbox"/> B1a	337.7 ltr/min	<input checked="" type="checkbox"/> B2a	657.7 ltr/min	<input checked="" type="checkbox"/> B3a	15.7 ltr/min	<input checked="" type="checkbox"/> B4a	237.7 ltr/min
<input checked="" type="checkbox"/> --	27734 ltr	<input checked="" type="checkbox"/> --	240041 ltr	<input checked="" type="checkbox"/> --	34131 ltr	<input checked="" type="checkbox"/> --	235322 ltr
C1 Oxygen		C2 Oxygen		C3 Oxygen		C4 Oxygen	
<input checked="" type="checkbox"/> C1a	17.7 ltr/min	<input checked="" type="checkbox"/> C2a	37.7 ltr/min	<input checked="" type="checkbox"/> C3a	223.7 ltr/min	<input checked="" type="checkbox"/> C4a	75.8 ltr/min
<input checked="" type="checkbox"/> --	4080 ltr	<input checked="" type="checkbox"/> --	234108 ltr	<input checked="" type="checkbox"/> --	3749 ltr	<input checked="" type="checkbox"/> --	43584 ltr
Zurück		Virtuelle Kanäle		Alarm	Lg.stop	days, inte...	24.03.2014
					Rp.run		16:41:52

Actual measured values

All measured values can be seen at a glance. Threshold value exceedances are indicated in red color. A „measuring site name“ can be allocated to each sensor.

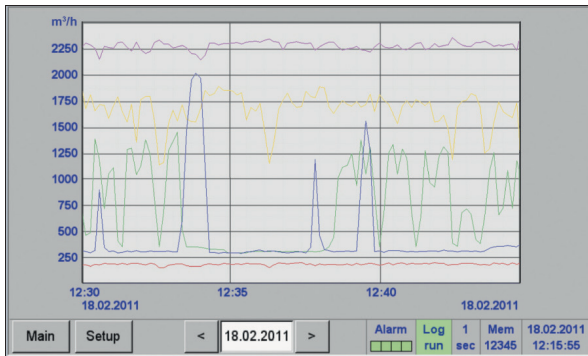

Graphic display

This display replaces the former evaluation of ordinary paper chart recorders and offers lots of advantages. The time axis can be moved by a finger slide. The „zoom function by finger movement“ which enables an analysis of peak values is unique.

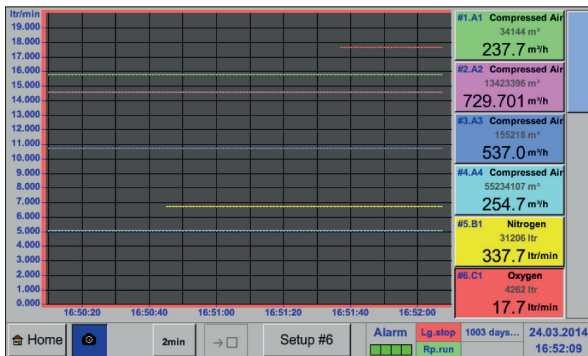

Actual measured values and graphic

Additionally to the measurement curves, the current measured values are indicated as well.

Alarm settings for channel A1 (DewPoint)

	Value °C/d	Hysteresis +/-	Relay			
Upper limit			1	2	3	4
<input checked="" type="checkbox"/> Alarm 1	-40.000	- 0.500				
<input checked="" type="checkbox"/> Alarm 2	-30.000	- 0.500				
Lower limit						
<input type="checkbox"/> Alarm 1	0.000	+ 0.000				
<input type="checkbox"/> Alarm 2	0.000	+ 0.000				

OK Cancel Setup Delay

Adjustment of the alarm relays

Each one of the four alarm relays can be allocated individually to a connected sensor. The alarm thresholds and the hysteresis can be freely adjusted.

New: It is possible to set an alarm delay for each alarm relay so that the relay is only triggered after that period of time.



Technical data of the DS 500

TECHNICAL DATA DS 500

Dimensions of housing:	280 x 170 x 90 mm, IP 65
Connections:	18 x PG for sensors and supply
Version panel mounting:	Cutout panel 250 x 156 mm
Weight:	3,5 kg
Material:	Die cast metal, front screen polyester
Sensor inputs:	<ul style="list-style-type: none"> • 4/8/12 sensor inputs for analogue and digital sensors; freely allocatable. See options • Digital CS sensors for dew point and consumption with SDI interface FA/VA series, • Digital third-party sensors RS 485 / Modbus RTU, other bus systems realizable on request. • Analogue CS Sensors for pressure, temperature, clamp-on ammeters pre-configured. • Analogue third-party sensors 0/4...20 mA, 0...1/10/30 V, pulse, Pt 100 / Pt 1000, KTY
Voltage supply for sensor:	24 VDC, max. 130 mA per sensor, integrated mains unit max. 24 VDC, 25 W. In case of version 8/12 sensor inputs, 2 integrated mains units each max. 24 VDC, 25 W.
Interfaces:	USB stick, Ethernet / RS 485 Modbus-RTU / TCP, SDI other bus systems on request, webserver optional
Outputs:	<ul style="list-style-type: none"> • 4 relays (changeover contact 230 VAC, 6 A), alarm management, relays freely programmable, collective alarm • Analog output, pulse in case of sensors with own signal output looped, such as e.g. VA/FA series
Memory card:	Memory size 16 GB Micro SD card
Power supply:	100...240 VAC / 50-60 Hz, special version 24 VDC
Colour screen:	7" touch panel TFT transmissive, graphics, curves, statistics
Accuracy:	See sensor specifications
Operating temperature:	0...50 °C
Storage temperature:	-20...70 °C
Optional:	Web server

DESCRIPTION	ORDER NO.
DS 500 - intelligent chart recorder in basic version (4 sensor inputs)	0500 5000
Option: 4 additional sensor inputs for DS 500 V2	Z500 5501
Option: 8 additional sensor inputs for DS 500 V2	Z500 5502
Option: Integrated webserver	Z500 5003
Option: version for panel mounting	Z500 5006
Option: Power supply 24 VDC (instead of 100...240 VAC)	Z500 5007
Option: "Mathematics calculation function" for 4 freely selectable channels, (virtual channels): addition, subtraction, division, multiplication	Z500 5008
Option: "Totaliser function for analogue signals"	Z500 5009
External Gateway Profibus for connecting an integrated RS 485 interface	Z500 3008
CS Basic – data evaluation graphically and in tabular form - reading of the measured data via USB or Ethernet, license for 2 workstations	0554 8040
CS Network – energy monitoring with client/server solution (max. 20 measured values of different sensors/devices)	0554 8041
CS Network – energy monitoring with client/server solution (max. 50 measured values of different sensors/devices)	0554 8042
CS Network – energy monitoring with client/server solution (max. 100 measured values of different sensors/devices)	0554 8043
CS Network - Energy Monitoring with Client / Server Solution (max. 200 measured values of different sensors / devices)	0554 8044

Matching sensors can be found on pages 20 to 23

INPUT SIGNALS

Current signals	(0...20 mA/ 4...20 mA)
Internal or external power supply	
Measuring range	0...20 mA
Resolution	0.0001 mA
Accuracy	± 0.03 mA ± 0.05 %
Input resistance	50 Ω
Voltage signal	(0...1 V)
Measuring range	0...1 V
Resolution	0.05 mV
Accuracy	± 0.2 mV ± 0.05 %
Input resistance	100 kΩ
Voltage signal	(0...10 V / 30 V)
Measuring range	0...10 V
Resolution	0.5 mV
Accuracy	± 2 mV ± 0.05 %
Input resistance	1 MΩ
RTD Pt 100	
Measuring range	-200...850 °C
Resolution	0.1 °C
Accuracy	± 0.2 °C (-100...400 °C) ± 0.3 °C (further range)
RTD Pt 1000	
Measuring range	-200...850 °C
Resolution	0.1 °C
Accuracy	± 0.2° (-100...400 °C)
Pulse	
Measuring range	Min pulse length 500 µs frequency 0...1 kHz max. 30 VDC



DS 400 - Chart recorder

for all relevant parameters of compressed air



Standard equipment:

- USB interface
- 3.5" graphic display with touch screen
- Integrated mains unit for supply of the sensors
- 4...20 mA analogue output of all connected active sensors
- Pulse output (for total consumption) in case of flow sensors
- 2 alarm relays (pot.-free changeover contacts, max. 230 V, 3 A)







Software options:

- Integrated webserver
- Mathematics calculation function
- Totaliser function

Hardware options:

- Integrated data logger
- Ethernet / RS 485 interface
- Additional sensor inputs (digital or analogue) selectable

The sensor inputs 1 and 2 and 3 and 4 can be selected according to the required sensors (see table pages 20 to 21):

Digital	Digital	Digital	Digital	Digital	Analogue	Analogue	Analogue	Analogue
m ³ /h, m ³	°Ctd	A, kWh		bar	A	°C	°C	
								4...20 mA 0...20 mA 0...10 V Pulse Pt 100 Pt 1000
Flow sensor	Dew point sensor	Current/effective power meter	Third-party sensors with RS 485	Pressure sensor	Clamp-on ammeter	Temperature sensor	Third party sensor analogue output	



Panel mounting

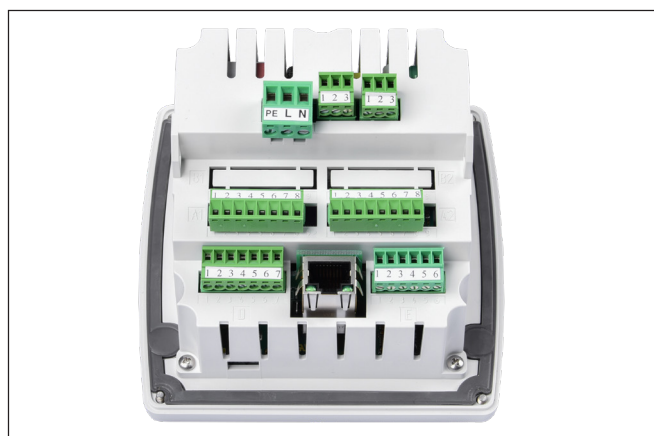

Back view

TECHNICAL DS 400

Dimensions:	118 x 115 x 98 mm IP 54 (wall housing) 92 x 92 x 75 mm (panel mounting)
Inputs:	2 digital inputs for FA 5xx resp. VA 5xx
Interface:	USB interface
Power supply:	100...240 VAC, 50-60 Hz
Accuracy:	See sensor specifications
Alarm outputs:	2 relays, (pot.-free)
Options:	
Data logger:	100 million measured values start/stop time, measuring rate freely adjustable
2 additional sensor inputs:	For connection of pressure sensors, temperature sensors, clamp-on ammeters, third-party sensors with 4...20 mA, 0 to 10 V, Pt 100, Pt 1000

DESCRIPTION		ORDER NO.	
DS 400 - Chart recorder with graphic display and touch screen	Sensor input 1+2	Sensor input 3+4	
	Digital (Z500 4003)	-----	0500 4000 D
	Digital (Z500 4003)	Digital (Z500 4003)	0500 4000 DD
	Digital (Z500 4003)	Analogue (Z500 4001)	0500 4000 DA
	Analogue (Z500 4001)	-----	0500 4000 A
	Analogue (Z500 4001)	Analogue (Z500 4001)	0500 4000 AA
Options:			
Option: Integrated data logger for 100 million measured values		Z500 4002	
Option: Integrated Ethernet and RS 485 interface		Z500 4004	
Option: Integrated webserver		Z500 4005	
Option: "Mathematics calculation function" for 4 freely selectable channels, (virtual channels): addition, subtraction, division, multiplication		Z500 4007	
Option: "Totaliser function for analogue signals"		Z500 4006	
External Gateway Profibus for RS 485 interface connection		Z500 3008	
Further accessories:			
CS Basic – data evaluation graphically and in tabular form - reading of the measured data via USB or Ethernet, license for 2 workstations		0554 8040	
CS Network – energy monitoring with client/server solution (max. 20 measured values of different sensors/devices)		0554 8041	
CS Network – energy monitoring with client/server solution (max. 50 measured values of different sensors/devices)		0554 8042	
CS Network – energy monitoring with client/server solution (max. 100 measured values of different sensors/devices)		0554 8043	
CS Network - Energy Monitoring with Client / Server Solution (max. 200 measured values of different sensors / devices)		0554 8044	

INPUT SIGNALS

Current signals internal or external power supply Measuring range Resolution Accuracy Input resistance	(0...20 mA/4...20 mA)
Voltage signal: Measuring range Resolution Accuracy Input resistance	(0...1 V) 0...1 V 0.05 mV ± 0.2 mV ± 0.05 % 100 kΩ
Voltage signal Measuring range Resolution Accuracy Input resistance	(0...10 V / 30 V) 0...10 V 0.5 mV ± 2 mV ± 0.05 % 1 MΩ
RTD Pt 100 Measuring range Resolution Accuracy	-200...850 °C 0.1 °C ± 0.2 °C (-100...400 °C) ± 0.3 °C (further range)
RTD Pt 1000 Measuring range Resolution Accuracy	-200...850 °C 0.1 °C ± 0.2° (-100...400 °C)
Pulse Measuring range	Min pulse length 500 µs frequency 0...1 kHz max. 30 VDC



DS 500 / DS 400

Easy operation via touchscreen:

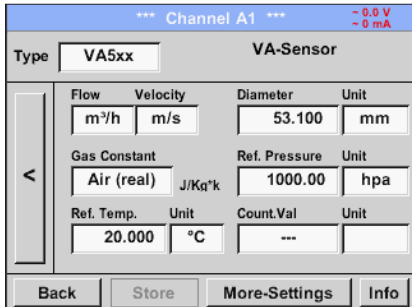

Configuration of flow sensor

In the menu of the DS 500 / DS 400, the flow sensor VA 5xx can be set to the respective pipe inside diameter. Furthermore, the unit, the gas type and the reference condition can be set. The meter reading can be set to "zero" if necessary.

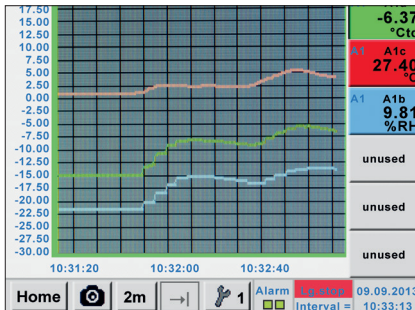

Graphic view

In the graphic view all measured values are indicated as curves. It is possible to browse back on the time axis by a slide of the finger (without data logger maximum 24 h, with data logger back to the start of the measurement).

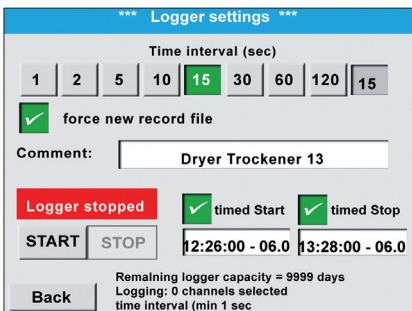

Data logger

With the option „integrated data logger“ the measured values are stored in the DS 500 / DS 400. The time interval can be freely set. Furthermore there is the possibility to fix the starting time and the end time of the data recording. Read-out of the measured data via USB interface or via the optional Ethernet interface.

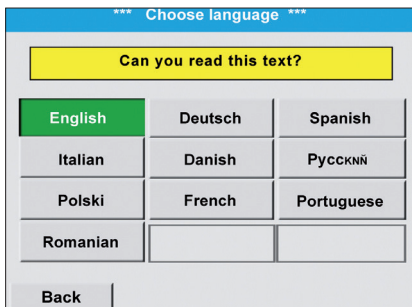

Selection of the language

DS 500 / DS 400 "speaks" several languages. The desired language can be selected via the selection button.

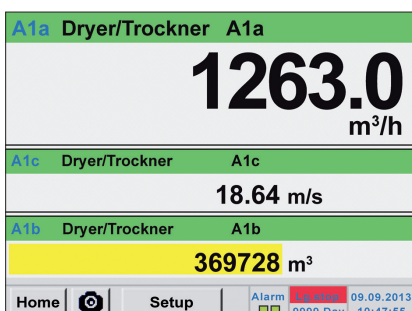

All relevant parameters at a glance

In addition to the flow rate in m³ / h, the DS 500 / DS 400 also displays other parameters such as total consumption in m³ and speed in m/s.



Web server

The new webserver with substantially extended features for the chart recorders DS 500 and DS 400 is available with immediate effect. Users can thereby get direct access to their measured data worldwide (current and historic ones) and display them on their smart phone, tablet or computer.

The new webserver can be ordered as an option with each stationary DS 500/400, but also for their mobile devices. For using the features of the webserver, the DS 500/400 must be set up with it's own IP address within the corporate network.

The web server in the DS 500/400 provides a website, which displays the measured values. This website can be accessed from smartphones, tablets and computers via the respectively installed browser. Advantage: This is all possible without the installation of any new or additional software.



View of the real time measured values (graphic table view)

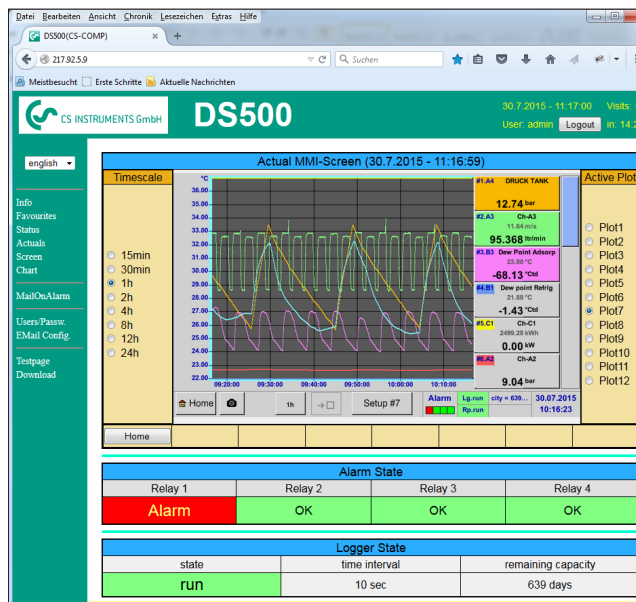

View of the historic measured values as a single chart (time period freely selectable)

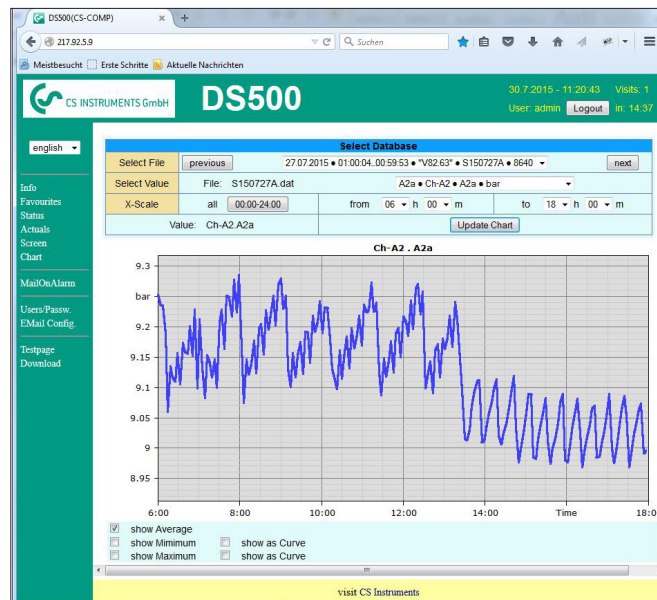

Access authorization

Different groups with different users/passwords can be assigned to different access levels.

Starting the data logger

In case of a stopped data logger the group operator or administrator can start the data logger remotely, via the web server.

PS: The new webserver can be retrofitted to any DS 500/DS 400 already in use.



Suitable sensors for DS 500 / DS 400

Flow meters for installation and removal under pressure (insertion type)

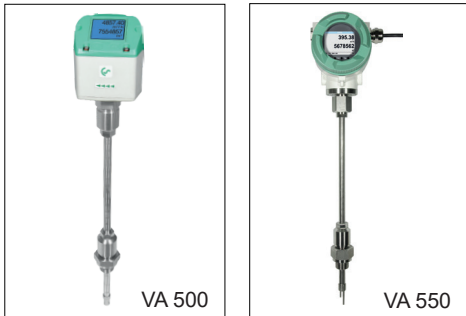

FLOW METERS INSERTION-VERSION

VA 500 meter in basic version:
Standard (92.7 m/s), probe length 220 mm, without display
VA 550 Flow meter, measuring head in robust aluminium die casting housing

ORDER NO.

0695 5001
0695 0550
+ order code
A...M..._

Inline flow meter

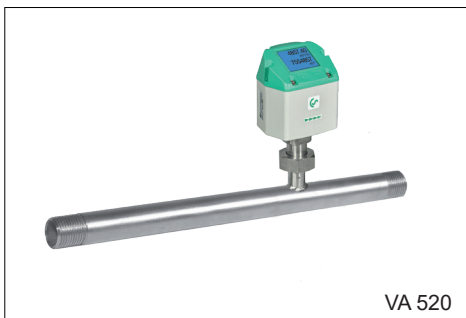

FLOW METERS IN-LINE VERSION

Flow meter VA 520 with integrated measuring section, (R 1/4" DN 8)
Flow meter VA 520 with integrated measuring section, (R 1/2" DN 15)
Flow meter VA 520 with integrated measuring section, (R 3/4" DN 20)
Flow meter VA 520 with integrated measuring section, (R 1" DN 25)
Flow meter VA 520 with integrated measuring section, (R 1 1/4" DN 32)
Flow meter VA 520 with integrated measuring section, (R 1 1/2" DN 40)
Flow meter VA 520 with integrated measuring section, (R 2" DN 50)

ORDER NO.

0695 0520
0695 0521
0695 0522
0695 0523
0695 0526
0695 0524
0695 0525

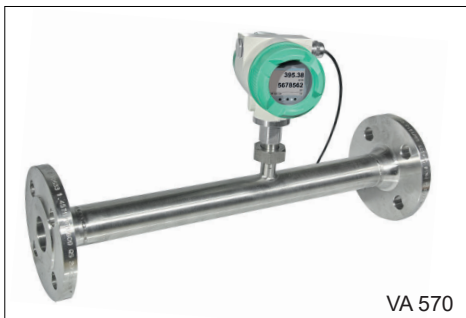

Inline Flow meter VA 570 with integrated 1/2" measuring section

0695 0570
+ order code
A...K_

Flow meter VA 570 with integrated 3/4" measuring section
Flow meter VA 570 with integrated 1" measuring section
Flow meter VA 570 with integrated 1 1/4" measuring section
Flow meter VA 570 with integrated 1 1/2" measuring section
Flow meter VA 570 with integrated 2" measuring section

0695 0571
0695 0572
0695 0573
0695 0574
0695 0575



DEW POINT SENSORS

FA 510 dew point sensor, -80...+20 °Ctd incl. factory certificate
FA 510 dew point sensor, -20...+50 °Ctd incl. factory certificate
Standard measuring chamber for compressed air up to 16 bar

ORDER NO.

0699 0510
0699 0512
0699 3390

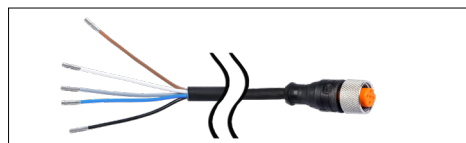

CONNECTION CABLES FOR FLOW METERS/DEW POINT SENSORS VA 500, 520 AND FA 510

Connection cable for VA/FA series, 5 m
Connection cable for VA/FA sensors, 10 m

ORDER NO.

0553 0104
0553 0105

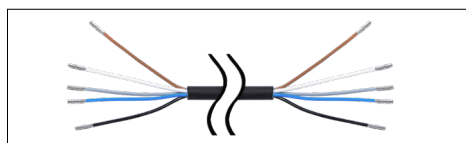

CONNECTION CABLES FOR FLOW METERS VA 550/570:

Connection cable 5 m with open ends
Connection cable 10 m with open ends

ORDER NO.

0553 0108
0553 0109



PRESSURE PROBES WITH 4...20 mA ANALOGUE OUTPUT	± 1%	± 0,5%
	ACCURACY	ACCURACY
Standard pressure probe CS 16, 0...16 bar	0694 1886	0694 3555
Standard pressure probe CS 40, 0...40 bar	0694 0356	0694 3930
Standard pressure probe CS 1.6, 0...1.6 bar abs.		0694 3550
Standard pressure probe CS 10, 0...10 bar	0694 3556	0694 3554
Standard pressure probe CS 100, 0...100 bar		0694 3557
Standard pressure probe CS 250, 0...250 bar		0694 3558
Standard pressure probe CS 400, 0...400 bar		0694 3559
Precision pressure probe CS -1...+15 bar, ± 0.5 % accuracy of. f.s.		0694 3553
Differential pressure probe 1.6 bar diff.		0694 3561
Calibration certificate pressure, 5 calibration points for the whole measuring range		3200 0004



DIGITAL PRESSURE PROBES	± 1%	± 0,5%
	ACCURACY	ACCURACY
Digital pressure probe DPS 16, 0...16 bar RS 485, G1/2"	0694 2886	0694 4555
Digital pressure probe DPS 16, 0...16 bar RS 485, NPT 1/2"	0694 3886	0694 5555



TEMPERATURE SENSORS	ORDER NO.
Screw-in temperature sensor PT 100 class A, length 300 mm, d = 6 mm, with measuring transducer 4...20 mA = -50 °C...+ 550 °C (2-wire)	0604 0201
Outdoor temperature sensor PT 100 class B (2-wire) in wall housing (82x55x33 mm), application range: -50 °C...+80 °C	0604 0203
Room/outdoor temperature sensor with measuring transducer, 4...20 mA (2-wire), measuring range switchable -20 °C...+80 °C / -50 °C...+50 °C	0604 0209
Indoor temperature sensor PT 100 class B (2-wire) in wall housing with ventilation slots (82x55x33 mm), application range: -50 °C...+80 °C	0604 0204
Cable temperature sensor PT 100 class A (4-wire), length: 300 mm, d = 6 mm, -70 ... +260 ° C, 5 m connection cable PFA with open ends	0604 0205
Cable temperature sensor PT 100 class A (4-wire), length: 100 mm, d = 6 mm, -70...+260 °C, 5 m connection cable PFA with open ends	0604 0206
Cable temperature sensor PT 100 class A (4-wire), length: 200 mm, d = 6 mm, -70...+260 °C, 5 m connection cable PFA with open ends	0604 0207
Magnetic surface temperature sensor, holding magnet 39x26x25 mm, PT 100 class B (2-wire), -30...+180 °C, 5 m connection cable PFA with open ends	0604 0208
Compression fittings: 6 mm; G 1/2" PTFE clamping ring pressure-tight up to 10 bar	0554 0200
Material: stainless steel, application area: max. + 260 °C	
Compression fitting; 6 mm; G 1/2" stainless steel clamping ring	0554 0201
Pressure-tight up to 16 bar, material: stainless steel, application area: max. + 260 °C	
Calibration certificate temperature, 2 calibration points	0520 0180

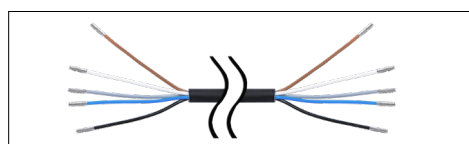
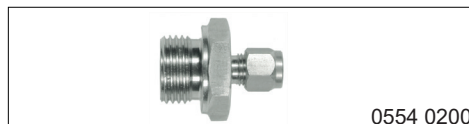

CONNECTION CABLES FOR PRESSURE SENSORS / TEMPERATURE SENSORS	ORDER NO.
Connection cable for probes 5 m with open ends	0553 0108
Connection cable for probes 10 m with open ends	0553 0109



CLAMP-ON AMMETERS	ORDER NO.
Clamp-on ammeter 0...1000 A TRMS incl. 3 m connection cable with open ends	0554 0518
Clamp-on ammeter 0...400 A TRMS incl. 3 m connection cable with open ends	0554 0510



CS PM 5110 - Current/effective power meters for panel mounting

Measures voltage, current and calculates:

- Effective power [kW]
- Apparent power [kVA]
- Reactive power [kVar]
- Active energy [kWh]
- cos phi

All measured data are transmitted digitally (Modbus) to the DS 500 and can be recorded there.

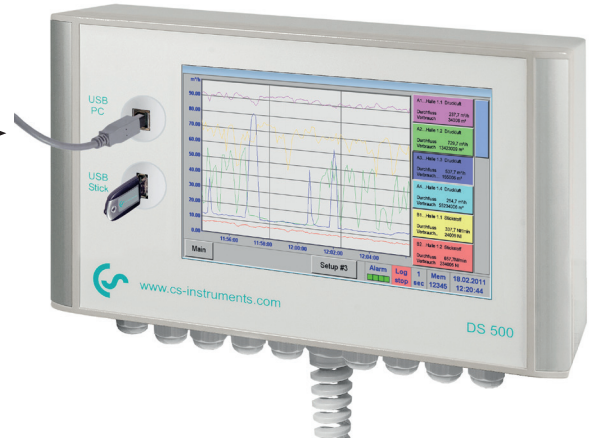
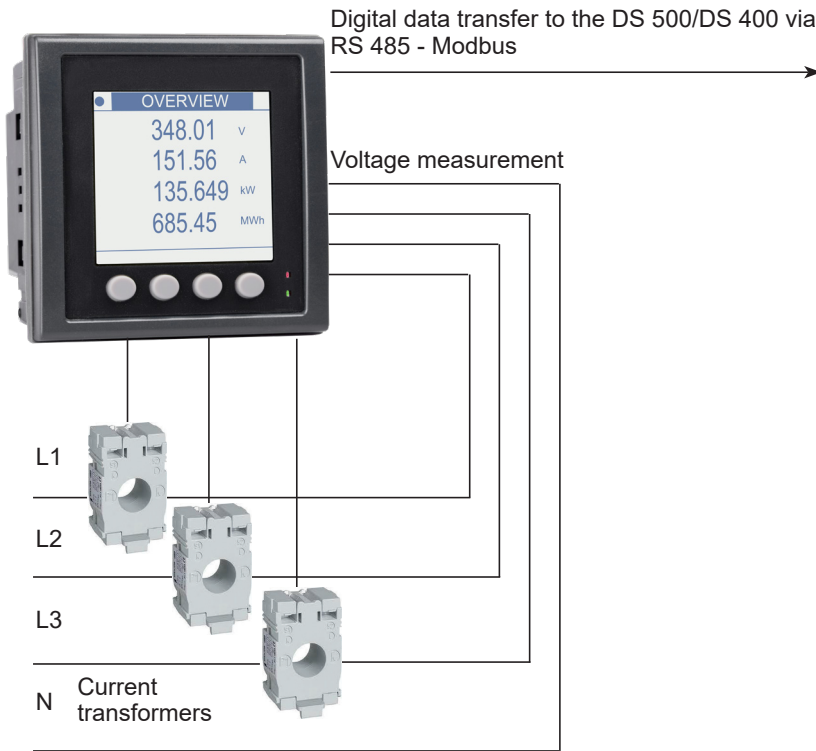

DESCRIPTION	ORDER NO.
CS PM5110 Current/effective power meters for panel mounting, with RS485 interface	0554 5357
Install-construction for the CS PM5110, on top hat rail	0554 5356
Current transformer 100/5 A connectable to current/effective power meter for panel mounting (for cables up to Ø 21 mm)	0554 5344
Current transformer 200/5 A connectable to current/effective power meter for panel mounting (for cables up to Ø 21 mm)	0554 5345
Current transformer 300/5 A connectable to current/effective power meter for panel mounting (for cables up to Ø 22 mm)	0554 5346
Current transformer 500/5 A connectable to current/effective power meter for panel mounting (for cables up to Ø 22 mm)	0554 5347
Current transformer 600/5 A connectable to current/effective power meter for panel mounting (for cables up to Ø 22 mm)	0554 5348
Current transformer 1000/5 A connectable to current/effective power meter for panel mounting (for current bar up to 65 x 32 mm)	0554 5349
Current transformer 2000/5 A connectable to current/effective power meter for panel mounting (for current bar up to 127 x 38 mm)	0554 5350
Connection cable for probes 5 m, with open ends	0553 0108
Connection cable for probes 10 m, with open ends	0553 0109

TECHNICAL DATA PM5110

Parameters:	Voltage (Volt) Current (Ampere) Cos phi Effective power (kW) Apparent power (kVA) Reactive power (kVar) Active energy (kWh) Power frequency (Hz) All parameters are transferred digitally to DS 500/DS 400.
Accuracy current measurement:	± 0.5% from 1 to 6 A
Accuracy voltage:	± 0.5% from 50 V to 277 V
Accuracy active energy:	IEC 62053-21 Class 1
Interfaces:	RS 485 (Modbus protocol)
Measuring range:	Voltage measurement max. 600 VAC
Dimensions:	96 x 96 x 78.5 mm (W x H x D)
Operating temperature:	-10...+55 °C



CS PM Flex - Current/effective power meter with Rogowski Coils

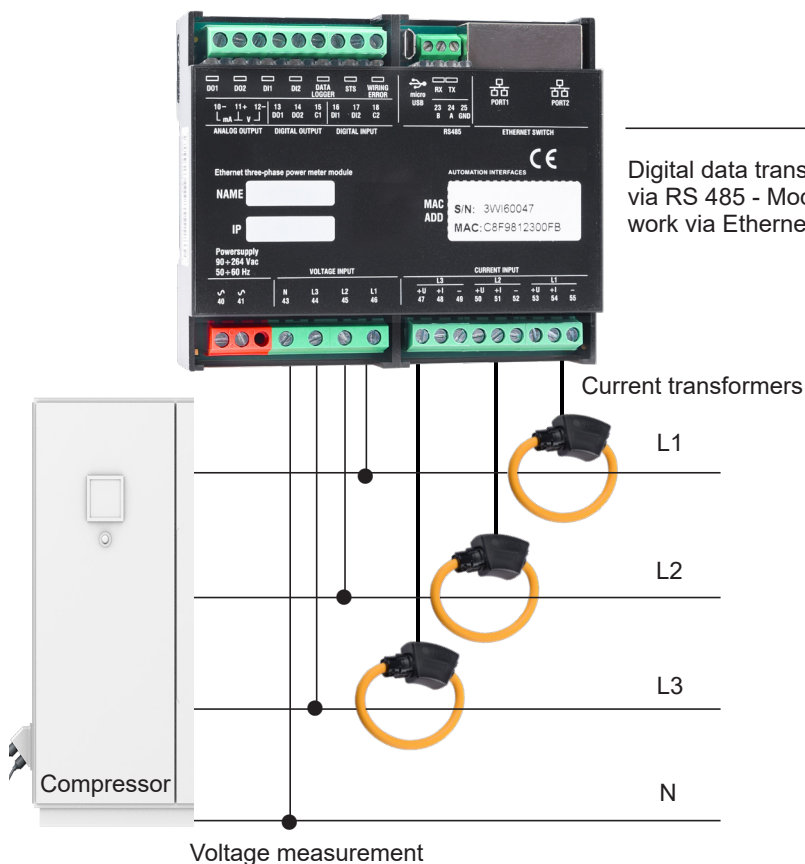

Digital data transfer to the DS 500 via RS 485 - Modbus or CS Network via Ethernet (Modbus TCP)

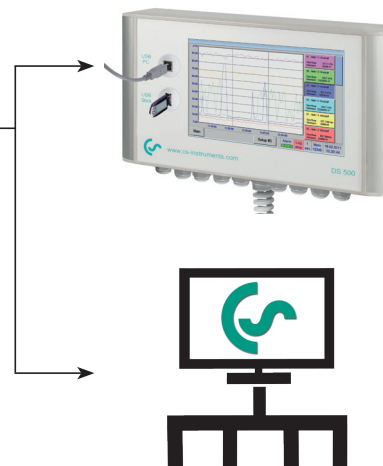

Measures voltage, current and calculates:

- Effective power [kW]
- Apparent power [kVA]
- Reactive power [kVar]
- Active energy [kWh]
- cos phi

Rogowski Coil:

The split coil bobbin allows subsequent, quick and easy installation

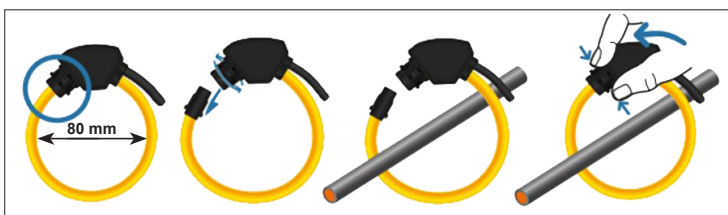

Accuracy range:

C: Conductor in centred position

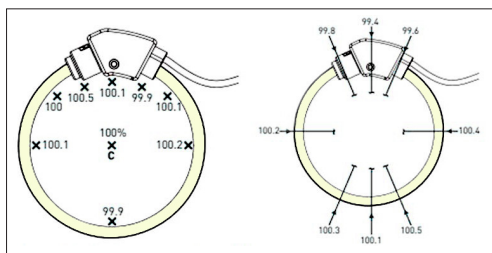

TECNICAL DATA CS PM Flex

Parameters:	Voltage (Volt) Current (Ampere) Cos phi Effective power (kW) Apparent power (kVA) Reactive power (kVar) Active energy (kWh) Power frequency (Hz) All parameters are transferred digitally to DS 500/ CS Network.
Measuring range:	Voltage measurement: max. 600 VAC, 45-65 Hz Current measurement: 10 - 3000 A @ 50 Hz 10 - 2500 A @ 60 Hz
Accuracy	
Current measurement / active energy:	± 0,5%
Accuracy voltage measurement:	± 0,2 %
Interfaces:	RS 485 and Ethernet
Dimensions:	90 x 107 x 32 mm (B x H x T)
Operating temperature:	-25...+55 °C

DESCRIPTION	ORDER NO.
CS PM Flex Current/effective power meters for top-hat rail mounting, with RS485 and Ethernet interface	0554 5358
Rogowski Coil (Ø 80 mm) connectable to CS PM Flex incl. 3 m connection cable with open ends	0554 5359



DS 500 mobile - Intelligent mobile chart recorder

The intelligent chart recorder of the future - energy analysis according to DIN EN 50001
Energy analysis - consumption measurement - leakage calculation at compressed air systems

Advantages at a glance:

- Easy operation via 7" colour screen with touch panel

Versatile:

- Up to 12 sensors / meters can be connected, including third-party sensors / counters incl. power supply

Reliable:

- Reliably stores all measured values on a memory card. Easy reading out via USB stick possible

Intelligent energy analysis:

- Costs in € per generated m³ air
- kWh/m³ generated air
- Consumption of single lines including summation





Technical data of DS 500 mobile

TECHNICAL DATA DS 500 MOBILE		INPUT SIGNALS	
Case dimensions	360 x 270 x 150 mm	Current signal internal or external power supply	(0...20 mA/4...20 mA)
Weight:	4.5 kg	Measuring range	0...20 mA
Material:	Diecast, front foil polyester, ABS	Resolution	0.0001 mA
Sensor inputs:	4/8/12 sensor inputs for analogue and digital sensors; freely allocatable. See options Digital CS sensors for dew point and flow with SDI interface FA/VA series, digital third-party sensors RS485 / Modbus RTU. Analogue CS Sensors for pressure, temperature, clamp-on ammeters preconfigured. Analogue third-party sensors 0/4...20 mA, 0...1/10/30 V, pulse, Pt 100 / Pt 1000, KTY, counter	Accuracy	± 0.03 mA ± 0.05 %
Voltage supply for sensor:	24 VDC, max. 130 mA per sensor, integrated mains unit, max. 24 VDC, 25 W. For version 8/12 sensor inputs 2 integrated mains units, each max. 24 VDC, 25 W	Input resistance	50 Ω
Interfaces:	USB stick, Ethernet / RS 485 Modbus RTU / TCP, SDI other bus systems on request, webserver optionally, GSM module	Voltage signal	
Memory card:	Memory size 16 GB Micro SD memory card	Measuring range	(0...1 V)
Power supply:	100...240 VAC, 50-60 Hz	Resolution	0...1 V
Colour screen:	7" touch panel TFT transmissive, graphics, curves, statistics	Accuracy	0.05 mV
Accuracy:	Please see sensor specifications	Input resistance	± 0.2 mV ± 0.05 % 100 kΩ
Operating temperature:	0...50 °C	Voltage signal	
Storage temperature:	-20...70 °C	Measuring range	(0...10 V / 30 V)
		Resolution	0...10 V
		Accuracy	0.5 mV
		Input resistance	± 2 mV ± 0.05 % 1 MΩ
		RTD Pt 100	
		Measuring range	-200...850 °C
		Resolution	0.1 °C
		Accuracy	± 0.2 °C (-100...400 °C) ± 0.3 °C (further range)
		RTD Pt 1000	
		Measuring range	-200...850 °C
		Resolution	0.1 °C
		Accuracy	± 0.2° (-100...400 °C)
		Pulse	
		Measuring range	Min pulse length 100 μs frequency 0...1 kHz max. 30 VDC

DESCRIPTION	ORDER NO.
Intelligent chart recorder DS 500 mobile, 4 sensor inputs	0500 5012
Intelligent chart recorder DS 500 mobile, 8 sensor inputs	0500 5013
Intelligent chart recorder DS 500 mobile, 12 sensor inputs	0500 5014
Option: "Integrated webserver"	Z500 5003
Option: "Mathematics calculation function" for 4 freely selectable channels, (virtual channels): addition, subtraction, division, multiplication	Z500 5008
Option: "Totaliser function for analogue signals"	Z500 5009
CS Basic - data evaluation in graphic and table form - read-out of the measured data via USB or Ethernet. License for 2 working places	0554 8040
CS Soft Energy Analyzer for energy and leakage analysis of compressed air stations	0554 7050
Connection cable for pressure, temperature and third-party sensors to mobile devices, ODU/open ends, 5 m	0553 0501
Connection cable for pressure, temperature and third-party sensors to mobile devices, ODU/open ends, 10 m	0553 0502
Connection cable for VA / FA sensors to mobile devices, ODU/M12, 5 m	0553 1503
Extension cable for mobile devices, ODU/open ends, 10 m	0553 0504
Case for all sensors (dimensions: 500 x 360 x 120 x mm)	0554 6006

Further sensors can be found on pages 38 to 41



DS 500 mobile - Intelligent mobile chart recorder

The intelligent chart recorder of the future - energy analysis according to DIN EN 50001

If we talk about operating costs in compressed air systems, we are actually talking about the energy costs, because the electricity costs make up about 70-80% of the total cost of a compressed air system.

Depending on the size of the system, this means considerable operating costs. Even in smaller systems, this may quickly add up to €10,000 to 20,000 per year. This is an amount which can be considerably reduced - even in the case of well operated and maintained plants.

Does this also apply to your compressed air system? Which are your actual costs per generated m³ air? Which energy is gained due to the waste heat recovery? What is the total performance balance of your plant? How high are the differential pressures of single filters, how high is the humidity (pressure dew point), how much compressed air is used?

By means of the new intelligent chart recorder DS 500 mobile and the suitable sensors and meters all these questions can be answered easily. For example by means of a long-term measurement over 7 days, data recording and evaluation on the PC.



Touch screen



12 sensor inputs

Including voltage supply for all sensors



USB stick



Ethernet connection





Sensors for DS 500/DS 400 mobile

Flow meters for compressed air and gases

- Installation and removal under pressure via standard 1/2" ball valve
- A safety ring prevents the uncontrolled ejection in case of installation/removal under pressure
- Usable for different gases: Compressed air, nitrogen, argon, CO₂, oxygen



Dew point sensors

- Extremely stable in the long term
- Quick adaption time
- Large measuring range (-80° to +20 °Ctd)
- For all dryers: (Adsorption dryers, membrane dryers and refrigeration dryers)
- Easy installation under pressure via the standard measuring chamber with quick coupling



Pressure sensors

- large selection of pressure sensors with different measuring ranges for each measuring purpose
- Quick installation under pressure by quick coupling
- Pressure sensor 0-10/16/40/100/250/400 overpressure
- Pressure probe -1 to +15 bar (underpressure/overpressure)
- Differential pressure 0...1.6 bar
- Absolute pressure 0 - 1.6 bar (abs)



Temperature sensors

- Large selection of temperature sensors e.g. for measurement of the ambient temperature or gas temperature
- Pt100 (2-wire or 3-wire)
- Pt1000 (2-wire or 3-wire)
- Temperature sensors with measuring transducer (4-20 mA output)



- Monitoring of compressed air quality according to ISO 8573
- Residual oil, particles, residual moisture



Compressed air quality measurement



- Particle counter PC 400 in a service case
- up to 0.1 µm or
- up to 0.3 µm



Compressed air quality measurement



- For the analysis of compressors (load and idle times, energy consumption, on/off cycles) the current consumption of up to 12 compressors is recorded by clamp-on ammeter
- Measuring range of the clamp-on ammeters:

0 - 400 A
0 - 1000 A



Clamp-on ammeters



- **CS PM 600** mobile current/effective power meter with external current transformers for large machines and systems
- External current transformers for encompassing the phases (100 A or 600 A)
- External magnetic measuring tip for measuring the voltage
- Measures KW, kWh, cos phi, kVar, kVA
- Data transmission **DS 500 mobile** via Modbus



Current/effective power meters

By means of the mobile chart recorder **DS 500 mobile**, all measuring data of a compressor station can be recorded, indicated and evaluated.

At **12 freely assignable sensor inputs**, all our sensors can be connected as well as any optional **third-party sensors and meters with the following signal outputs:**

4-20 mA, 0-20 mA I 0-1 V / 0-10 V / 0-30 V I Pt 100 (2- or 3-wire), Pt 1000 (2- or 3-wire), KTY I pulse outputs (e.g. of gas meters) I Modbus protocol



DS 500 PM mobile – Efficiency measurement for compressors

All-in-one measurement: electrical energy, pressure, dew point, temperature and consumption

Besides common measurements such as compressed air consumption or humidity, even more complex measurement tasks can be tackled with this all-round mobile device. With the DS 500 PM mobile, conducting an energy analysis according to DIN ISO 50001 is child's play.

Its clear, simple operating method makes it possible, for example, to carry out an analysis of compressed air costs by simultaneously measuring energy consumption (kW/kWh) and compressor output (m³/m³/h). And the data logger with its integrated effective power meter is perfect for auditors or service technicians.

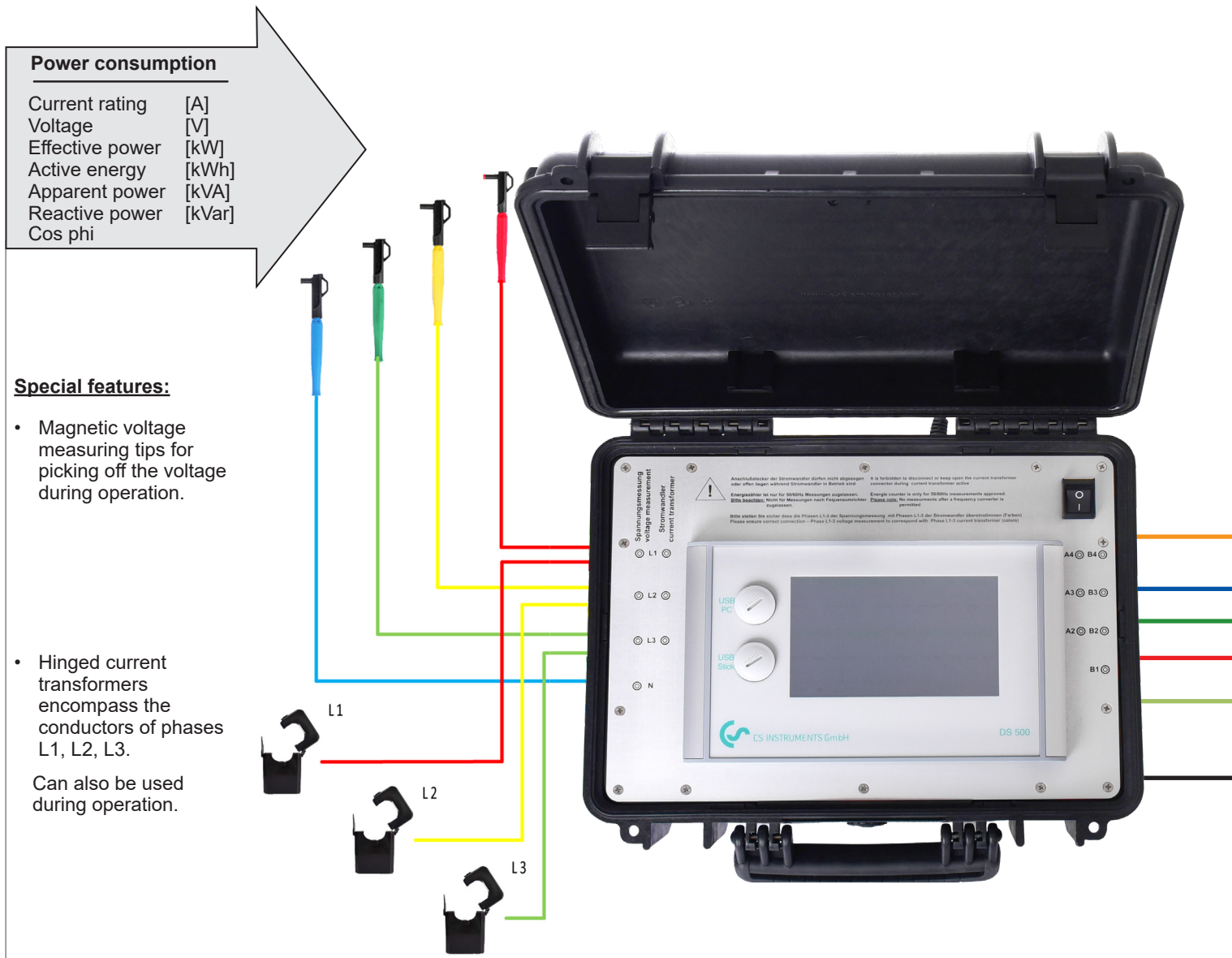

For universal use:

- Up to 11 devices can be connected, including third-party sensors incl. power supply

Reliable:

- Reliably stores all measured values on a memory card. Easy readout possible via USB stick

Energy analysis according to DIN ISO 50001:

- Costs in EUR per m³ air generated
- Specific output in kWh/m³
- Consumption of single lines including summation



Flow meters for compressed air and gases

- Can be installed and removed under pressure via standard 1/2" ball valve
- A safety ring prevents uncontrollable ejection during installation/removal under pressure
- Can be used with different gases: compressed air, nitrogen, argon, CO₂, oxygen



Compressed air consumption

Dew point sensors

- Extreme long-term stability
- Short adaption time
- Wide measuring range (-80° to +20° Ctd)
- For all dryers: (adsorption dryers, membrane dryers and refrigeration dryers)
- Easy to install under pressure using the standard measuring chamber with quick coupling



Pressure dew point

Pressure sensors

- Large selection of pressure sensors with different measuring ranges for each measuring purpose
- Quick to install under pressure by quick coupling
- Pressure sensor 0-10/16/40/100/250/400 overpressure
- Pressure probe -1 to +15 bar (underpressure/overpressure)
- Differential pressure 0...1.6 bar
- Absolute pressure 0 - 1.6 bar (abs)



Pressure

Temperature sensors

- Large selection of temperature sensors e.g. for measurement of the ambient temperature or gas temperature
- Pt 100 (2-wire or 3-wire)
- Pt 1000 (2-wire or 3-wire)
- Temperature sensors with measuring transducer (4-20 mA output)



Temperature

Compressed air quality

- Monitoring of compressed air quality according to ISO 8573
- Residual oil, particles, residual moisture
- Particle counter PC 400 in service case up to 0.1 µm or up to 0.3 µm



Residual oil/particles



Mobile electricity/effective power meter
CS PM 600

Compressed air generated

- Compressed air flow [m³]
- Pressure dew point [° Ctd]
- Pressure [bar]
- Temperature [° C/°F]
- Residual oil content [mg/m³]
- Particle content [Cts/m³]

With one or more additional electricity/effective power meters, it is possible to carry out efficiency measurements of several compressors simultaneously.



Analysis of specific power:

By measuring power consumption and delivery volume simultaneously, it is possible to calculate the specific power of the compressor. The specific power is calculated using the ratio of the required energy consumption in kWh to the volume of air in m³ output during the same period.

$$\text{Specific power} = \frac{kWh}{m^3}$$

The specific performance indicator of the compressor supplies information about the compressor's characteristics. The 'traffic light' graphic below can be used as an aid to assessment:

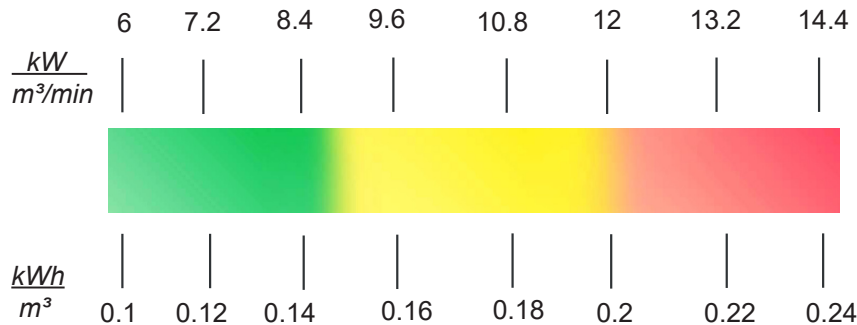

A typical specific power requirement for an oil-injected compressor might look something like this:

Delivery volume: 43.7 Nm³/min
(according to ISO 1217 based on 20° C + 1 bar)

Total power consumption: 272.7 kW

Specific power requirement = 272.7 kW/43.7 m³/min
= 6.24 kWh/m³/min
= 0.104 kWh/m³

DS 500 PM MOBILE TECHNICAL DATA

Case dimensions:	360 x 270 x 150 mm
Weight:	4.5 kg
Material:	Diecast, front foil polyester, ABS
Sensor inputs:	3/7/11 sensor inputs for analogue and digital sensors; freely allocatable. See options Digital CS sensors for dew point and consumption with FA/VA series SDI interface, RS 485/Modbus RTU digital third-party sensors. Analogue CS Sensors for pressure, temperature, clamp-on ammeters preconfigured. Analogue third-party sensors 0/4...20 mA, 0...1/10/30 V, pulse, Pt 100/Pt 1000, KTY
Voltage supply for sensors:	24 VDC, max. 130 mA per sensor, integrated mains unit, max. 24 VDC, 25 W. For 8/12 sensor input version: 2 integrated mains units, each max. 24 VDC, 25 W
Interfaces:	USB stick, Ethernet/RS 485 Modbus RTU/TCP, SDI (other bus systems on request), webserver optional
Memory card:	Micro SD memory card, memory size 16 GB
Power supply:	100...240 VAC, 50-60 Hz
Colour display:	TFT transmissive 7" touch panel, graphics, curves, statistics
Accuracy:	Please see sensor specifications
Operating temperature:	0...50° C
Storage temperature:	-20...70° C



Example order code for DS 500 PM mobile:

0500 5340_A1_B1_C1_D1_E1

Number of additional sensor inputs	
A1	3 inputs
A2	7 inputs
A3	11 inputs

Current transformers – set consisting of 3 transformers (recommendation refers to 400 volt)	
B1	100A/1A – up to 55 kW
B2	600A/1A – up to 340 kW
B3	1000A/1A – up to 600 kW

Mathematics calculation function (4 virtual channels)	
C1	without mathematics calculation functions
C2	with mathematics calculation functions

Totaliser function for analogue signals	
D1	without totaliser function for analogue signals
D2	with totaliser function for analogue signals

Webserver	
E1	without web server
E2	web server integrated

DESCRIPTION	ORDER NO.
DS 500 PM mobile chart recorder with integrated effective power meter for the analysis of compressors and other consumers	0500 5340 + Order code A_...E_
CS Basic – data evaluation in graphic and table form. Readout of measured data via USB or Ethernet. Licensed for 2 work sites	0554 8040
CS Soft Energy Analyzer for energy and leakage analysis of compressed air stations	0554 7050
Connection cable for pressure, temperature and third-party sensors to mobile devices, ODU/open ends, 5 m	0553 0501
Connection cable for pressure, temperature and third-party sensors to mobile devices, ODU/open ends, 10 m	0553 0502
Connection cable for VA/FA sensors to mobile devices, ODU/M12, 5 m	0553 1503
Extension cable for mobile devices, ODU/ODU, 10 m	0553 0504
Case for all sensors (dimensions: 500 x 360 x 120 x mm)	0554 6006



DS 400 mobile - Affordable mobile chart recorder

Energy analysis - consumption measurement - leakage calculation at compressed air systems

Advantages at a glance:

- Easy operation via 3.5" colour screen with touch panel
- Internally rechargeable Li-Ion battery - about 8 hours continuous operation

Versatile:

- Up to 4 sensors / meters can be connected, including third-party sensors / counters incl. power supply

Reliable:

- Reliably stores all measured values on a memory card. Easy reading out via USB stick possible

Intelligent energy analysis:

- Costs in € per generated m³ air
- kWh/m³ generated air
- Consumption of single lines including summation



Up to 4 sensors can be connected including power supply for all sensors

Easy & intuitive in its operation

Saves time & costs on installation



Sensors for DS 500 / DS 400 mobile

Digital	Digital	Digital / Analogue	Analogue
<p>Flow meters for compressed air and gases</p> <ul style="list-style-type: none"> Installation and removal under pressure via standard 1/2" ball valve A safety ring avoids the uncontrolled ejection in case of installation/removal under pressure Usable for different gases: Compressed air, nitrogen, argon, CO₂, oxygen 	<p>Dew point sensors</p> <ul style="list-style-type: none"> Extremely stable in the long term Quick adaption time Large measuring range (-80° to +20 °Ctd) For all dryers: (Adsorption dryers, membrane dryers and refrigeration dryers) Easy installation under pressure via the standard measuring chamber with quick coupling 	<p>Pressure sensors</p> <ul style="list-style-type: none"> Large selection of pressure sensors with different measuring ranges for each measuring purpose Quick installation under pressure by quick coupling Pressure probe 0-10/16/40/100/250/400 overpressure Pressure probe -1 to +15 bar (underpressure/overpressure) Differential pressure 0...1.6 bar Absolute pressure 0 - 1.6 bar (abs) 	<p>Temperature sensors</p> <ul style="list-style-type: none"> Large selection of temperature sensors e.g. for measurement of the ambient temperature or gas temperature Pt 100 (2- or 3-wire) Pt 1000 (2- or 3-wire) Temperature sensors with measuring transducer (4-20 mA output) 
 <ul style="list-style-type: none"> Monitoring of compressed air quality according to ISO 8573 Residual oil, particles, residual moisture 	 <ul style="list-style-type: none"> Particle counter PC 400 in a service case up to 0.1 µm or up to 0.3 µm 	 <ul style="list-style-type: none"> For the analysis of compressors (load and idle times, energy consumption, on/off cycles) the current consumption is recorded by clamp-on ammeter Measuring range of the clamp-on ammeters: <ul style="list-style-type: none"> 0 - 400 A 0 - 1000 A 	 <ul style="list-style-type: none"> CS PM 600 mobile current/effective power meter with external current transformers for large machines and plants External current transformers for encompassing the phases (100 A or 600 A) External magnetic measuring tip for measuring the voltage Measures KW, kWh, cos phi, kVar, kVA Data transmission DS 400 mobile via Modbus 
Compressed air quality measurement	Compressed air quality measurement	Clamp-on ammeters	Current/effective power meters
Analogue	Digital	Analogue	Digital

By means of the chart recorder **DS 400 mobile**, all measured data of a compressor station can be recorded, indicated and evaluated. All sensors of our product range can be connected to the **digital sensor inputs**, e.g.:

flow meters, dew point sensors, current/effective power meters and third-party sensors with Modbus (RS 485).

At **analogue sensor inputs** third party sensors and meters with the following signal output could be connected: 4-20 mA, 0-20 mA | 0-1 V | 0-10 V | 0-30 V | Pt 100 (2- or 3-wire), Pt 1000 (2- or 3-wire), pulse outputs (e.g. of gas meters), Modbus protocol

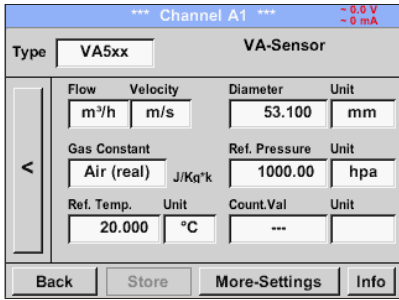

Configuration of flow sensor

In the menu of the DS 500 mobile / DS 400 mobile, the flow meter VA 500 can be set to the respective pipe inside diameter. Furthermore, the unit, the gas type and the reference condition can be set. The meter reading can be set to "zero" if necessary.



Graphic view

In the graphic view all measured values are indicated as curves.

It is possible to browse back on the time axis by a slide of the finger (without data logger maximum 24 h, with data logger back to the start of the measurement).

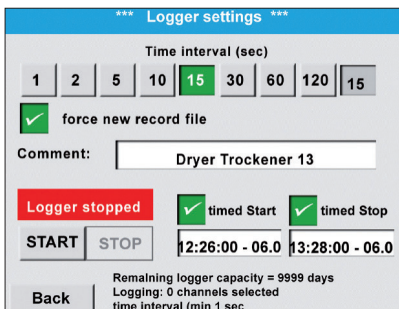

Data logger

With the option "integrated data logger", the measured values are stored in the DS 500/DS 400. The time interval can be freely set. Furthermore there is the possibility to fix the starting time and the end time of the data recording. Read-out of the measured data via USB interface or via the optional Ethernet interface.

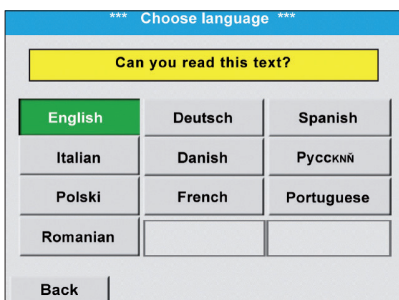

Selection of the language

Many languages are already stored in every DS 500 mobile/ DS 400 mobile. The desired language can be selected via the selection button.

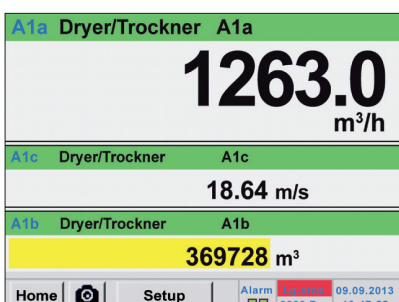

All relevant parameters at a glance

In addition to the flow rate in m³/h, the DS 500 mobile/DS 400 mobile also displays other parameters such as total consumption in m³ and speed in m/s.









Technical data of DS 400 mobile

TECHNICAL DATA DS 400 MOBILE	
Dimensions:	270 x 225 x 156 mm (W x H x D)
Weight:	2.2 kg
Inputs:	2 x 2 sensor inputs for digital or analogue sensor signals
Interface:	USB (standard), Ethernet (optional)
Power supply:	Internal rechargeable Li-Ion batteries, approx 8 h continuous operation, 4 h charging time
Options:	
Integrated data logger:	100 million measured values start/stop time, measuring rate freely adjustable
2 additional sensor inputs:	For connection of pressure sensors, temperature sensors, clamp-on ammeters, third-party sensors with 4...20 mA, 0 to 10 V, Pt 100, Pt 1000

INPUT SIGNALS	
Current signals internal or external power supply Measuring range Resolution Accuracy Input resistance	(0...20 mA/4...20 mA) 0...20 mA 0.0001 mA $\pm 0.03 \text{ mA} \pm 0.05 \%$ 50 Ω
Voltage signal: Measuring range Resolution Accuracy Input resistance	(0...1 V) 0...1 V 0.05 mV $\pm 0.2 \text{ mV} \pm 0.05 \%$ 100 k Ω
Voltage signal Measuring range Resolution Accuracy Input resistance	(0...10 V / 30 V) 0...10 V 0.5 mV $\pm 2 \text{ mV} \pm 0.05 \%$ 1 M Ω
RTD Pt 100 Measuring range Resolution Accuracy	-200...850 $^{\circ}\text{C}$ 0.1 $^{\circ}\text{C}$ $\pm 0.2 \text{ }^{\circ}\text{C}$ (-100...400 $^{\circ}\text{C}$) $\pm 0.3 \text{ }^{\circ}\text{C}$ (further range)
RTD Pt 1000 Measuring range Resolution Accuracy	-200...850 $^{\circ}\text{C}$ 0.1 $^{\circ}\text{C}$ $\pm 0.2 \text{ }^{\circ}\text{C}$ (-100...400 $^{\circ}\text{C}$)
Pulse Measuring range	Min pulse length 500 μs frequency 0...1 kHz max. 30 VDC

DESCRIPTION	Sensor input 1 and 2	Sensor input 3 and 4	ORDER NO.
DS 400 mobile - chart recorder with graphic display, touch screen and integrated data logger	Digital (Z500 4003)	-----	0500 4012 D
	Digital (Z500 4003)	Digital (Z500 4003)	0500 4012 DD
	Digital (Z500 4003)	Analogue (Z500 4001)	0500 4012 DA
	Analogue (Z500 4001)	-----	0500 4012 A
	Analogue (Z500 4001)	Analogue (Z500 4001)	0500 4012 AA
Options:			
Option: Integrated Ethernet and RS 485 interface			Z500 4004
Option: Integrated webserver			Z500 4005
Option: "Mathematics calculation function" for 4 freely selectable channels, (virtual channels): addition, subtraction, division, multiplication			Z500 4007
Option: "Totaliser function for analogue signals"			Z500 4006
Further accessories:			
CS Basic – data evaluation graphically and in tabular form - reading of the measured data via USB or Ethernet, license for 2 workstations			0554 8040
CS Soft Energy Analyzer for energy and leakage analysis of compressed air stations			0554 7050
Connection cable for pressure, temperature and third-party sensors to mobile devices, ODU/open ends, 5 m			0553 0501
Connection cable for pressure, temperature and third-party sensors to mobile devices, ODU/open ends, 10 m			0553 0502
Connection cable for VA / FA sensors to mobile devices, ODU/M12, 5 m			0553 1503
Extension cable for mobile devices ODU/ODU, 10 m			0553 0504
Connection cable for mobile current / effective power meter to mobile devices, length 5 m			0553 0506
Case for all sensors (dimensions: 500 x 360 x 120 x mm)			0554 6006

Digital	Digital	Digital	Digital
m ³ /h, m ³	$^{\circ}\text{Ctd}$	A, kW/h	
			
Flow sensor	Dew point sensors	Current/effective power meter	Third-party sensors with RS 485

Digital	Analogue	Analogue	Analogue
Analogue	bar	A	$^{\circ}\text{C}$
			4...20 mA 0...20 mA 0...10 V Pulse Pt 100 Pt 1000
Pressure sensor	Clamp-on ammeter	Temperature sensor	Third party sensor analogue output

Matching sensors can be found on pages 38 to 41



PI 500 - Hand-held measuring device for the industry

The new **PI 500** is an all-purpose hand-held measuring device for many applications in the industry, like e. g.:

- **Flow measurement**
- **Pressure/vacuum measurement**
- **Temperature measurement**
- **Moisture/dew point measurement**

The graphic indication of colored measurement curves is inimitably.

Up to 100 million measured values can be stored with date and name of measuring site. The measured values can be transferred to the computer by means of a USB stick. The data can be conveniently evaluated with the CS Basic software.

Measured data and service reports can be issued easily and quickly. The following probes can optionally be connected to the freely configurable sensor input of PI 500:

- Pressure sensors (high and low pressure)
- Flow probes, VA 500/VA 520
- Temperature sensors Pt 100, Pt 1000/4...20 mA
- Dew point sensors FA 510
- Effective power meters
- Optional third-party sensors with the following signals: 0...1/10 V, 0/4...20 mA, Pt 100, Pt 1000, pulse, Modbus



Special features:

- Universal sensor input for many common sensor signals
- Internal rechargeable Li-Ion batteries (approx. 12 h continuous operation)
- 3.5" graphic display / easy operation via touch screen
- Integrated data logger for storage of the measured values
- USB interface for reading out via USB stick
- International: International: Up to 8 languages selectable

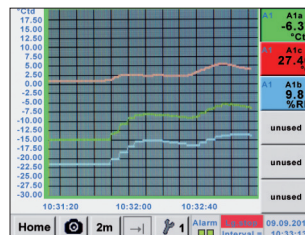

Measurement curves are displayed graphically, so the operator sees at a glance the behaviour of the dryer from the start of the measurement.



DewPoint	
-46.3	
°Ctd	
H1	H2
8.18 ppm	44.88 mg/m³
Hc	C1a
25.01 °C	6.540 bar

All physical parameters of the humidity measurement are calculated automatically. The PI 500 also displays the measured values of the external sensor.

Logger settings	
Time interval (sec)	
1	2
5	10
15	30
60	120
15	
<input checked="" type="checkbox"/> force new record file	
Comment: <input type="text" value="Dryer Trockener 13"/>	
<input type="checkbox"/> Logger stopped	
<input checked="" type="checkbox"/> timed Start	
<input checked="" type="checkbox"/> timed Stop	
START	STOP
12:26:00 - 06.0	13:28:00 - 06.0
Remaining logger capacity = 9999 days	
Logging: 0 channels selected	
time interval (min) 1 sec	
Back	

Up to 100 million measured values can be stored. Each measurement can be stored with a comment, e.g. measuring site name. The time interval can be freely set.

PI 500 - Hand-held measuring instrument with large sensor selection

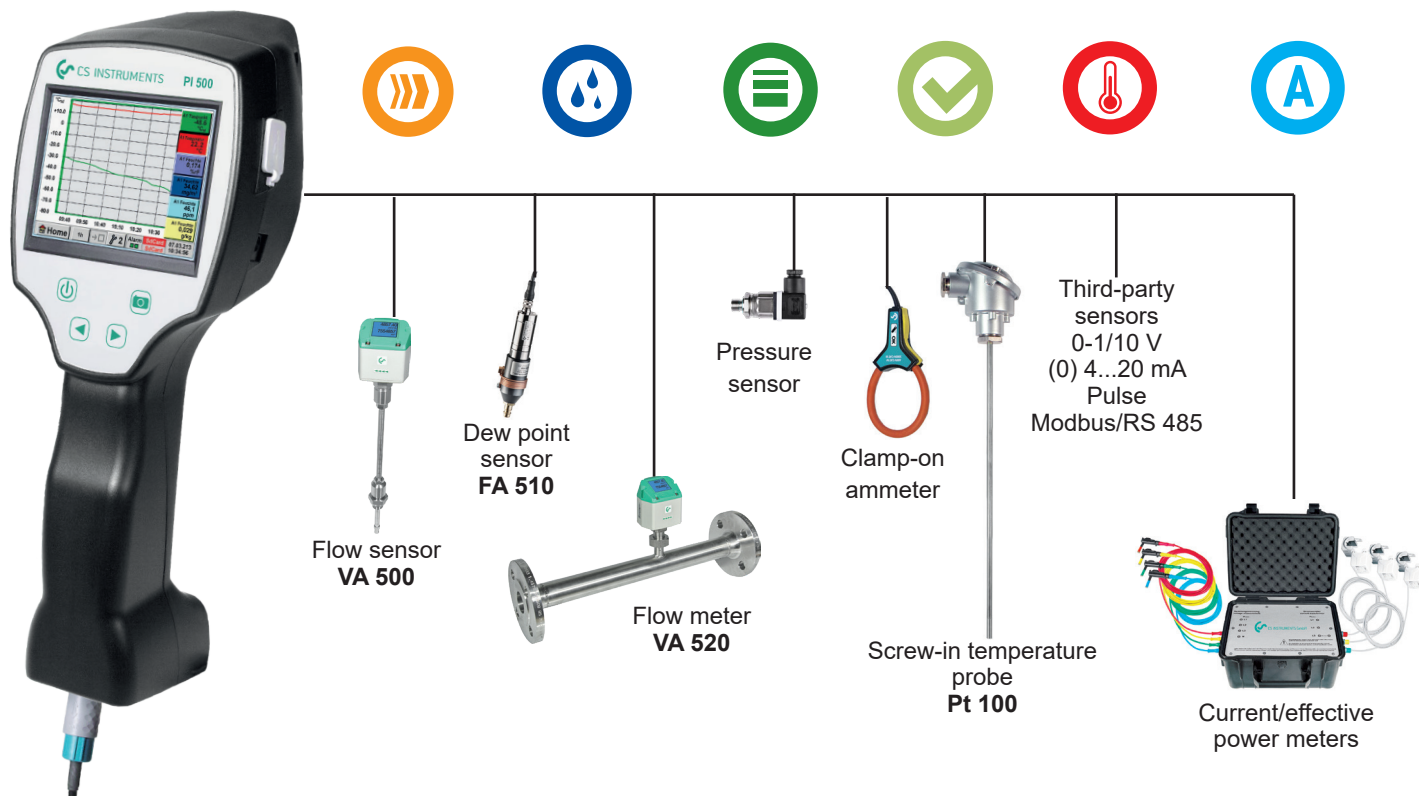

Flow sensor
VA 500

Dew point
sensor
FA 510

Flow meter
VA 520

Pressure
sensor

Clamp-on
ammeter

Screw-in temperature
probe
Pt 100

Third-party
sensors
0-1/10 V
(0) 4...20 mA
Pulse
Modbus/RS 485

Current/effective
power meters

INPUT SIGNALS

Current signals internal or external power supply

(0...20 mA/4...20 mA)

Measuring range
Resolution
Accuracy
Input resistance

0...20 mA
0.0001 mA
 $\pm 0.03 \text{ mA} \pm 0.05 \%$
50 Ω

Voltage signal:

(0...1 V)

Measuring range
Resolution
Accuracy
Input resistance

0...1 V
0.05 mV
 $\pm 0.2 \text{ mV} \pm 0.05 \%$
100 k Ω

Voltage signal

(0...10 V / 30 V)

Measuring range
Resolution
Accuracy
Input resistance

0...10 V
0.5 mV
 $\pm 2 \text{ mV} \pm 0.05 \%$
1 M Ω

RTD Pt 100

Measuring range
Resolution
Accuracy

-200...850 °C
0.1 °C
 $\pm 0.2 \text{ °C}$ (-100...400 °C)
 $\pm 0.3 \text{ °C}$ (further range)

RTD Pt 1000

Measuring range
Resolution
Accuracy

-200...850 °C
0.1 °C
 $\pm 0.2 \text{ °C}$ (-100...400 °C)

Pulse

Measuring range

Min pulse length 500 μ s
frequency 0...1 kHz
max. 30 VDC

DESCRIPTION

PI 500 portable measuring instrument with integrated data logger

Option: "Mathematics calculation function" for 4 freely selectable channels, (virtual channels): addition, subtraction, division, multiplication

Option: „Totaliser function for analogue signals“

CS Basic – data evaluation graphically and in tabular form - reading of the measured data via USB or Ethernet, license for 2 workstations

Transport case

ORDER NO.

0560 0511

Z500 5107

Z500 5106

0554 8040

0554 6510

Further sensors can be found on pages 38 to 41

TECHNICAL DATA PI 500

Display:

3.5" touch panel TFT transmissive, graphics, curves, statistics

Interfaces:

USB interface

Power supply for sensors:

Output voltage: 24 VDC $\pm 10\%$
Output current: 120 mA in continuous operation

Power supply:

Internal rechargeable Li-Ion batteries, charging time approx. 4 h,
PI 500 continuous operation > 4h depending on power consumption
for ext. sensor

Power adapter:

100 - 240 VAC / 50 - 60 Hz, 12 VDC - 1A, safety class 2 only for
use in dry rooms

Dimensions:

82 x 96 x 245 mm

Housing material:

PC/ABS

Weight:

450 g

Operating tempera- ture:

0...50 °C ambient temperature

Storage temperature:

-20 to +70 °C

EMC:

DIN EN 61326

Sensor input:

For connection of pressure and temperature sensors, clamp-on
ammeters, third-party sensors with 4 ... 20 mA, 0-10 V, Pt 100,
Pt 1000, Modbus

Memory Size:

16 GB memory card standard



Suitable sensors for DS 500 mobile, DS 400 mobile, PI 500, DP 510, LD 510

Flow meters for installation and removal under pressure (insertion type)



VA 500



VA 550

FLOW METERS INSERTION-VERSION

VA 500 flow meter, max. version (185 m/s), probe length 220 mm, incl. 5 m connection cable to mobile devices

VA 500 flow meter, high-speed version (224 m/s), probe length 220 mm, incl. 5 m connection cable to mobile devices

VA 550 Flow meter, measuring head in robust aluminium die casting housing

ORDER NO.

0695 1124

0695 1125

0695 0550
+ order code
A...M..._

Inline flow meter

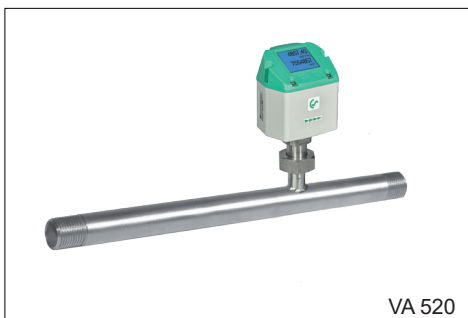

VA 520

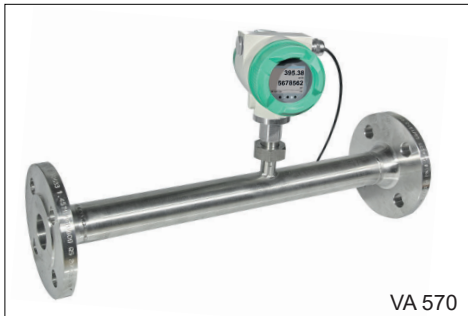

VA 570

FLOW METERS INLINE VERSION

Flow meter VA 520 with integrated measuring section, (R 1/4" DN 8)

Flow meter VA 520 with integrated measuring section, (R 1/2" DN 15)

Flow meter VA 520 with integrated measuring section, (R 3/4" DN 20)

Flow meter VA 520 with integrated measuring section, (R 1" DN 25)

Flow meter VA 520 with integrated measuring section, (R 1 1/4" DN 32)

Flow meter VA 520 with integrated measuring section, (R 1 1/2" DN 40)

Flow meter VA 520 with integrated measuring section, (R 2" DN 50)

Inline flow meter VA 570 with integrated 1/2" measuring section

Inline Flow meter VA 570 with integrated 3/4" measuring section

Inline Flow meter VA 570 with integrated 1" measuring section

Inline Flow meter VA 570 with integrated 1 1/4" measuring section

Inline flow meter VA 570 with integrated 1 1/2" measuring section

Inline Flow meter VA 570 with integrated 2" measuring section

ORDER NO.

0695 0520

0695 0521

0695 0522

0695 0523

0695 0526

0695 0524

0695 0525

0695 0570
+ order code
A...K_

0695 0571

0695 0572

0695 0573

0695 0574

0695 0575



FA 510

DEW POINT SENSORS

FA 510 dew point sensor, -80...+20 °Ctd incl. measuring chamber mobile and 5 m connection cable to mobile devices

FA 510 dew point sensor, -20...+50 °Ctd incl. measuring chamber mobile and 5 m connection cable to mobile devices

ORDER NO.

0699 1510

0699 1512

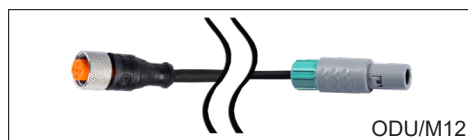

ODU/M12

CONNECTION CABLE FOR VA 500/520 AND FA 510 SENSORS

Connection cable for VA / FA sensors to mobile devices, ODU/M12, 5 m

Extension cable for mobile instruments, ODU / ODU, 10 m

ORDER NO.

0553 1503

0553 0504

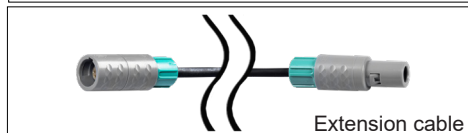

Extension cable



CALIBRATION CERTIFICATES FOR FLOW METERS AND DEW POINT SENSORS

5 point precision calibration for flow sensors incl. ISO certificate

Precision calibration at -40 °Ctd with ISO certificate

ORDER NO.

3200 0001

0699 3396



Suitable sensors for DS 500 mobile, DS 400 mobile, PI 500, DP 510, LD 510



PRESSURE PROBE WITH 4...20 mA ANALOGUE OUTPUT	± 1%	± 0,5%
	ACCURACY	ACCURACY
Standard pressure probe CS 16, 0...16 bar	0694 1886	0694 3555
Standard pressure probe CS 40, 0...40 bar	0694 0356	0694 3930
Standard pressure probe CS 1.6, 0...1.6 bar abs.		0694 3550
Standard pressure probe CS 10, 0...10 bar	0694 3556	0694 3554
Standard pressure probe CS 100, 0...100 bar		0694 3557
Standard pressure probe CS 250, 0...250 bar		0694 3558
Standard pressure probe CS 400, 0...400 bar		0694 3559
Precision pressure probe CS -1...+15 bar, ± 0.5 % accuracy of. f.s.		0694 3553
Differential pressure probe 1.6 bar diff.		0694 3561
Calibration certificate pressure, 5 calibration points for the whole measuring range	3200 0004	



DIGITAL PRESSURE SENSORS	± 1%	± 0,5%
	ACCURACY	ACCURACY
Digital pressure probe DPS 16, 0...16 bar RS 485, G1/2"	0694 2886	0694 4555
Digital pressure probe DPS 16, 0...16 bar RS 485, NPT 1/2"	0694 3886	0694 5555

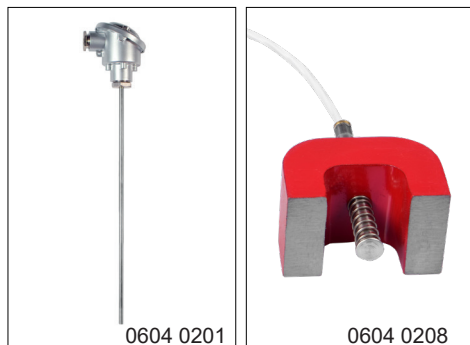

TEMPERATURE SENSORS	ORDER NO.
Bendable temperature sensor PT 100 (2-wire) class B, length: 300 mm, d=3 mm, -70...+550 °C, connection cable 2 m PFA with ODU plug (8-pin) to mobile devices	0604 0200
Screw-in temperature sensor PT 100 class A, length 300 mm, d = 6 mm, with measuring transducer 4...20 mA = -50 °C...+ 550 °C (2-wire)	0604 0201
Cross-band surface probe, thermocouple type K with measuring transducer 4...20 mA = 0°C...+180 °C, 2 m cable PVC with ODU plug (8-pole) to mobile devices	0604 0202
Cable temperature sensor PT 100 class A (4-wire), length: 300 mm, d = 6 mm, -70 ... +260 °C, 5 m connection cable PFA with open ends	0604 0205
Cable temperature sensor PT 100 class A (4-wire), length: 100 mm, d = 6 mm, -70...+260 °C, 5 m connection cable PFA with open ends	0604 0206
Cable temperature sensor PT 100 class A (4-wire), length: 200 mm, d = 6 mm, -70...+260 °C, 5 m connection cable PFA with open ends	0604 0207
Magnetic surface temperature sensor, holding magnet 39x26x25 mm, PT 100 class B (2-wire), -30...+180 °C, 5 m connection cable PFA with open ends	0604 0208
Compression fitting: 6 mm; G 1/2" PTFE clamping ring pressure-tight up to 10 bar. Material: stainless steel, application area: max. + 260 °C	0554 0200
Compression fitting: 6 mm; G 1/2" stainless steel clamping ring. Pressure-tight up to 16 bar, material: stainless steel, application area: max. + 260 °C	0554 0201
Calibration certificate temperature, 2 calibration points	0520 0180



0604 0205

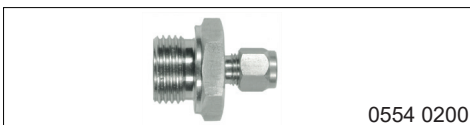

0554 0200

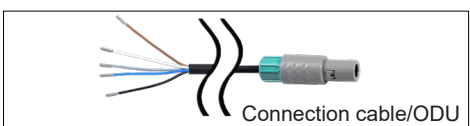

Connection cable/ODU

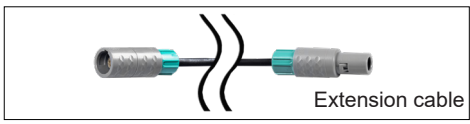

Extension cable



ODU connector

CONNECTION CABLES FOR PRESSURE SENSORS / TEMPERATURE SENSORS	ORDER NO.
Connection cable for pressure, temperature or third-party sensors on mobile devices, ODU/open ends, 5 m	0553 0501
Connection cable for pressure, temperature or third-party sensors on mobile devices, ODU/open ends, 10 m	0553 0502
Extension cable for mobile instruments, ODU / ODU, 10 m	0553 0504
ODU plug for connection to mobile devices	Z604 0104



Suitable sensors for DS 500 mobile, DS 400 mobile, PI 500, DP 510, LD 510

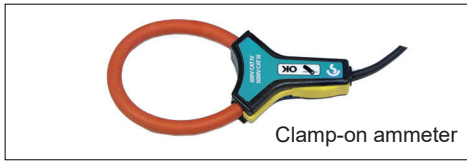

CLAMP-ON AMMETERS

- Clamp-on ammeter 0...1000 A TRMS incl. 3 m connection cable
- Clamp-on ammeter 0...400 A TRMS incl. 3 m connection cable

ORDER NO.

- 0554 0519
- 0554 0511

Suitable sensors for DS 500 mobil, DS 400 mobil, PI 500



CURRENT/EFFECTIVE POWER METER

- CS PM 600 mobile current/effective power meter up to 100 A**
- CS PM 600 mobile current/effective power meter up to 600 A**

ORDER NO.

- 0554 5341
- 0554 5342

- Mobile current/effective power meter with 3 external current transformers for big machines and systems
- External current transformers for encompassing the phases (100 A or 600 A)
- External magnetic measuring tip for picking off the voltage – measures kW, kWh, cos, phi, Var, kVA
- Data transfer to DS 500 mobile / DS 400 mobile via Modbus
- Incl. connection cable for mobile current/effective power meter, 5 m

Current transformer 100A/1A consisting of 3 transformers for mobile instruments

Z554 0001

Current transformer 600A/1A consisting of 3 transformers for mobile instruments

Z554 0002

Current transformer 1000A/1A consisting of 3 transformers for mobile instruments

Z554 0003

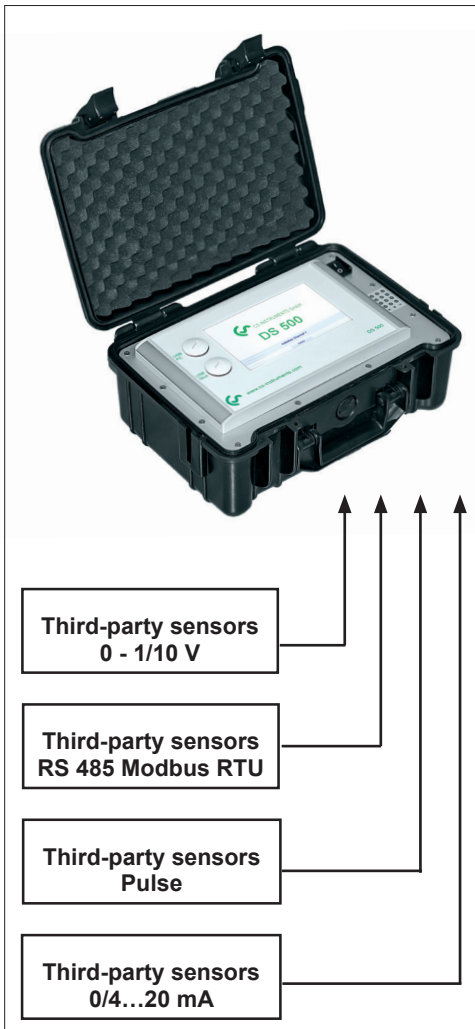

ANY THIRD-PARTY SENSOR CONNECTABLE

Additionally, any third-party sensors with the following signal outputs can be connected:

- 4-20 mA
- 0-20 mA
- 0-1 V/0-10 V/0-30 V
- Pt 100 (2- or 3-wire)
- Pt 1000 (2- or 3-wire)
- Pulse outputs (e. g. of gas meters)
- Frequency output
- Modbus protocol

CS PM 600 - Mobile current/effective power meter suitable for: DS 500 mobile / DS 400 mobile / PI 500

Measures voltage, current and calculates:

Effective power [kW]
 Apparent power [kVA]
 Reactive power [kVar]
 Active energy [kWh]
 cos phi



All measured data are transferred digitally (Modbus) to DS 500 mobile/ DS 400 mobile and can be recorded there.



Example: Measurement on the compressor

Magnetic voltage measuring tips electrically isolated

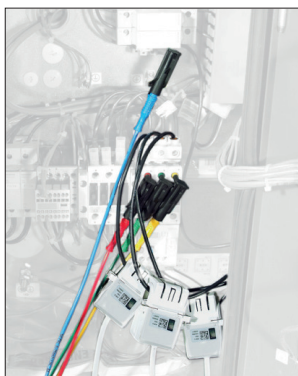

Special features:

- Magnetic voltage measuring tips for picking off the voltage during operation
- Hinged current transformers encompass the conductors of the phases L1, L2, L3. This can also be done during operation

TECHNICAL DATA CS PM 600

Parameters:	Voltage (Volt) Current (Ampere) Cos phi Effective power (kW) Apparent power (kVA) Reactive power (kVar) Active energy (kWh) Power frequency (Hz) All parameters are transferred digitally to DS 500 mobile /DS 400 mobile
Accuracy current measurement:	Threshold values for current deviation. Loss angle according to IEC 60044-1. Current deviation in % at rated current in 120% 1 100% 1 20% 1.5 5% 3
Accuracy active energy:	IEC 62053-21 Class 1
Sensor connections:	3 x current transformers (L1,L2,L3,N) 4 x voltage measurement (L1,L2,L3)
Interfaces:	RS 485 (Modbus protocol)
Measuring range:	Voltage measurement max. 400 Volt (in special version up to 480V) Current measurement max. 100 A or 600 A
Size current transformers:	100 A / 1 A (max. 24 mm wire), 600 A / 1 A (max. 36 mm wire)
Dimensions case:	270 x 225 x 156 mm (B x H x T)
Operating temperature:	- 10...+40 °C

DESCRIPTION	ORDER NO.
CS PM 600 mobile current/effective power meter 100 A	0554 5341
CS PM 600 mobile current/effective power meter 600 A	0554 5342
<ul style="list-style-type: none"> • Mobile current/effective power meter with 3 external current transformers for big machines and systems • External current transformers for encompassing the phases (100 A or 600 A) • External magnetic measuring tip for measuring the voltage • Measures kW, kWh, cos, phi, kVar, kVA • Data transfer via Modbus • Incl. connection cable for mobile current/effective power meter to mobile instruments, 5 m 	
Current transformer 100A/1A consisting of 3 transformers for mobile instruments	Z554 0001
Current transformer 600A/1A consisting of 3 transformers for mobile instruments	Z554 0002
Current transformer 1000A/1A consisting of 3 transformers for mobile instruments	Z554 0003



Energy analysis - consumption measurement - leakage calculation

DS 500 mobile - Energy analysis according to DIN EN 50001

If we talk about operating costs in compressed air systems, we are actually talking about the energy costs, because the electricity costs make up about 70-80% of the total cost of a compressed air system. Depending on the size of the system, this means considerable operating costs.

Even in smaller systems, this may quickly add up to €10,000 to 20,000 per year. This is an amount which can be considerably reduced – even in case of well operated and maintained plants. This will also apply to your compressed air system without a doubt!

Which are your actual costs per generated m³ air? Which energy is gained due to the waste heat recovery? What is the total performance balance of your plant?





What is the differential pressure of individual filters? What is the humidity (pressure dew point)? How much compressed air is consumed?

Although compressed air is one of the most expensive forms of energy, there are often enormous energy losses in factories, especially in this area.

They are mainly caused by the following factors:

- **Disuse of the waste heat**
- **Leakages of up to 50%**
- **Missing compressor control system**
- **Compressed air losses**

Lots of systems are not adapted to the actual demand or they are in need of repair. Leak curing programs could save about 1.7 million tons of carbon dioxide emissions per year. (Source: Fraunhofer Institut, Karlsruhe).

So there is a considerable amount of possible energy savings slumbering in the compressed air lines of lots of enterprises. To tap into this, the heat generated during compressed air generation should be used to heat the space or to heat water.

Furthermore, it is important to optimise the control of compressed air stations because this will lead to considerable energy savings in any case. Also the restoration of an ailing or no longer suitable compressed air supply will pay off after only a short period of time. Losses due to leakages within the pipe network incur high costs.

This table shows the annual energy costs incurred by leaks:

Hole diameter mm	Air loss at		Energy loss at		Cost at	
	6 bar (1/s)	12 bar (1/s)	6 bar (kWh)	12 bar (kWh)	6 bar (€)	12 bar (€)
1	1.2	1.8	0.3	1.0	144.00	480.00
3	11.1	20.8	3.1	12.7	1488.00	6096.00
5	30.9	58.5	8.3	33.7	3984.00	16176.00
10	123.8	235.2	33.0	132.0	15840.00	63360.00

(Source: compressed air efficiency, kW x €0.06 x 8000 working hours per year)

Energy resources like electricity, water and gas are usually monitored and therefore the costs are transparent.

Water consumption, for example, is precisely measured with consumption meters. Contrary to compressed air, a water leak is visible for all to see straight away and therefore fixed immediately. Leakages in the compressed air network „blow out“ unnoticed, even on weekends and during production stops.

The compressors continue to run during this time just to maintain a constant pressure in the network. For mature compressed air networks, the leak rate can be between 25 and 35 percent. They are the most industrious consumers working 365 days a year.

Not considered in these considerations are the costs of “producing clean and dry” compressed air. Refrigeration and adsorption dryers dry the air with significant operating costs, which then “blows out” uselessly.

With ever-increasing energy costs, these potential savings must be used more and more to stay competitive within the market. Savings potential can only be exploited if the consumption of individual machines or systems is known and made transparent for all.

When introducing an energy management system according to DIN EN 16001, all consumers have to be recorded in the first step. This gives the user an overview of what is being consumed. This transparency makes it possible to deliberately intervene and save energy. In compressed air systems this means, in the first step, to detect and eliminate leaks.

Especially for the complete monitoring and consumption analysis of compressor stations and compressed air lines we developed a portable measuring system, the DS 500 mobile. DS 500 mobile meets with all requirements for analyzing a compressed air system.

In addition to the evaluation of standard sensors such as for example:

- **Flow meters,**
- **Pressure dew point,**
- **Pressure,**
- **Differential pressure,**
- **Absolute pressure,**
- **Temperature sensors**

, the connection of all kinds of third-party sensors such as:

- **Pt 100**
- **Pt 1000**
- **0/4...20 mA**
- **0-1/10 V**
- **pulse**
- **RS 485 Modbus etc.**

is also possible. One of the main advantages of DS 500 mobile is the possibility to connect not only clamp-on ammeters but also external power meters, water meters or heat meters. As such, the current costs can be included very accurately in the analysis and typical figures of a compressed air plant can be determined.



DS 500 mobile enables an intelligent energy analysis in a quick and easy way. The data will be indicated immediately in the display.

For this purpose just the costs in € per kWh (please consider day and night tariff) have to be entered.

By means of a mathematical function typical calculations can be carried out like for example:

- **Costs in € per generated m³ of compressed air**
- **Specific output in kWh/m³**
- **Consumption of single compressed air lines including summation**
- **Indication of Min-Max values, average value**

If the minimum values rise continuously over the years this is a clear signal that the leakage rate increases. This can easily be determined by carrying out the measurements in regular intervals.

Consumption analysis including statistics at the touch of a button

Besides the compressed air also all other energy costs like current, water, vapor etc. can be recorded in this evaluation. This creates transparency.

So all energy and flow meters for compressed air, gas, water, vapor and so on can be recorded and evaluated. The customer gets the costs in €uro.

On the big 7" colour display with touch panel, all information is visible at a glance. By means of the evaluation software CS Soft Basic all data can be evaluated online at the PC via a USB stick or Ethernet.

Additionally to the consumption analysis as daily/weekly or monthly report an alarm can be sent by e-mail or SMS in case of threshold value exceedance.

The measured data can be retrieved all over the world via the webserver, GSM module.

How is this done in practice?

Step 1: Measurement

It is a special advantage that up to 12 compressors can be measured with one DS 500 mobile at the same time.

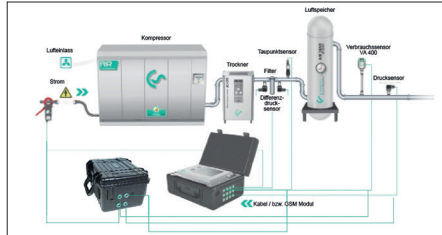

Step 2: Analysis

2.1) Compressor analysis (current-/ power measurement)

The energy consumption of every single compressor is measured by means of a clamp-on ammeter. The produced compressed air quantity is calculated by the software on a basis of the performance data of the compressor which have to be entered.

- **The following parameters are calculated additionally:**
- **Energy consumption in (kWh),**
- **Load,**
- **Idle,**
- **Stop time,**
- **Compressor load in %,**
- **Number of load/unload cycles, specific output in kWh/m³,**
- **Costs in €/m³**

2.2) System analysis (current measurement and real consumption measurement)

The system analysis has the same function like the compressor analysis, however, it additionally offers the possibility to measure the actually produced resp. used quantity of compressed air by means of the flow sensor VA 500.

With the additional „real consumption measurement“ the leakages and therefore the cost share of the leakages in comparison to the total costs in € can be determined.

2.3) Leakage calculation

The leakage calculation is carried out during production-free time (shutdown, weekend, holidays). The flow meter VA 500 measures the actual supplied quantity. The compressor delivers compressed air during this down time, in order to maintain a constant pressure.

According to statistics, even if production is carried out day and night, there is at least one short period of time during which all load is switched off. By means of this data, the software defines a calculated leakage rate and calculates the incurred leakage costs in €.

Step 3: Evaluation at the PC with graphics and statistics

3.1) Entry of necessary parameters

Specific data have to be entered before the analysis is carried out:

- **Selection of compressor type (load/ idle resp. variable speed drive controlled)**
- **As well as entry of the performance data according to data sheet**
- **Period of measurement**
- **Costs in € for 1 kWh**

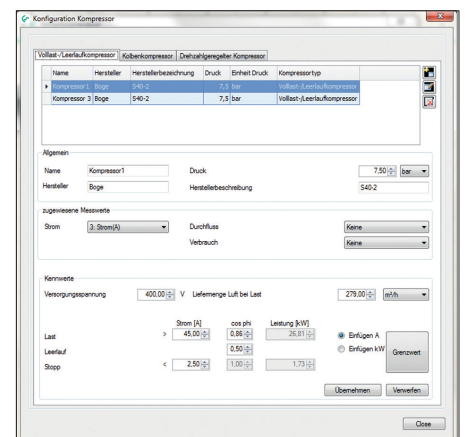



3.2) Graphic evaluation with day view and week view

Everything at a glance:

The user gets a day and week view of all stored measured data with his company logo (can be easily integrated) at the touch of a button. By means of the zoom and the cross lines function peak values can be determined.

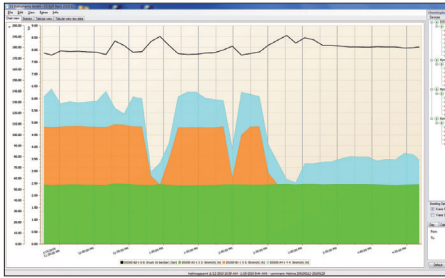

3.3) Compressed air costs in €

At the touch of a button the user gets all important data like e. g.:

- Electricity costs
- Compressed air costs
- Leakage costs in €
- Compressor data with load/ idle times
- Specific output in kWh/m³
- Costs per m³ in €

Energie- und Kostenauswertung																			
Zeitspanne: 12.01.2010 10:39 - 19.01.2010 09:44																			
Zeitspanne in Stunden: 167,4																			
Durchfluss Gesamt: Summe ausgewählter Kompressoren																			
Leckagegrenzwert: 128,00																			
Kompressor	Anlaufzeit (s)			Schaltzeitpunkt			Energie			Druckluft			Kosten (Euro)			Leckage			
	Start	Ende	Wartezeit	Start	Ende	Wartezeit	Leistung (kW)	Energie (kWh)	Druck (bar)	Volumen (m³)	Leistung (kW)	Energie (kWh)	Leistung (kW)	Energie (kWh)	Leistung (kW)	Energie (kWh)	Leistung (kW)	Energie (kWh)	
01 Kompressor	10:39	11:00	21	10	10:39	11:00	15,00	15,00	10,00	10,00	10,00	10,00	10,00	10,00	10,00	10,00	10,00	10,00	10,00
02 Kompressor	11:00	11:30	30	10	11:00	11:30	15,00	15,00	10,00	10,00	10,00	10,00	10,00	10,00	10,00	10,00	10,00	10,00	10,00
03 Kompressor	11:30	12:00	30	10	11:30	12:00	15,00	15,00	10,00	10,00	10,00	10,00	10,00	10,00	10,00	10,00	10,00	10,00	10,00
Gesamt	10:39	12:00	90	10	10:39	12:00	45,00	45,00	30,00	30,00	30,00	30,00	30,00	30,00	30,00	30,00	30,00	30,00	30,00

4) Measures

Based on these analysis some measures should be carried out in order to optimize the compressed air system. These measures may differ from system to system, however, normally there are the following possibilities:

- **Please check whether there are leakages in the compressed air system and localize them. Usually they occur at weld seams and junctions. (50 holes with a diameter smaller than 1 mm may cause incur of € 11,000 per year).**
- **By means of the load/idle analysis and the pressure profile the compressor regulation and adjustment should be optimized. Modern compressor operation systems help to minimize the idle times. (During idle times, the compressor takes up about 30 % of the full load energy, however, it does not release any air)**
- **Reduce the input temperature (a temperature reduction by about 10 °C can save 3% of the energy).**
- **Optimize the pipe system by avoiding unnecessary pressure drops.**



DP 500/510 - Mobile dew point meters with data logger

Applications:

- Compressed air: Examination of refrigeration, membrane, adsorption dryers
- Technical gases: Residual moisture measurement in gases such as N₂, O₂ etc.
- Plastics industry: Examination of granulate dryers

Special features:

- Precise dew point measurement down to -80 °Ctd
- Quick response time
- 3.5" graphic display / easy operation via touch screen
- Integrated data logger for storage of the measured values
- USB interface for reading out via USB stick
- Calculates all necessary moisture parameters like g/m³, mg/m³, ppm V/V, g/kg, °Ctdatm
- 2nd freely assignable sensor input for third-party sensors (only DP 510)
- International: up to 8 languages selectable



Quick installation by means of measuring chamber and quick coupling



Ideal for service technicians - everything in one case



Dry container - for sensor protection and quick adaption time

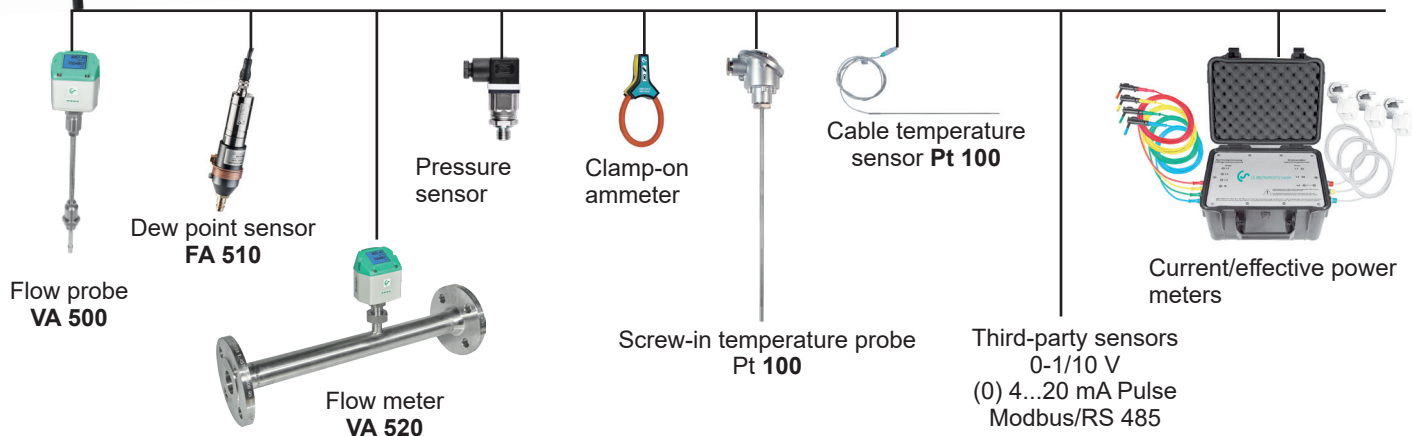

The whole range of suitable sensors can be found on pages 38 to 41

Everything at a glance

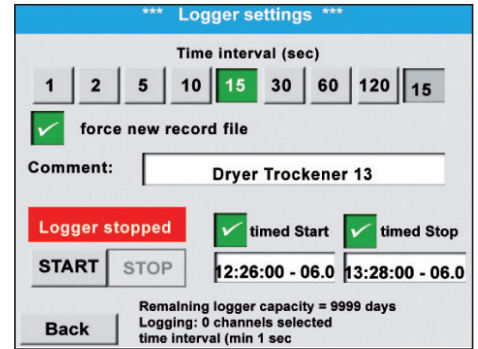
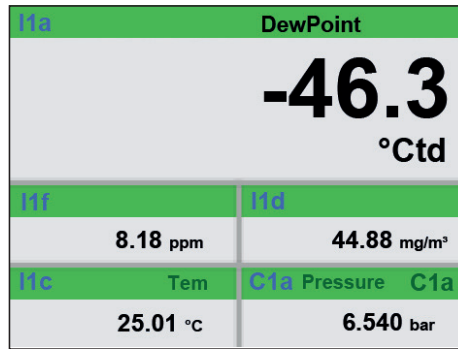
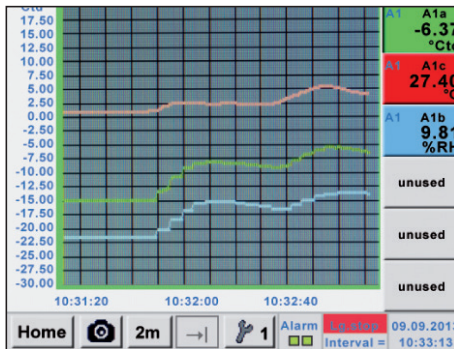

measurement curves are displayed graphically, so the operator sees at a glance the behavior of the dryer since the start of the measurement.

All physical parameters of the humidity measurement are calculated automatically. The DP 510 also displays the measured values of the external sensor.

Up to 100 million measured values can be stored. Each measurement can be stored with a comment, e.g. measuring site name. The time interval can be freely set.

DESCRIPTION	ORDER NO.
Set DP 500 in a case - consisting of:	0600 0500
- Portable dew point meter DP 500 for compressed air and gases	0560 0500
- Mobile measuring chamber up to 16 bar	0699 4490
- Diffusion-tight PTFE hose with quick coupling, length 1 m	0554 0003
- Power supply for DP 500/DP 510	0554 0009
- Control and calibration set 11.3% RH	0554 0002
- Quick-lock coupling	0530 1101
- Dry container for CS dew point sensors	0699 2500
- Transportation case (small) for DP 500	0554 6500
Set DP 510 in a case - consisting of:	0600 0510
- Mobile dew point meter DP 510 with one additional input for external sensors	0560 0510
- Mobile measuring chamber up to 16 bar	0699 4490
- Diffusion-tight PTFE hose with quick coupling, length 1 m	0554 0003
- Power supply for DP 500/DP 510	0554 0009
- Control and calibration set 11.3% RH	0554 0002
- Quick-lock coupling	0530 1101
- Dry container for CS dew point sensors	0699 2500
- Transportation case (large) for DP 510 as well as other sensors	0554 6510
Further options, not included in the set:	
Option: „Mathematics calculation function“ for 4 freely selectable channels, (virtual channels): addition, subtraction, division, multiplication	Z500 5107
Option: „Totaliser function for analogue signals“	Z500 5106
CS Basic – data evaluation graphically and in table form - reading of the measured data via USB or Ethernet, licence for 2 workstations	0554 8040
Precision calibration at -40 °Ctd or 3 °Ctd with ISO certificate	0699 3396
Additional calibration point freely selectable in the range between -80...+20 °Ctd	0700 7710
High pressure measuring chamber up to 350 bar	0699 3590
Measuring chamber for atmospheric dew point	0699 3690
Measuring chamber for granulate dryers with minimum overpressure	0699 3490
Portable dew point meter DP 510 for compressed air and gases (high pressure version up to 350 bar)	0560 0512
Portable dew point meter DP 500 for compressed air and gases (high pressure version up to 350 bar)	0560 0501



Photo key saves current screen as an image file. No additional software necessary.

TECHNICAL DATA DP 500/510	
Display:	3.5" touch screen
Measuring range:	-80...+50 °Ctd -20...+70 °C 0...100% RH
Accuracy:	± 0.5 °Ctd at -10...+50 °Ctd Typ. ± 2 °Ctd (further range)
Moisture parameters:	g/m ³ , mg/m ³ , ppm V/V, g/kg, °Ctdatm, % RH
Pressure range:	-1...50 bar standard -1...350 bar special version
Interface:	USB interface
Data logger:	16 GB SD memory card (100 million values)
Power supply:	Output voltage: 24 VDC ± 10% Output current: 120 mA in continuous operation
Power supply:	Internal rechargeable Li-Ion batteries, approx. 12 h continuous operation, 4 h charging time
Screw-in thread:	G 1/2" stainless steel
Ambient temperature:	0...+50 °C
EMC:	DIN EN 61326-1



DP 400 mobile - With integrated dew point and pressure measurement

For measurement of all humidity parameters under pressure up to 16 bar

The DP 400 mobile with integrated, rechargeable battery has been developed especially for field use. In addition to a highly precise dew point sensor, a precise pressure sensor is also installed in the device up to 16 bar. So in addition to the pressure dew point in °Ctd, the temperature in °C and the line pressure in bar, further moisture parameters (% RH, mg/m³, g/m³) as well as pressure-dependent measured values (g/kg, ppm v/v, atm. dew point °C) can also be calculated.

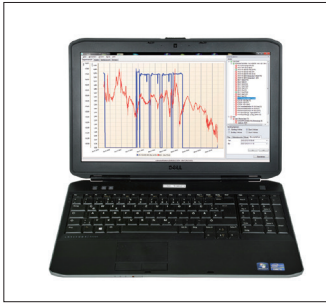

SPECIAL FEATURES:

- Precise dew point measurement down to -80 °Ctd, ppm V/V, atmospheric dew point
- Robust service case for field use
- Integrated pressure measurement up to 16 bar
- Integrated measuring chamber with integrated dry container protects the dew point sensor during transport and guarantees quick adaption time
- Humidity sensor with long-term stability: precise, condensation-resistant, quick adaption time
- Optional: 2 further sensor inputs for external sensors
- Optional: Integrated data logger



6 mm plug connection for measuring gas/compressed air feed

Option: Two further sensor inputs for: (flow, pressure, dew point, 4...20 mA, Modbus-RTU...)

Easy operation via touchscreen

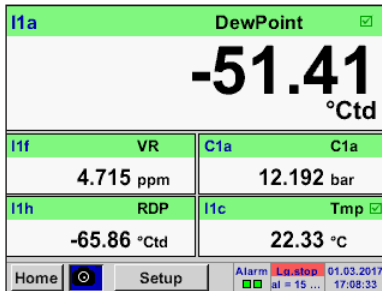

Actual measured values

All measured values can be seen at a glance. Threshold value exceedances are indicated in red color. Thanks to the integrated pressure sensor, DP 400 mobile is able to calculate the atmospheric dew point.

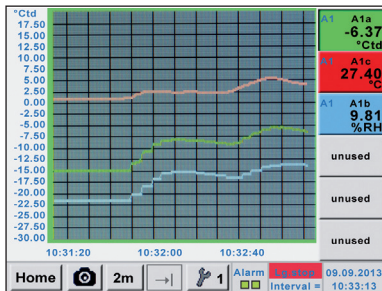

Graphic view

In the graphic view all measured values are indicated as curves. It is possible to browse back on the time axis by a slide of the finger (without data logger maximum 24 h, with data logger back to the start of the measurement).



Data logger

Measured values are stored in DP 400 by means of the option „integrated data logger“. The time interval can be freely set. Furthermore there is the possibility to fix the starting time and the end time of the data recording. Read-out of the measured data via USB interface or via the optional Ethernet interface.

DESCRIPTION	ORDER NO.	TECHNICAL DATA DP 400 MOBIL
DP 400 mobile - Portable dew point meter with integrated pressure measurement, incl. transportation bag for PTFE hose and power supply	0500 4505	Display: 3.5" touch screen Measuring range: -80...+50 °Ctd -20...+70 °C 0...100% RH 0...16 bar ± 0.5 % Accuracy: ± 1 °C at 50...-20 °Ctd ± 2 °C at -20...-50 °Ctd ± 3 °C at -50...-80 °Ctd Moisture parameters: g/m ³ , mg/m ³ , ppm V/V, g/kg, °Ctdatm, % RH Interface: USB interface Data logger option: 16 GB SD memory card (100 million values) Power supply for external sensors: Output voltage: 24 VDC ± 10% Output current: 120 mA in continuous operation Power supply: Internal rechargeable Li-Ion batteries, approx. 12 h continuous operation, 4 h charging time Process connection: 6 mm plug connections Ambient temperature: 0...+50 °C EMC: DIN EN 61326-1
Option: Integrated data logger for 100 million measured values	Z500 4002	
Option: Integrated Ethernet and RS 485 interface	Z500 4004	
Option: Integrated webserver	Z500 4005	
Option: "Mathematics calculation function" for 4 freely selectable channels, (virtual channels): addition, subtraction, division, multiplication	Z500 4007	
Option: 2 additional sensor inputs for external sensors (1 x digital sensor Modbus, 1 x analogue sensor)	Z500 4001	
CS Basic – data evaluation graphically and in tabular form - reading of the measured data via USB or Ethernet, license for 2 workstations	0554 8040	
Connection cable for VA / FA sensors to mobile devices, ODU/M12, 5 m	0553 1503	
Connection cable for pressure, temperature or third-party sensors on mobile devices, ODU/open ends, 5 m	0553 0501	
Connection cable for pressure, temperature or third-party sensors on mobile devices, ODU/open ends, 10 m	0553 0502	
Extension cable for mobile instruments ODU/ODU, 10m	0553 0504	

The whole range of suitable sensors can be found on pages 38 to 41



FA 510/515 - Dew point sensor

FA 510/515 for residual moisture measurement in compressed air and gases



Typical applications:

- Dew point measurement in the compressed air after adsorption dryer, membrane dryer, refrigeration dryer
- Residual moisture/dew point measurement in gases such as oxygen, nitrogen, argon...
- Residual moisture/dew point measurement after granulate dryers in the plastics industry

Recommendation:

Mounting with standard measuring chamber for compressed air up to 16 bar

Advantage: Easy installation via quick coupling

Special features:

- Extremely stable in the long term
- Analog output 4...20 mA for dew point
- Condensation-resistant
- Quick adaption time
- Pressure-tight up to 350 bar (special version)
- **NEW:** Modbus-RTU interface
- **NEW:** Higher resolution of sensor signal due to the improved evaluation electronics
- **NEW:** Sensor diagnosis on site with a portable device or CS Service Software
- **Readable via Modbus:**
 - Pressure dew point [°Ctd.]
 - Temperature [°C]
 - rel. humidity [% RH]
 - abs. humidity [g/m³]
 - Degree of humidity [g/kg]
 - Moisture content V/V [ppmV/V]
 - Partial vapor pressure [hPa]
 - Atmospheric dew point [°Ctd.atm]

DESCRIPTION	ORDER NO.
FA 510 dew point sensor for adsorption dryers -80...20 °Ctd incl. factory certificate, 4...20 mA analogue output (3-wire connection) and Modbus-RTU interface	0699 0510
FA 515 dew point sensor for adsorption dryers -80...20 °Ctd incl. factory certificate, 4...20 mA analogue output (2-wire connection) or Modbus-RTU interface	0699 0515
FA 510 dew point sensor for refrigeration dryer -20...50 °Ctd incl. factory certificate, 4...20 mA analogue output (3-wire connection) and Modbus-RTU interface	0699 0512
FA 515 dew point sensor for refrigeration dryer -20...50 °Ctd incl. factory certificate, 4...20 mA analogue output (2-wire connection) or Modbus-RTU interface	0699 0517
Connection cables:	
Connection cable for VA/FA series, 5 m	0553 0104
Connection cable for VA/FA sensors, 10 m	0553 0105
Option for FA 510:	
Option: analogue output FA 510, special version 2...10 volts	Z699 0510
Options for FA 510/515:	
Option: max. pressure FA5xx 350 bar	Z699 0515
Option: max. pressure FA5xx 500 bar	Z699 0516
Option: special scaling FA5xx 4...20 mA=___ ... ___ g/m ³ , ppm etc.	Z699 0514
Option: connection thread FA5xx, 5/8" UNF	Z699 0511
Option: surface condition FA 5xx, free of oil & grease	Z699 0517
Further accessories:	
Standard measuring chamber up to 16 bar	0699 3390
High pressure measuring chamber up to 350 bar	0699 3590
Stainless steel bypass measuring chamber for dew point measurement in gases under pressure	0699 3290
CS Service Software for dew point sensors incl. PC connection set (Modbus to USB Interface).	0554 2007
Calibration and adjustment:	
Precision calibration at -40 °Ctd or 3 °Ctd incl. ISO certificate	0699 3396
Additional calibration point freely selectable	0700 7710

TECHNICAL DATA FA 510/515

Measuring range:	-80...20 °Ctd, -20...50 °Ctd
Accuracy:	± 1 °C at 50...-20 °Ctd ± 2 °C at -20...-50 °Ctd ± 3 °C at -50...-80 °Ctd
Pressure range:	-1...50 bar Special version up to 500 bar
Power supply:	24 VDC (10...36 VDC)
Protection class:	IP 66
EMC:	In acc. with DIN EN 61326-1
Operating temperature:	-20...70 °C
Connection:	M12, 5-pin
PC connection:	Modbus-RTU interface (RS 485)
Analogue output:	4...20 mA = -80...20 °Ctd 4...20 mA = -20...50 °Ctd FA 510: 4...20 mA (3-wire) FA 515: 4...20 mA (2-wire)
Burden for analogue output:	< 500 Ω
Screw-in thread:	G 1/2" Stainless steel Optional: UNF 5/8", NPT 1/2"
Dimensions:	Ø 30 mm, length approx. 130 mm
Via service software:	
Choose units	% RH, °Ctd, g/m ³ , mg/m ³ , ppm V/V
Scaling	4...20 mA change

DS 52 - Dew point monitoring

The dew point set is wired ready to plug in at the factory. The alarm values can be set freely. The dew point sensor FA 510 is extremely long-term stable and can be quickly and easily installed and removed under pressure via the screw-on measuring chamber incl. Quick coupling.

Option:
Alarm unit (Buzzer and continuous red light)

Consisting of:
Digital process meter DS 52

Special features:

- Plug-in system: everything wired and ready
- No time-consuming studying of the instruction manual
- 2 alarm contacts (250 VAC, 3 A) pre- and main alarm freely adjustable
- 4...20 mA analogue output
- Option alarm unit: Buzzer and continuous red light



DESCRIPTION	ORDER NO.	TECHNICAL DATA DISPLAY DS 52
Dew point monitoring DS 52 for adsorption dryer consisting of:	0600 5100	<p>Dimensions: 118 x 92 x 93 mm</p> <p>Display: LED red, 7-segment, height: 13 mm, 5-digit, 2 LED for alarm relay</p> <p>Keypad: 4 keys</p> <p>Input: 4...20 mA</p> <p>Power supply: 230 VAC, 50/60 Hz; option: 24 VDC or 110 VAC 50/60 Hz</p> <p>Alarm outputs: 2 x relay output, changeover contact, 250 VAC, max. 3 A</p> <p>Operating temperature: -10...+60 °C (storage temperature -20 °C...+80 °C)</p> <p>Alarm thresholds: Freely adjustable</p> <p>Hysteresis: 2 °Ctd</p> <p>Analogue output: 4...20 mA = -80...20 Ctd or -20...50 Ctd.</p>
DS 52 LED process display in the wall housing	0500 0009	
FA 510 dew point sensor for adsorption dryers -80 °...20 °Ctd incl. factory certificate, 4...20 mA analogue output (3-wire connection) and Modbus-RTU interface	0699 0510	
Standard measuring chamber up to 16 bar	0699 3390	
Connection cable for VA/FA series, 5 m	0553 0104	
Dew point monitoring DS 52 for refrigeration dryers, consisting of:	0600 5120	
DS 52 LED process display in the wall housing	0500 0009	
FA 510 dew point sensor for refrigeration dryer -20...50 °Ctd incl. factory certificate, 4...20 mA analogue output (3-wire connection) and Modbus-RTU interface	0699 0512	
Standard measuring chamber up to 16 bar	0699 3390	
Connection cable for VA/FA series, 5 m	0553 0104	
Options:		
Power supply 24 VDC (instead of 230 VAC)	Z500 0001	
Power supply 110 VAC (instead of 230 VAC)	Z500 0002	
Alarm unit mounted to the wall housing	Z500 0003	
Alarm unit for external mounting with 5 m cable	Z500 0004	
Further accessories:		
Precision calibration at -40 °Ctd incl. ISO certificate	0699 3396	
Additional calibration point freely selectable	0700 7710	



FA 515 Ex Dew point sensor - For residual moisture measurement in potentially explosive atmospheres

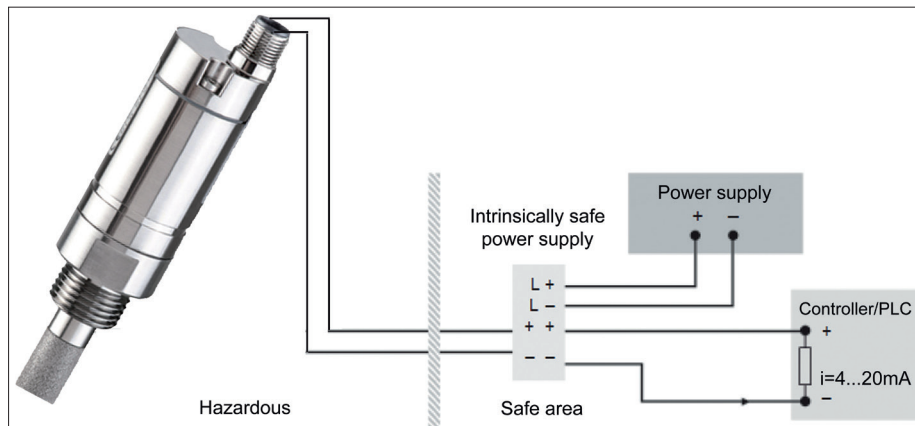

The FA 515 Ex measures dew point or pressure dew point in potentially explosive atmospheres and can be used in many nonaggressive gases.

Typical applications:

- Air/Compressed air
- Argon
- Nitrogen
- Biogas
- Natural gas
- Hydrogen
- etc...

Special features:

- Robust design
- Pressure-tight up to 500 bar
- Humidity sensor with long-term stability, tried-and-tested for years
- 4...20 mA analogue output in 2-wire technology
- **NEW:** Higher resolution of sensor signal due to the improved evaluation electronics

Approvals:

- II 2 G Ex ib IIC T4 Gb Zone 1, gas, intrinsically safe, temp. 135 °C
- II 2 D Ex ib IIIC T80°C Db Zone 21, dust, intrinsically safe, temp. 80 °C

FA 515 Ex may only be used in connection with approved Ex-rated power supplies or safety barriers or galvanic separating elements with max.:

- $U_i = 28 \text{ V max.}$
- $I_i = 95 \text{ mA max.}$
- $P_i = 0.65 \text{ W max.}$

TECHNICAL DATA FA 515 EX

Measuring range:	-80...+20 °Ctd = 4...20 mA
Pressure range:	-1...500 bar
Power supply:	24 VDC (18...28 VDC)
Accuracy:	± 1 °C at -20...+20 °Ctd ± 2 °C at -50...-20 °Ctd ± 3 °C at -80...-50 °Ctd
Output:	4...20 mA in 2-wire technology
Protection class:	IP 65
EMC:	In acc. with DIN EN 61326-1
Operating temperature:	-20...+70 °C
Storage temperature:	-40...+80 °C
Burden for analogue output:	< 500 Ω at 24 V
Screw-in thread:	G 1/2" stainless steel optional 5/8" UNF
Connection:	M12, 4-pin
Sensor protection:	Sinter filter 50 μm stainless steel

DESCRIPTION	ORDER NO.
FA 515 Ex pressure dew point meter	0699 5515
High pressure measuring chamber for compressed air up to 350 bar	0699 3590
Stainless steel bypass measuring chamber for dew point measurement in gases under pressure	0699 3290
Special scaling, analogue output to other humidity parameters: % RH, g/m ³ , mg/m ³ , ppm V/V, g/kg	Z699 0514
Connection cable FA 515 EX, for laying in intrinsically safe circuits, ends open on both sides (cross-section 4x0.75 mm ²), cable length of free choice	0553 5126
Shielded connection cable FA 515 EX, for laying in intrinsically safe circuits, ends open on both sides (cross-section 4x0.75 mm ²), cable length of free choice	0553 5136
Intrinsically safe power supply, safety barrier	0554 3071

Notes

Lined area for taking notes, consisting of 23 horizontal lines.



FA 550 dew point sensor - In robust die-cast aluminium housing

The FA 550 is ideal for outdoor dew point measurements or rougher industrial environment



Special features:

- Robust, waterproof die-cast aluminium housing, IP 67
- Alarm relay - limit value adjustable via buttons (max 60 VDC, 0.5 A)
- 4...20 mA analogue output
- Optional: 2 pieces 4 ... 20 mA analogue output e.g. for dew point and temperature
- Extremely stable in the long term
- Quick adaption time
- Pressure-resistant up to 500 bar (optional)
- **NEW:** Modbus-RTU interface
- **NEW:** Ethernet interface (optional)
- **NEW:** Higher resolution of sensor signal due to the improved evaluation electronics
- **NEW:** Sensor diagnosis on site with a portable device or CS Service Software
- **Readable via Modbus:** pressure dew point [° Ctd.], temperature [° C], rel. humidity [% RH], abs. humidity [g/m³], degree of humidity [g/kg], moisture content V/V [ppmV/V], partial vapour pressure [hPa], atmospheric dew point [° Ctd.atm]

APPLICATION:

- Dew point measurement in the compressed air after adsorption dryers/membrane dryers and refrigeration dryers
- Residual moisture measurement / dew point measurement in gases such as: oxygen, nitrogen, argon, hydrogen, natural gas, biogas ...

Easy operation via the keys on the display

The screenshots show the following data and settings:

- Screen 1 (1/3):** Main display showing **-47.8 °Ctd**.
- Screen 2 (2/3):** Temperature: 22.10 °C, Relative Humidity: 0.1940 %rH, Absolute Humidity: 0.0378 g/m³.
- Screen 3 (3/3):** Degree of Humidity: 0.0321 g/kg, Moisture Content: 50.88 ppm, Partial Vapour Pressure: 0.0522 hPa, Atmospheric Dew Point: -47.80 °Ctd.
- Screen 4 (Alarm):** Alarm status: Alarm. Unit: °Ctd, Value: -60.00, Hysteresis: 2.00. Buttons: overrun, back.
- Screen 5 (4 - 20mA Channel 1):** State: on, Unit: °Ctd. Scale 4mA: -80.00°Ctd, Scale 20mA: 20.00°Ctd. Button: back.
- Screen 6 (4 - 20mA Channel 1):** State: on, Unit: g/m³. Scale 4mA: 0g/m³, Scale 20mA: 10g/m³. Buttons: Save, Cancel.
- Screen 7 (IP Adresse Einstellen):** DHCP: . IP Address: 192.168.172.010, Sub Netz: 255.255.255.000, Gateway: 192.168.172.001. Buttons: Erweitert, Speicher, Abbruch.
- Screen 8 (Pressure Setting):** Ref. Pressure: 1013.00 hpa, Sys. Pressure: 7500.00 hpa. Button: back.

The integrated display shows the dew point in big figures as well as further humidity parameters on two more display pages. The arrow key can be used to scroll between the display pages.

The alarm threshold value for the integrated relay can be freely entered via the keys. In addition to the alarm threshold, the hysteresis can also be freely entered.

The 4...20 mA analogue output can be scaled freely or also allocated to one further parameter, e. g. g/m³.

After entering the system pressure of the compressed air system and the reference pressure (atmospheric pressure), the sensor can also calculate back to the atmospheric dew point from the measured pressure dew point if desired.

Example order code FA 550: [0699 0550_A1_B1_C1_D1_E1_F1_G1_H1_I1](#)

Measuring range	
A1	-80...+20 °Ctd. (-112 to 68 °F)
A2	-20...+50 °Ctd. (-4 to 122 °F)
A3	-40...+30 °Ctd. (-40 to 86 °F)
A4	-60...+30 °Ctd. (-76 to 86 °F)
A5	-80...+20 °Ctd. (-112 to 68 °F) (scaling 4...20 mA = -100...+20 °Ctd.)
A6	-80...+20 °Ctd. (-112 to 68 °F) (scaling 4...20 mA = -110...+20 °Ctd.)

Display option	
B1	with integrated display
B2	without display

Option Signal output / Bus connection	
C1	2 x 4 ... 20 mA analogue output (electrically isolated), alarm relay, RS 485 (Modbus-RTU)
C4	1 x 4 ... 20 mA analogue output (not electrically isolated), alarm relay, RS 485 (Modbus-RTU)
C5	Ethernet interface (Modbus / TCP), 1 x 4 ... 20 mA analogue output (not electrically isolated), alarm relay, RS 485 (Modbus-RTU)
C8	M-Bus
C9	Ethernet interface PoE (Power over Ethernet) Modbus / TCP, 1 x 4 ... 20 mA analogue output (not electrically isolated), alarm relay, RS 485 (Modbus-RTU)

Special version analogue output	
D1	No special version
D2	Special version 2...10 V

Scaling analogue output	
E1	Standard scaling
E2	Special scaling 4...20 mA = 0...x g/m ³ , ppm, g/kg etc.

Sensor protection cap	
F1	Stainless steel sintered cap (~ 50 µm)
F2	perforated stainless steel cap

Connection thread	
G1	G 1/2"
G2	UNF 5/8"
G3	1/2" NPT

Maximum pressure	
H1	50 bar
H2	350 bar
H3	500 bar

Surface condition	
I1	standard version
I2	special cleaning - oil and grease free (e.g. for oxygen applications and so on)
I3	Silicone-free version including special cleaning oil- and grease-free

DESCRIPTION	ORDER NO.	TECHNICAL DATA FA 550
FA 550 Dew point sensor in robust die-cast aluminum housing	0699 0550	Measuring range: -80...20 °Ctd, -60...30 °Ctd, -20...50 °Ctd, or 0...100% RH
Further accessories:		Accuracy: ± 1 °C at +50...-20 °Ctd ± 2 °C at -20...-50 °Ctd ± 3 °C at -50...-80 °Ctd
Standard measuring chamber up to 16 bar	0699 3390	Pressure range: -1...50 bar, Special version up to 350 bar or 500 bar
High pressure measuring chamber for compressed air up to 350 bar	0699 3590	Power supply: 24 VDC (10...36 VDC)
Stainless steel bypass measuring chamber for dew point measurement in gases under pressure	0699 3290	Protection class: IP 67
Connection cables:		EMC: In acc. with DIN EN 61326-1
Connection cable for probes 5 m with open ends	0553 0108	Operating temperature: -20...50 °C
Connection cable for probes 10 m with open ends	0553 0109	Outputs: Standard: Modbus-RTU, 4...20 mA active (not electrically isolated), alarm relay (max. 48 VDC, 0.5 A) Options: See order code
Ethernet connection cable length 5 m, M12 plug x-coded (8 pin) to RJ 45 plug	0553 2503	Burden: < 500 Ω
Ethernet connection cable length 10 m, M12 plug x-coded (8 pin) to RJ 45 plug	0553 2504	Material: Die-cast aluminum housing, sensor tube stainless steel 1.4571
Power supply in wall housing for max. 2 sensors VA / FA series 5xx, 100-240 VAC, 23 VA, 50-60 Hz / 24 VDC, 0.35 A	0554 0110	Screw-in thread: G 1/2", optional 5/8" UNF, NPT 1/2"
CS Service Software VA 550 incl. interface cable to PC (USB) and power supply - for configuration / parametrisation VA 550/570	0554 2007	
PNG cable screwing - for FA 550, VA 550/570	0553 0552	
Calibration and adjustment:		
Precision calibration at -40 °Ctd or 3 °Ctd incl. ISO certificate	0699 3396	
Additional calibration point freely selectable	0700 7710	



FA 500 - Dew point sensor from -80 to 20 °Ctd

FA 500 is the ideal dew point measuring instrument with integrated display and alarm relay for refrigeration, membrane and adsorption dryers.



Special features:

- Integrated display
- Threshold value adjustable via keypad, alarm relay (max. 60 VDC, 0.5 A)
- Pressure-tight up to 500 bar (special version)
- Extremely stable in the long term
- Quick adaption time
- 4...20 mA analogue output for dew point
- Different refrigeration and adsorption dryer versions
- **NEW:** Modbus-RTU interface
- **NEW:** Higher resolution of sensor signal due to the improved evaluation electronics
- **NEW:** Sensor diagnosis on site with a portable device or CS Service Software

Readable via Modbus:

- Pressure dew point [°Ctd.]
- Temperature [°C]
- Rel. humidity [% RH]
- Abs. humidity [g/m³]
- Degree of humidity [g/m³]
- Moisture content V/V [ppmV/V]
- Water vapour particle pressure [hPa]
- Atmospheric dew point [°Ctd.atm]



The integrated keys enable simple, menu-controlled operation



Upper connection:

Power supply, 4...20 mA output, Modbus-RTU output

Lower connection:

Alarm relay



Option: Ethernet interface (PoE)

Easy operation via the keys on the display



The integrated display shows the dew point in big figures as well as further humidity parameters on two more display pages. The arrow key can be used to scroll between the display pages.

The alarm threshold value for the integrated relay can be freely entered via the keys. In addition to the alarm threshold, the hysteresis can also be freely entered.

The 4...20 mA analogue output can be scaled freely or also allocated to one further parameter, e. g. g/m³.

After entering the system pressure of the compressed air system and the reference pressure (atmospheric pressure), the sensor can also calculate back to the atmospheric dew point from the measured pressure dew point if desired.

DESCRIPTION	ORDER NO.
FA 500 dew point sensor for refrigeration dryers, -20...50 °Ctd	0699 0501
FA 500 dew point sensor for adsorption dryers, -80...20 °Ctd	0699 0502
FA 500 dew point sensor for adsorption dryers, -60...30 °Ctd	0699 0503
Connection cables:	
Connection cable for VA/FA series, 5 m	0553 0104
Connection cable for VA/FA sensors, 10 m	0553 0105
Cable for alarm/pulse output, with M12 plug, length 5 m	0553 0106
Cable for alarm/pulse output, with M12 plug, length 10 m	0553 0107
Ethernet connection cable length 5 m, M12 plug x-coded (8 pin) to RJ 45 plug	0553 2503
Ethernet connection cable length 10 m, M12 plug x-coded (8 pin) to RJ 45 plug	0553 2504
Options for FA 500:	
Option: Max. pressure FA5xx 350 bar	Z699 0515
Option: Max. pressure FA5xx 500 bar	Z699 0516
Option: Special scaling FA5xx 4...20 mA=___ ... __ g/m ³ , ppm etc.	Z699 0514
Option: connection thread FA5xx, 5/8" UNF	Z699 0511
Option: surface condition FA 5xx, free of oil & grease	Z699 0517
Ethernet-Interface for VA 500/520 and FA 500	Z695 5006
Ethernet-Interface PoE for VA 500/520 and FA 500	Z695 5007
M-Bus board for VA 500/520 and FA 500	Z695 5004
Further accessories:	
Standard measuring chamber for compressed air up to 16 bar	0699 3390
High pressure measuring chamber up to 350 bar	0699 3590
CS Service Software for FA/VA sensors incl. PC connection set, USB connection and interface adapter to the sensor	0554 2007
Mains unit in wall housing for maximum 2 sensors of the series VA/FA 5xx, 100-240 V, 23 VA, 50-60 Hz / 24 VDC, 0.35 A	0554 0110
AC adapter plug 100-240 VAC / 24 VDC for VA/FA 5xx	0554 0109
Calibration and adjustment:	
Precision calibration at -40 °Ctd or +3 °Ctd incl. ISO certificate	0699 3396

TECHNICAL DATA FA 500

Measuring range:	-80...20 °Ctd, -60...30 °Ctd, -20...50 °Ctd, or 0...100% RH
Accuracy:	± 1 °C at +50...-20 °Ctd ± 2 °C at -20...-50 °Ctd ± 3 °C at -50...-80 °Ctd
Pressure range:	-1...50 bar Special version up to 500 bar
Power supply:	24 VDC (10...36 VDC)
Protection class:	IP 65
EMC:	In acc. with DIN EN 61326-1
Operating temperature:	-20...50 °C
Connection:	2 x M12, 5-pin for analogue output, Modbus-RTU and alarm output, M-Bus (optional) Ethernet (PoE) (optional)
PC connection:	Modbus-RTU interface (RS 485)
Output: (3-wire)	4...20 mA = -80...20 °Ctd 4...20 mA = -60...30 °Ctd 4...20 mA = -20...50 °Ctd
Burden for analogue output:	< 500 Ω
Alarm relay:	NC, max. 60 VDC, 0.5 A
Screw-in thread:	G 1/2"
Dimensions housing:	76.5 x 85 x 75 mm (Wx-HxD)



DS 400 Dew point monitoring

For stationary dew point monitoring of refrigeration or adsorption dryers. The touch screen graphic display enables an intuitive operation and graphically shows the progress of the measured values. Two alarm relays are available for monitoring threshold values. Available interfaces are either a classic analogue output 4...20 mA or optionally digital interfaces such as Ethernet and RS 485 (Modbus protocol). As a stand-alone solution, the measured values stored in the optional data logger can be read-out via USB stick and evaluated on the computer by means of the software CS Basic.

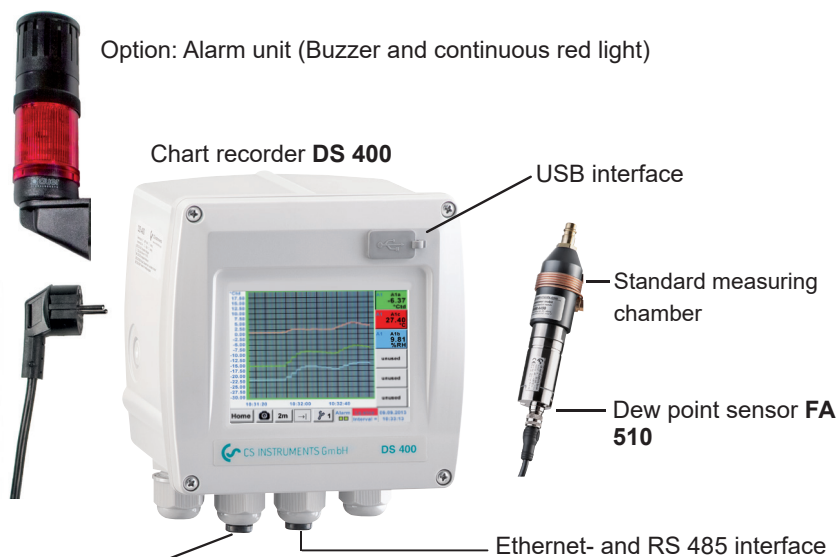

2nd sensor input for dew point or consumption sensors VA 500/520

SPECIAL FEATURES:

- 3.5" Graphic display – easy to use with touchscreen
- Plug-in system: everything wired and ready
- 2 alarm contacts (230 VAC, 3 A), pre-alarm and main alarm freely adjustable
- An alarm delay can be set for each alarm relay.
- 4...20 mA analogue output
- Option: Ethernet and RS 485 interface (Modbus protocols)
- Option: Web server

Transfer of data to the PC via USB stick



- **Option:** Integrated data logger
- Record dew point curve up to 100 million measured values
- CS Basic for evaluation in graphs and tables. Read out data either via USB stick or Ethernet

DESCRIPTION	ORDER NO.
Dew point monitoring DS 400 for adsorption dryers (-80...+20 °Ctd)	0601 0510
Dew point monitoring DS 400 for refrigeration dryers (-20...+50 °Ctd)	0601 0512
Options:	
Option: Integrated data logger for 100 million measured values	Z500 4002
Option: Integrated Ethernet and RS 485 interface	Z500 4004
Option: Integrated webserver	Z500 4005
Option: 2 additional sensor inputs for analogue sensors (pressure sensors, temperature sensors etc.)	Z500 4001
Further accessories	
CS Basic – data evaluation graphically and in table form - reading of the measured data via USB or Ethernet, licence for 2 workstations	0554 8040
Alarm unit mounted to the wall housing	Z500 0003
Alarm unit for external mounting with 5 m cable	Z500 0004
Calibration and adjustment	
Precision calibration at -40 °Ctd or +3 °Ctd incl. ISO certificate	0699 3396

TECHNICAL DS 400

Dimensions:	118 x 115 x 98 mm IP 54 (wall housing) 92 x 92 x 75 mm (panel mounting)
Inputs:	2 digital inputs for FA 510 or VA 500/520
Interface:	USB interface
Power supply:	100...240 VAC, 50-60 Hz
Accuracy:	See FA 510
Alarm outputs:	2 relays, (pot.-free)
Options:	
Data logger:	100 million measured values start/stop time, measuring rate freely adjustable
2 additional sensor inputs:	For connection of pressure sensors, temperature sensors, clamp-on ammeters, third-party sensors with 4...20 mA, 0 to 10 V, Pt 100, Pt 1000

TECHNICAL DATA FA 510

Measuring range:	-80...-20 °Ctd or -20...50 °Ctd
Accuracy:	± 1 °C at 50...-20 °Ctd ± 2 °C at -20...-50 °Ctd ± 3 °C at -50...-80 °Ctd
Pressure range:	-1...50 bar, special version 350 bar

Easy operation via touchscreen

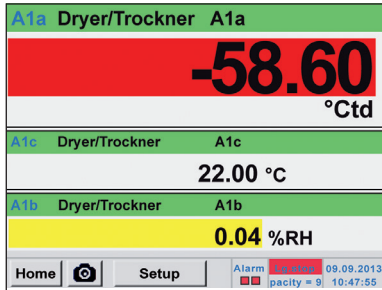

Actual measured values

All measured values can be seen at a glance. Threshold value exceedances are indicated in red color. A „measuring site name“ can be allocated to each sensor.

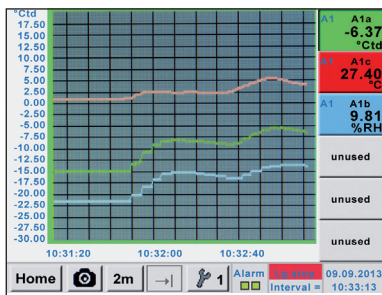

Graphic view

In the graphic view all measured values are indicated as curves. It is possible to browse back on the time axis by a slide of the finger (without data logger maximum 24 h, with data logger back to the start of the measurement).



Data logger

Measured values are stored in DS 400 by means of the option „integrated data logger“. The time interval can be freely set. Furthermore there is the possibility to fix the starting time and the end time of the data recording. Read-out of the measured data via USB interface or via the optional Ethernet interface.



Selection of the language

DS 400 „speaks“ several languages. The desired language can be selected via the selection button.

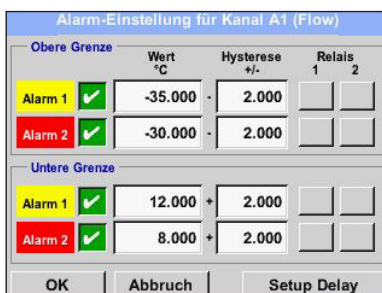

Adjustment of the alarm relays

Each one of the two alarm relays can be allocated individually to a connected sensor. The alarm thresholds and the hysteresis can be freely adjusted.

New: It is possible to set an alarm delay for each alarm relay so that the relay is only triggered after that period of time.



Accessories FA 500/510/515

**DESCRIPTION**

Diffusion-tight PTFE hose 6 mm with quick-lock coupling length 1 m
 Diffusion-tight PTFE hose 6 mm, length 1 m

ORDER NO.

0554 0003
 0554 0008

**DESCRIPTION**

Cooling section made of stainless steel

ORDER NO.

0699 3291

- 8 mm stainless steel tube wound as a spiral.
- With the cooling section, process gases from ovens etc. can be cooled from high temperatures to a sensor-compatible temperature of about 50°C. Falling below the dew point to be avoided.

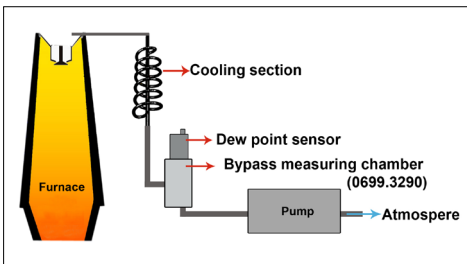
**DESCRIPTION**

Suction pump max. 0.9 l/min, 200 mbar for DP 510

ORDER NO.

0554 6520

**DESCRIPTION**

Quick-lock coupling NW 7,2 - G 1/2" male thread

ORDER NO.

0530 1101

**DESCRIPTION**

Control and calibration set 11.3% RH
 Control and calibration set 33% RH
 Control and calibration set 75.3% RH

ORDER NO.

0554 0002
 0554 0004
 0554 0005

- Control and calibration sets provide a defined humidity over a saturated saline solution
- The control and calibration set is screwed onto the dew point sensor and thus enables a simple and inexpensive control and calibration option down to -20 °Ctd dew point on site

Accessories FA 500/510/515



DESCRIPTION	ORDER NO.
Dry container for CS dew point sensors	0699 2500

- Guarantees sensor protection and quick adaption time. Recommended for storage of mobile sensors

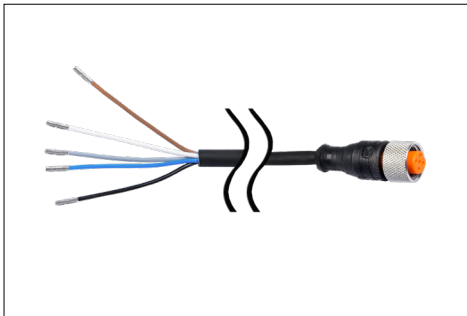

DESCRIPTION	ORDER NO.
Connection cable for VA/FA series, 5 m	0553 0104
Connection cable for VA/FA sensors, 10 m	0553 0105
Connection cable for VA/FA series, 20 m	0553 0120
Connection cable for VA/FA series, 5 m shielded	0553 0129
Connection cable for VA/FA series, 10 m shielded	0553 0130
Cable for alarm/pulse output, with M12 plug, 5 m	0553 0106
Cable for alarm/pulse output, with M12 plug, 10 m	0553 0107



DESCRIPTION	ORDER NO.
M12 plug for FA 500/510/515	0 2000 0082
M12 plug 90° angled	0219 0060



DESCRIPTION	ORDER NO.
Adapter plug FA 515/Michell easidew valve connector DIN 43650 form C 8 mm	0 2000 1389

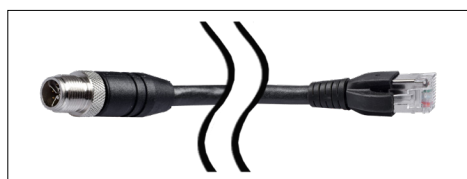

DESCRIPTION	ORDER NO.
Ethernet connection cable length 5 m, M12 plug x-coded (8 pin) to RJ 45 plug	0553 2503
Ethernet connection cable length 10 m, M12 plug x-coded (8 pin) to RJ 45 plug	0553 2504

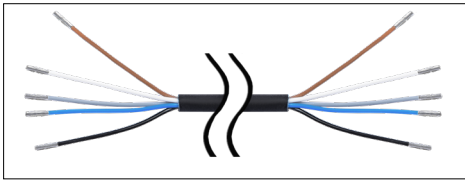

Accessories FA 550

**DESCRIPTION**

Connection cable 5 m with open ends
 Connection cable 10 m with open ends

ORDER NO.

0553 0108
 0553 0109

**DESCRIPTION**

PNG cable screwing - for standard

ORDER NO.

0553 0552

Accessories for all FA 5xx

**DESCRIPTION**

Mains unit in wall housing for maximum 2 sensors of the series VA/FA 5xx, 100-240 V, 23 VA, 50-60 Hz / 24 VDC, 0.35 A

ORDER NO.

0554 0110

**DESCRIPTION**

AC adapter plug 100-240 VAC / 24 VDC for VA/FA 5xx

ORDER NO.

0554 0109

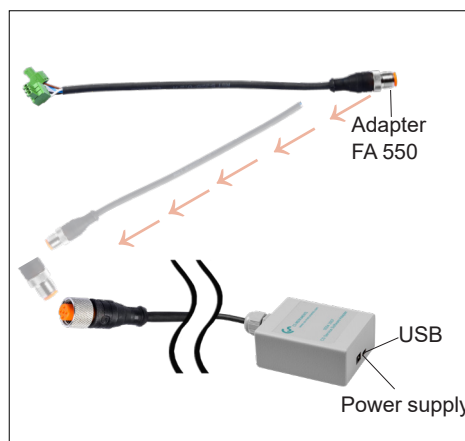
**DESCRIPTION**

CS Service Software incl. PC connection set, USB connection and interface adapter to the sensor

ORDER NO.

0554 2007

Measuring chambers



DESCRIPTION	ORDER NO.
Standard measuring chamber for compressed air	0699 3390

- Applicable for 2...16 bar
- Process connection: Plug nipple NW 7.2 (Parker series 26) or G 1/4" female thread when using without plug nipple
- Sensor connection: G 1/2" female thread
- Gives 2-3 liters / min of process air to the environment
- The copper capillary relaxes the compressed air and prevents the backflow of moisture from the ambient air into the measuring chamber



DESCRIPTION	ORDER NO.
Stainless steel measuring chamber for compressed air up to 50 bar	0699 3292

- Applicable for 2...50 bar
- Process connection: G 1/4" female thread
- Sensor connection: G 1/2" female thread
- Gives 2-3 liters / min of process air to the environment



DESCRIPTION	ORDER NO.
High pressure measuring chamber for compressed air up to 350 bar	0699 3590

- Applicable for 30...350 bar
- Process connection: G 1/4" female thread
- Sensor connection: G 1/2" female thread
- Emits 2-3 litres/min of process air to the environment via a fine nozzle
- Via the high-pressure valve, the amount of air for sampling can be adjusted individually depending on the pressure level. The process air is released to the environment via the sinter filter



DESCRIPTION	ORDER NO.
Stainless steel bypass measuring chamber for dew point measurement in gases under pressure	0699 3290

- Applicable for -1...500 bar
- Process connection: G 1/4" female thread gas inlet and G 1/4" female thread gas outlet
- Sensor connection: G 1/2" female thread
- The flow of at least 2 liters / min of gas must be ensured by the customer



DESCRIPTION	ORDER NO.
Standard measuring chamber for compressed air NPT 1/2"	0699 3393

- Applicable for 2...16 bar
- Process connection: NPT 1/2" male thread, or NPT 1/4" female thread for use without adapter
- Sensor connection: NPT 1/2" female thread
- Gives 2-3 liters / min of process air to the environment
- The copper capillary relaxes the compressed air and prevents the backflow of moisture from the ambient air into the measuring chamber



Measuring chambers

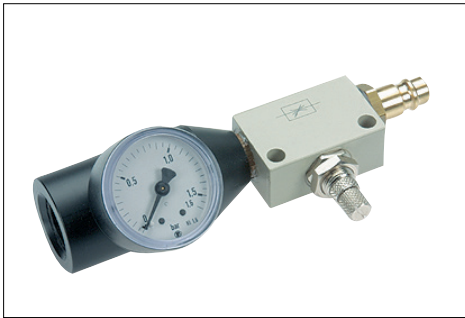

DESCRIPTION	ORDER NO.
Measuring chamber for atmospheric dew point	0699 3690
<ul style="list-style-type: none">• Applicable for 2...16 bar• Process connection: Plug nipple NW 7.2 (Parker series 26) or G 1/4" female thread when using without plug nipple• Sensor connection: G 1/2" female thread• Gives 2-3 liters / min of process air to the environment• The throttle valve in front of the measuring chamber relaxes the compressed air to atmospheric pressure in the measuring chamber. The manometer integrated in the measuring chamber indicates the overpressure to the atmosphere	



DESCRIPTION	ORDER NO.
Measuring chamber for granulate dryers and gases	0699 3490
<ul style="list-style-type: none">• Applicable for -1...16 bar• Process connection: Plug connection for 6 mm hose at inlet and outlet or G 1/4" female thread when using without plug connections• Sensor connection: G 1/2" female thread• The flow of at least 2 liters / min of air / gas must be ensured by the customer	

Notes



Calibration of dew point sensors

The calibration range for dew point sensors is from -80 °Ctd...20 °Ctd

Both dew point sensors from us and from other manufacturers can be calibrated. High precision reference measuring devices with DKD or BAM certificate guarantee an accuracy of up to 0.1 °C dew point.

Special feature:

Due to the digital data transmission, only the dew point sensor has to be calibrated. The display devices remain wired on site.



Calibration range: from -80 to 20 °Ctd -
Accuracy of the DKD reference: 0.1 °Ctd



Control and calibration set

Control and calibration sets provide a defined humidity over a saturated saline solution.

The control and calibration set is screwed onto the dew point sensor and therefore enables an easy and low-priced possibility for on-site control and calibration down to -20 °C dew point.

DESCRIPTION	ORDER NO.
Recalibration and precision calibration at -40 °Ctd or 3 °Ctd incl. ISO certificate	0699 3333
Precision calibration in the range -80...20 °Ctd, °Ctd points freely selectable	0700 7710
Control and calibration set 11.3% RH	0554 0002
Control and calibration set 33% RH	0554 0004
Control and calibration set 75.3% RH	0554 0005
Precision calibration at -40 °Ctd or 3 °Ctd incl. ISO certificate	0699 3396
Replacement unit for the period of re-calibration	0699 3900
Pressure dew point replacement sensor from our device pool including precision certificate at -40 °Ctd	0699 3990

CS Service Software

With the CS service software including the USB Modbus interface adapter, the FA 510 / FA 515 / FA 500 dew point sensors can be configured via laptop / PC. The following settings can be made via CS Service Software:



- Scaling of the 4...20 mA analogue output
- Assignment of the parameter to the analogue output (e.g. 4...20 mA = 0...10 g/m³)
- Available units: °Ctd, °Ftd, g/m³, mg/m³, ppmv/v, g/kg
- Reading out the firmware version, serial number, date of the last calibration
- One-point calibration (adjustment) of the sensors in the process. This requires a reference device
- Update of the sensor software (Firmware)
- Modbus settings as Modbus-ID, Baud rate, Stopbit, Parity

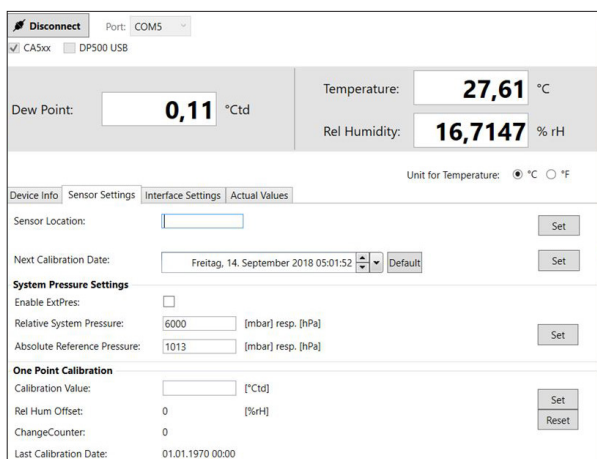
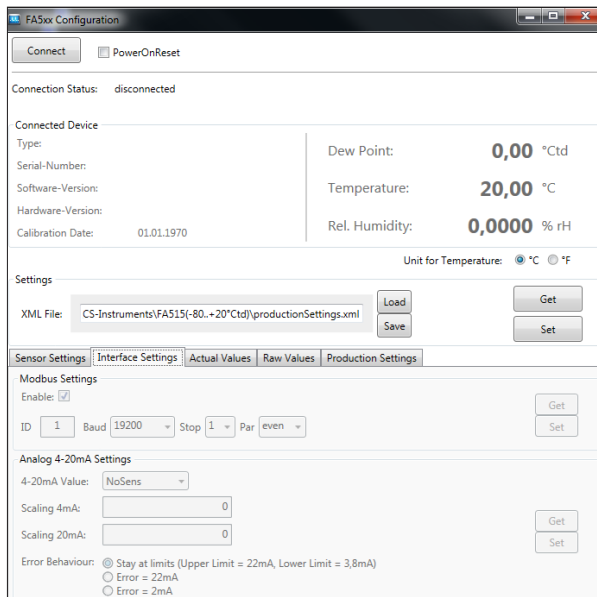

DESCRIPTION	ORDER NO.
CS Service Software incl. PC connection set, USB connection and interface adapter to the sensor	0554 2007



Dew point measurement in compressed air systems

Today, compressed air is an essential and reliable source of energy from modern production processes.

Depending on the particular application, different requirements are made on the compressed air. The compliance with a specific moisture content or dew point/pressure dew point is the basic prerequisite for a permanently trouble-free system operation for every process.

Especially for moisture measurement or dew point / pressure dew point measurement in compressed air and gases, we have developed the DS 400 measuring device with many new advantages.



Usually, compressed air is generated from ambient air which must be aspirated, compressed by using pistons or screw compressors and which must then be dried more or less strongly.

The aim is to produce dry and oil-free compressed air which is low in dust particles with the smallest possible effort. Residual oil and dust particles can be removed by means of complex filter systems.

However, moisture must be reduced by means of dryers (refrigeration dryers, membrane dryers, adsorption dryers and so on) which ideally work in a controlled manner independent of any load.

How does water get into compressed air?

Air is able to bind more water vapour the higher the temperature and the larger the volume. Conversely, if the air is compressed, the capacity to bind water vapour is reduced.

A compressor compresses atmospheric ambient air into a fraction of its original volume. At a certain point of the compression process the water content of the air exceeds the decreasing ability of the air to bind water. The air is saturated and part of the water drops out as condensate.

By means of an additional decrease of the temperature even more water will condensate.

This means that the relative humidity on the output of a compressor will always be at 100 % and that there will be additional water drops in the outgoing air.

The amount of liquid which drops out under pressure can be large. For example, a 30 kW compressor thus releases approximately 20 litres into the compressed air line at a humidity level of 60 % and an ambient temperature of 20 °C in eight hours. In case of big compressors this value will be much higher.

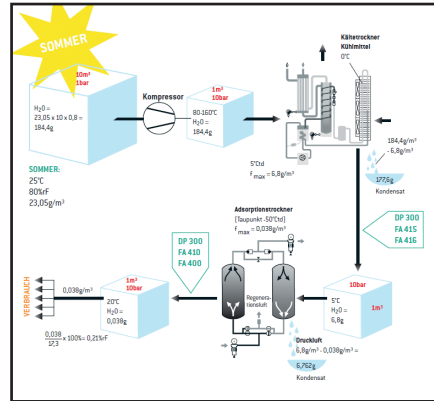

Effects of the moisture content

Depending on the application different demands are made on the compressed air. For each process the observance of a certain moisture content is the condition for a durably failure-free functioning of the whole system.

Most of the compressed air lines are made from steel or non zinc-coated steel. Since the corrosion speed strongly increases from a relative humidity of 50 % this value should not be exceeded in any case.

In the course of time, high moisture will lead to a corrosion in case of non zinc-coated lines. The rust gradually chips off and moves to the sampling points. This leads e. g. to blocked nozzles, defective control elements and production stops.

Expensive repairs and short maintenance intervals are inevitable. In addition to problems with corrosion and the described results the moisture content has direct influence on the quality of the final products.

Wich problems may arise in case of too high moisture?

In the following please find some of the most occurring samples:

- Hygroscopic products (spices, sugar etc.) get stuck together during transport by the pneumatic conveyor system
- Bubbles are formed during painting and coating processes
- Boreholes can clog up from dust being carried
- Control valves freeze over in winter in unheated halls 10610101

Empfohlene Druckluftqualitäten				
Anwendung	Druckluftqualitätsklassen nach DIN ISO 8573 - 1			
	Partikel		Restwasser	
	KL	µm	KL	DTP
Atemluft	1	0,1	1-3	-70/-20 °C
Spritzstolen	1	0,1	2	-40 °C
Medizintechnik	1	0,1	3-4	-20/+3 °C
Mess- und Regeltechnik	1	0,1	4	+3 °C
Förderung von Lebensmitteln und Getränken	2	1	3	-20 °C
Sandstrahlanlagen	--	--	4-3	+3/-20 °C
Allgemeine Werkluft	3	5	4	+3 °C
Aufbruchhammer	4	15	5-4	+7/+3 °C

Tasks of dryers

Different types of dryers are used in practice in order to control the problems of moisture levels that are too high.

In compressed air technology, the pressure dew point is the parameter for indicating the dryness of compressed air. The pressure dew point is the temperature at which the moisture which is contained in the compressed air condenses to form liquid water (also saturation, 100% relative humidity).

The lower the pressure dew point temperature, the smaller the amount of water vapour contained in the compressed air.



Refrigeration dryer for dew point parameters around +2 °Ctd.

There are different types of compressed air dryers; refrigeration dryers or adsorption dryers are the most commonly used ones.

Refrigeration dryers cool down the compressed air to approx. 2 to 5 °C. In this case, the pressure dew point is also 2 to 5 °C. The excess water vapour condenses and precipitates.

After that the air is again heated up to room temperature.

The refrigeration compressed air dryers are monitored in most cases only by a display of the cooling temperature. A stationary humidity monitor is hitherto only installed in large systems or in particularly important applications.

However, the display of the cooling temperature alone is not sufficient. Even if the cooling temperature seems to be OK, the following errors can cause an excessive pressure dew point:

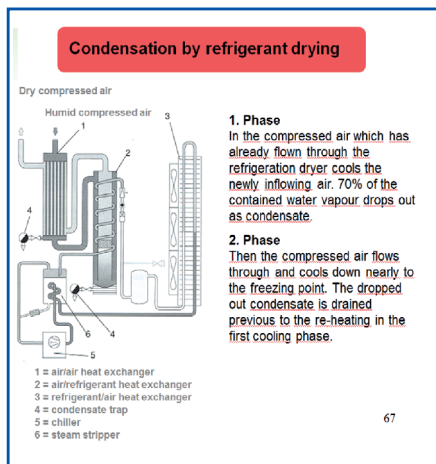

- **Condensate in the refrigeration dryer is not drained off (condensate drain defective resp. soiled)**
- **Compressed air bypass in the refrigeration dryer (close and corrode heat exchanger pipes and so on); compressed air bypass in bypass lines**
- **A failure of the refrigeration dryer inevitably leads to considerable problems with condensate in the compressed air line**

It is especially problematic (besides the already listed problems), if the condensate can concentrate in blind lines and does not drain off automatically. Condensate in blind lines can only be removed again by means of considerable efforts or dried and drained off by means of an extremely large amount of compressed air.

This often leads to increased dew point values at very low consumption rates, without the refrigeration dryer showing any obvious problems. In this case, it is quite difficult for the person who is responsible for compressed air to find out the reason for the increased dew point values or in extreme cases for the condensate in the long-term.

Adsorption dryers for typical dew points -30...-40 °Ctd.

The functioning of the adsorption dryer is based on the principle of the attraction between the two masses. Water vapor is bound (absorbed) at the surface of a desiccant.

Effective adsorption dryers are able to dry compressed air down to a pressure dew point of -40 °C and lower.

Regenerative adsorption dryer exist of two tanks which are filled with desiccant. In different procedures there is one tank regenerated cold resp. warm while the other one dries the operation air.

Depending on the procedure and the operating conditions the desiccant has to be exchanged in cycles of three to five years.

Certain operating conditions lead to a shortening of the life span of the desiccant:

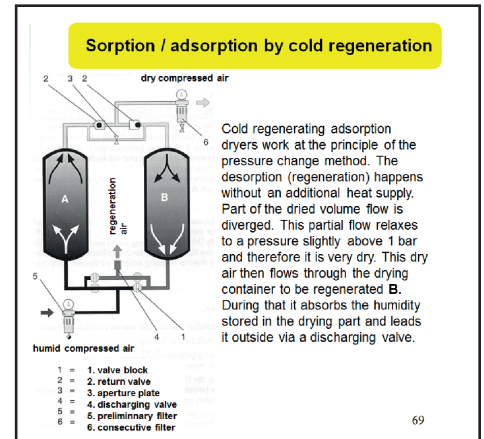

- **Overload on compressed air side due to excessive compressed air consumption**
- **Poor pre-separation of condensate**
- **Oily air**
- **Regeneration times of the individual tanks too long**

New: DS 400 dew point measurement with alarm ensures process reliability

Unique worldwide with 3.5" graphic display with touch screen and print function.

An alarm delay can be set for each relay. This grants that only really long-term threshold value exceedances are indicated. Additionally every alarm can be reset.



The dew point set DS 400 consists of the chart recorder DS 400 and the dew point sensor FA 510 including measuring chamber for the pressure dew point measurement of compressed air and gases up to 16/50/350 bar.

For pressures of more than 16 bar, please use the high-pressure measuring chamber.

The heart of the dew point sensor is the worldwide proven humidity sensor. In order to get quick and accurate measurements it is necessary that the humidity sensor is continuously flown by the gas (compressed air) to be measured. For this purpose a defined volume flow is blown out at a certain pressure via a capillary line.

The measuring chamber can be connected to the sampling point without any large installation efforts by means of the standard plug nipple for compressed air lines.

The big difference to customary paperless chart recorders is reflected in the simplicity of DS 400 on initiation and evaluation of the measured data.

The intuitive operation with the 3.5" touch screen graphic display with zoom function and print key is the only one of its kind in the world in this price category. By means of the graphic display with zoom function the drying procedure resp. the dew point curve can be seen at a glance and stored in the data logger. So the user can take a look at the stored measuring curves also without any computer at any time on site. This grants a quick and easy analysis of the drying behavior.

By means of the print key the actual screen can be stored as an image file to the internal SD card or to a USB stick and printed out at the computer without any additional software.

Ideal for documentation of the measured values/measurement curves on site.

Colored measurement curves can be sent by e-mail as image files or integrated into a service report.

The internal data logger enables the storage of the measured data for several years. The measured data can be evaluated on a USB stick or via Ethernet by means of the comfortable software CS Soft Basic.

Special features:

- **3.5" graphic display, intuitive operation via touch screen**
- **Zoom function for accurate analysis of measured values**
- **Colored measurement curves with names**
- **Mathematical calculation function for calculation of the dew point distance (condensate switch)**
- **Print key: optional indications can be stored as image files directly on a USB stick and sent by e-mail without any software**
- **2 alarm contacts for threshold value exceedance**
- **Freely adjustable alarm delay for both alarm contacts with reset function**
- **Up to 4 sensor inputs for: additional dew point, pressure, temperature, flow meters, electrical effective power meters, optional third-party sensors can be connected: Pt 100/ 1000, 0/4...20 mA, 0-1/10 V, Modbus, pulse**
- **Integrated data logger 8 GB**
- **USB, Ethernet interface, RS 485 / Modbus**
- **Web server**

VA 570 - Inline flow meter



Flange version

Version with pipe thread R thread or NPT thread

VA 570 is supplied with an integrated measuring section. The measuring sections are available in flanged version or with R resp. NPT thread.

A special feature is the removable measuring head. So the measuring unit can be removed easily and quickly for calibration or cleaning purposes without having to dismount the measuring section intricately. During this period the measuring section is sealed by a closing cap (accessory).

The screwing with a centring device is designed such that the sensor is positioned accurately in the centre when screwing it into the measuring section; furthermore, it enables an exact positioning in the flow direction. This eliminates unnecessary measuring faults.

Approvals:

 II 2 G Ex db IIC T4 Gb

 II 2 D Ex tb IIIC T90 °C Db

Special measurement technology features:

- 4 values on the display: Flow, total consumption, velocity, temperature. Units freely adjustable
- All measured values, settings such as gas type, inner diameter, serial number and so on can be accessed via Modbus-RTU
- Comprehensive diagnostic functions readable on the display or remote access via Modbus such as calibration cycle, error codes, serial number
- Notification in case of exceeding the calibration cycle
- Standard version accuracy 1.5% of m.v. \pm 0.3% of f.s.
- Precision version accuracy 1.0% of m.v. \pm 0.3% of f.s.
- Measuring span of 1 : 1000 (0.1 up to 224 m/s)
- Configuration and diagnosis via display, hand-held device PI 500, PC service software on-site
- Gas type (air, nitrogen, oxygen, argon and so on) freely adjustable via PC service software or external device DS 400, DS 500, PI 500
- Reference conditions °C and mbar/hPa freely adjustable
- Zero-point adjustment, leak flow volume suppression
- Pressure loss negligible



The sensor can be removed and cleaned

Special mechanical features:

- Robust impact-proof aluminium die cast housing for the outdoor area IP 67
- All wetted parts made from stainless steel 1.4404
- On request with DVGW approval for natural gas (up to 16 bar)
- Pressure range up to 16 bar, special version up to 40 bar
- Temperature range up to 180 °C
- No moveable parts, no wear
- Sensor tip very robust, easy to clean
- Housing rotatable, display rotatable by 180°

Measuring range - Flow VA 570

		1/2"	3/4"	1"	1 1/4"	1 1/2"	2"	2 1/2"	3"
		m³/h (cfm)	m³/h (cfm)	m³/h (cfm)	m³/h (cfm)	m³/h (cfm)	m³/h (cfm)	m³/h (cfm)	m³/h (cfm)
Reference conditions DIN 1945 / ISO 1217: 20 °C, 1000 mbar									
Air	Low-Speed (50 m/s)	20 (14)	45 (25)	75 (45)	140 (80)	195 (115)	320 (190)	550 (325)	765 (450)
	Standard (92.7 m/s)	45 (25)	85 (50)	145 (85)	265 (155)	365 (215)	600 (350)	1025 (600)	1420 (835)
	Max (185 m/s)	90 (50)	175 (100)	290 (170)	530 (310)	730 (430)	1195 (700)	2050 (1205)	2840 (1670)
	High-Speed (224 m/s)	110(60)	215 (125)	355 (210)	640 (375)	885 (520)	1450 (850)	2480 (1460)	3440 (2025)
Setting to DIN 1343: 0 °C, 1013.25 mbar									
Argon (Ar)	Low-Speed (50 m/s)	35 (20)	75 (40)	120 (70)	220 (130)	305 (180)	505 (295)	865 (510)	1200 (705)
	Standard (92.7 m/s)	70 (40)	135 (80)	230 (135)	415 (245)	570 (335)	935 (550)	1605 (945)	2225 (1310)
	Max (185 m/s)	140 (80)	275 (160)	460 (270)	830 (485)	1140 (670)	1870 (1100)	3205 (1885)	4440 (2615)
	High-Speed (224 m/s)	170 (100)	335 (195)	555 (325)	1005 (590)	1385 (815)	2265 (1330)	3880 (2285)	5380 (3165)
Carbondi-oxide (CO2)	Low-Speed (50 m/s)	20 (14)	45 (25)	75 (45)	140 (80)	195 (115)	320 (185)	545 (320)	760 (445)
	Standard (92.7 m/s)	45 (25)	85 (50)	145 (85)	260 (155)	360 (210)	590 (345)	1015 (595)	1405 (825)
	Max (185 m/s)	90 (50)	175 (100)	290 (170)	525 (305)	720 (425)	1185 (695)	2030 (1190)	2810 (1655)
	High-Speed (224 m/s)	105 (60)	210 (125)	350 (205)	635 (370)	875 (515)	1430 (840)	2455 (1445)	3405 (2000)
Nitrogen (N2)	Low-Speed (50 m/s)	20 (13)	40 (25)	70 (40)	130 (75)	180 (105)	295 (175)	505 (300)	705 (415)
	Standard (92.7 m/s)	40 (20)	80 (45)	135 (75)	240 (140)	335 (195)	550 (320)	945 (555)	1305 (770)
	Max (185 m/s)	80 (45)	160 (95)	270 (155)	485 (285)	670 (395)	1100 (645)	1885 (1110)	2610 (1535)
	High-Speed (224 m/s)	100 (55)	195 (115)	325 (190)	590 (345)	815 (475)	1330 (780)	2280 (1340)	3165 (1860)
Oxygen (O2)	Low-Speed (50 m/s)	20 (13)	45 (25)	75 (40)	135 (80)	185 (110)	305 (180)	525 (310)	730 (430)
	Standard (92.7 m/s)	40 (25)	80 (45)	140 (80)	250 (145)	345 (205)	570 (335)	980 (575)	1355 (795)
	Max (185 m/s)	85 (50)	165 (95)	280 (165)	505 (295)	695 (410)	1140 (670)	1955 (1150)	2710 (1590)
	High-Speed (224 m/s)	105 (60)	205 (120)	340 (200)	610 (360)	845 (495)	1380 (810)	2365 (1390)	3280 (1930)
Nitrous oxide (N2O)	Low-Speed (50 m/s)	20 (14)	45 (25)	75 (45)	140 (80)	190 (110)	315 (185)	540 (320)	750 (440)
	Standard (92.7 m/s)	40 (25)	85 (50)	140 (85)	260 (150)	355 (210)	585 (345)	1005 (590)	1395 (820)
	Max (185 m/s)	85 (50)	170 (100)	285 (170)	520 (305)	715 (420)	1170 (690)	2010 (1180)	2785 (1640)
	High-Speed (224 m/s)	105 (60)	210 (120)	345 (205)	630 (370)	865 (510)	1420 (835)	2435 (1430)	3375 (1985)
Natural gas (NG)	Low-Speed (50 m/s)	14,4 (8)	25 (15)	45 (25)	85 (50)	115 (65)	190 (110)	325 (190)	450 (265)
	Standard (92.7 m/s)	25 (15)	50 (30)	85 (50)	155 (90)	215 (125)	355 (205)	605 (355)	840 (495)
	Max (185 m/s)	50 (30)	105 (60)	170 (100)	310 (185)	430 (250)	705 (415)	1210 (710)	1680 (985)
	High-Speed (224 m/s)	65 (35)	125 (70)	210 (120)	380 (220)	520 (305)	855 (500)	1465 (865)	2035 (1195)



Optional: Connection to different Bus systems

There are different options available for connection to modern Bus systems:

- Ethernet interface (Modbus-TCP) / PoE
- M-BUS
- Modbus-RTU
- Profibus DP interface (in process)
- Profinet interface (in process)
- HART (in process)



Ethernet Modbus TCP

M12 Ethernet port, x-coded

HART

**P R O F I
B U S**

**P R O F I
N E T**

M-Bus

For further accessories refer to pages 106 to 110

VA 570 - Inline flow meter

Example order code VA 570:

0695 0570_A1_B1_C1_D1_E1_F1_G1_H1_I1_J1_K1_L1_M1_R1

Male thread measuring section	
A1	R male thread
A2	NPT male thread
A3	Flange DIN EN 1092-1
A4	Flange ANSI 16.5 Class 150 lbs
A5	Flange ANSI 16.5 Class 300 lbs

Display option	
B1	with integrated display
B2	without display

Option signal outputs / bus connection	
C1	2 units 4...20 mA analogue output (electrically isolated), pulse output, RS 485 (Modbus-RTU)
C4	1 x 4...20 mA analogue output (not electrically isolated), pulse output, RS 485 (Modbus-RTU)
C5	Ethernet interface (Modbus / TCP), 1 x 4...20 mA analogue output (not electrically isolated), pulse output, RS 485 (Modbus-RTU)
C8	M-Bus, 1 x 4...20 mA analogue output (not electrically isolated), pulse output, RS 485 (Modbus-RTU)
C9	Ethernet interface PoE (Power over Ethernet) (Modbus/TCP), 1 x 4...20 mA analogue output (not electrically isolated), pulse output, RS 485 (Modbus-RTU)

Adjustment/calibration	
D1	No real gas adjustment - gas type configuration per gas constant
D2	Real gas adjustment in the gas type selected below

Gas type	
E1	Compressed air
E2	Nitrogen (N2)
E3	Argon (Ar)
E4	Carbon dioxide (CO2)
E5	Oxygen (O2)
E6	Nitrous oxide (N2O)
E7	Natural gas (NG)
E8	Helium (He) (real gas adjustment D2 required)
E9	Propane (C3H8) (real gas adjustment D2 required)
E10	Methane (CH4)
E11	Biogas (methane 50% : CO2 50%)
E12	Hydrogen (H2) (real gas adjustment D2 required)
E90	Further gas / please indicate gas type (on request)
E91	Gas mixture / please indicate mixture ratio (on request)

Reference standard	
F1	20 °C, 1000 mbar
F2	0 °C, 1013.25 mbar
F3	15 °C, 981 mbar
F4	15 °C, 1013.25 mbar

Maximum pressure	
G1	16 bar
G2	40 bar

Surface condition	
H1	standard version
H2	Special cleaning - oil and grease free (e. g. for oxygen applications and so on)
H3	Silicone-free version including special cleaning oil- and grease-free

Accuracy class	
I1	± 1.5% of the measured value ± 0.3% f.s. (standard)
I2	± 1% of the measured value ± 0.3% f.s. (precision)

Maximum gas temperature on the sensor tip	
J1	up to 120 °C gas temperature (only for ATEX version)
J2	up to 180 °C gas temperature (standard)

Approvals	
K1	Non-explosive area - no approval
K2	ATEX II 2G Ex d IIC T4 ATEX II 2D Ex tb IIIC T90 °C, Db
K3	DVGW approval for natural gas (max. pressure 16 bar)

Measuring range (see table)	
M1	Max version (185 m/s)
M2	Low-speed version (50 m/s)
M3	Standard version (92,7 m/s)
M4	High-speed version (224 m/s)

Special measuring range	
R1	Special measuring range (please specify when placing order)

Order no. VA 570

DESCRIPTION	ORDER NO.	TECHNICAL DATA VA 570
VA 570 flow meter with integrated 1/2" measuring section	0695 0570 + order code A...R_	<p>Measuring range VA 570: up to 50 Nm/s, low-speed version* up to 92.7 Nm/s, standard version* up to 185 Nm/s, max. version* up to 224 Nm/s, high-speed version*</p> <p>* Measuring range Nm³/h for different pipe diameters and gases, see table measuring ranges flow</p> <p>* All measured values related to DIN 1343 standard conditions 0° and 1013 mbar ex works</p> <p>Accuracy: ± 1.5% of m.v. ± 0.3 % of f.s. Accuracy class (o. M. V. = of measured value) (o. F. S. = of full scale) Accuracy indications: ± 1.0% of m.v. ± 0.3 % of f.s.</p> <p>Repeatability: relative to ambient temperature 22 °C ± 2 °C, system pressure 6 bar</p> <p>Measuring principle: 0.25% of m.v. in case of correct mounting (mounting aid, position, inlet section) Thermal mass flow sensor</p> <p>Response time: t90 < 3 s</p> <p>Operating temperature range sensor tube/display unit: -40...180 °C standard version, sensor tube -20...70 °C display unit -20...120 °C for ATEX version</p> <p>Adjustment possibilities via display, external hand-held device PI 500, PC Service Software, remote diagnosis: Nm³/h, Nm³/min, NI/min, l/s, ft/min, cfm, kg/h, kg/min, inner diameter, reference conditions ° C/° F, mbar/hPa, zero point correction, leak flow volume suppression, scaling analogue output 4...20 mA, pulse/alarm, error codes etc.</p> <p>Outputs: Standard: 1 x 4...20 mA analogue output (not electrically isolated), pulse output, RS 485 (Modbus-RTU) Optional: 2 x 4 ... 20 mA active, Modbus TCP, HART, Profibus DP, Profinet, M-Bus</p> <p>Burden: < 500 Ohm</p> <p>Additional average value calculation: for all parameters freely adjustable from 1 minute up to 1 day, e. g. 1/2 hours average value, average day value</p> <p>Protection class: IP 67</p> <p>Material: Die-cast aluminum housing, sensor tube stainless steel 1.4404</p> <p>Operating pressure: 16 bar, in special version 40 bar</p> <p>Power supply: 18...36 VDC, 5 W</p> <p>Approval: ATEX II 2G Ex db IIC T4 Gb, ATEX II 2D Ex tb IIC T90 °C, Db, DVGW</p>
VA 570 flow meter with integrated 3/4" measuring section	0695 0571	
VA 570 flow meter with integrated 1" measuring section	0695 0572	
VA 570 flow meter with integrated 1 1/4" measuring section	0695 0573	
VA 570 flow meter with integrated 1 1/2" measuring section	0695 0574	
VA 570 flow meter with integrated 2" measuring section	0695 0575	
VA 570 flow meter with integrated DN 15 measuring section with flange	0695 2570	
VA 570 flow meter with integrated DN 20 measuring section with flange	0695 2571	
VA 570 flow meter with integrated DN 25 measuring section with flange	0695 2572	
VA 570 flow meter with integrated DN 32 measuring section with flange	0695 2573	
VA 570 flow meter with integrated DN 40 measuring section with flange	0695 2574	
VA 570 flow meter with integrated DN 50 measuring section with flange	0695 2575	
VA 570 flow meter with integrated DN 65 measuring section with flange	0695 2576	
VA 570 flow meter with integrated DN 80 measuring section with flange	0695 2577	
Further accessories:		
Closing cap for measuring section in aluminium	0190 0001	
Closing cap for measuring section stainless steel 1.4404	0190 0002	
Connection cable for probes 5 m with open ends	0553 0108	
Connection cable for probes 10 m with open ends	0553 0109	
Ethernet connection cable length 5 m, M12 plug x-coded (8 pin) to RJ 45 plug	0553 2503	
Ethernet connection cable length 10 m, M12 plug x-coded (8 pin) to RJ 45 plug	0553 2504	
Mains unit in wall housing for maximum 2 sensors of the series VA/FA 5xx, 100-240 V, 23 VA, 50-60 Hz / 24 VDC, 0.35 A	0554 0110	
ISO calibration certificate at 5 measuring points for VA sensors	3200 0001	
Additional calibration point (point freely selectable) Volume flow	0700 7720	
CS Service Software VA 550 incl. interface cable to PC (USB) and power supply - for configuration / parametrisation of VA 550	0554 2007	
PNG cable screwing - standard VA 550/570	0553 0552	
PNG cable screwing - for ATEX version VA 550/570	0553 0551	

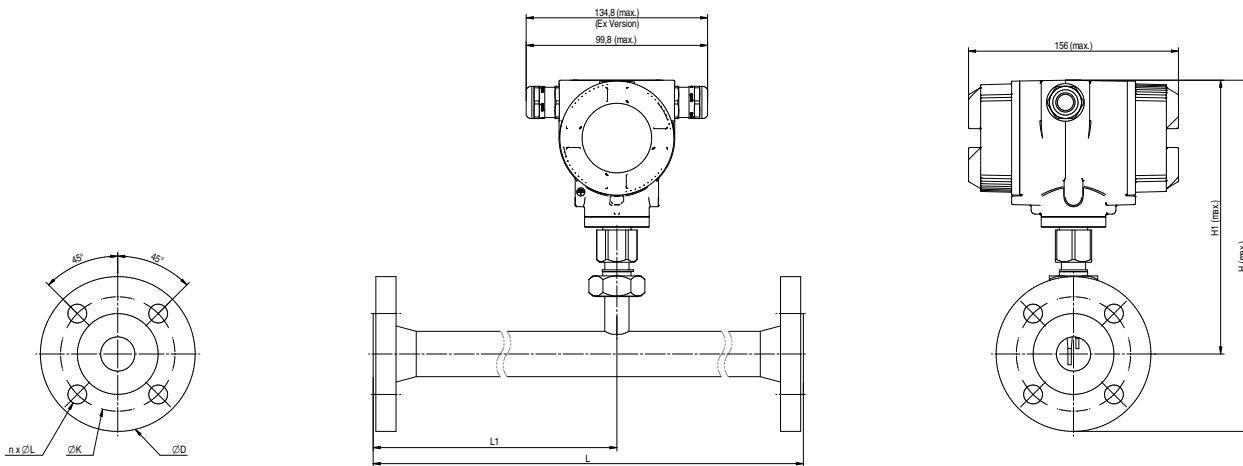

VA 570 - with flange

Pipe size	AD pipe - mm	ID pipe - mm	L - mm	L1 - mm	H - mm	H1 - mm	Flange DIN EN 1092-1		
							Ø D	Ø K	n x Ø L
DN 15	21.3	16.1	300*	210	267	218	95	65	4 x 14
DN 20	26.9	21.7	475*	275	270	218	105	75	4 x 14
DN 25	33.7	27.3	475*	275	275	218	115	85	4 x 14
DN 32	42.4	36.0	475*	275	288	218	140	100	4 x 18
DN 40	48.3	41.9	475*	275	293	218	150	110	4 x 18
DN 50	60.3	53.1	475*	275	300	218	165	125	4 x 18
DN 65	76.1	68.9	475*	275	320	228	185	145	8 x 18
DN 80	88.9	80.9	475*	275	328	228	200	160	8 x 18

*Attention: Shortened inlet section. Please observe the recommended minimum inlet section (length = 15 x inner diameter)!

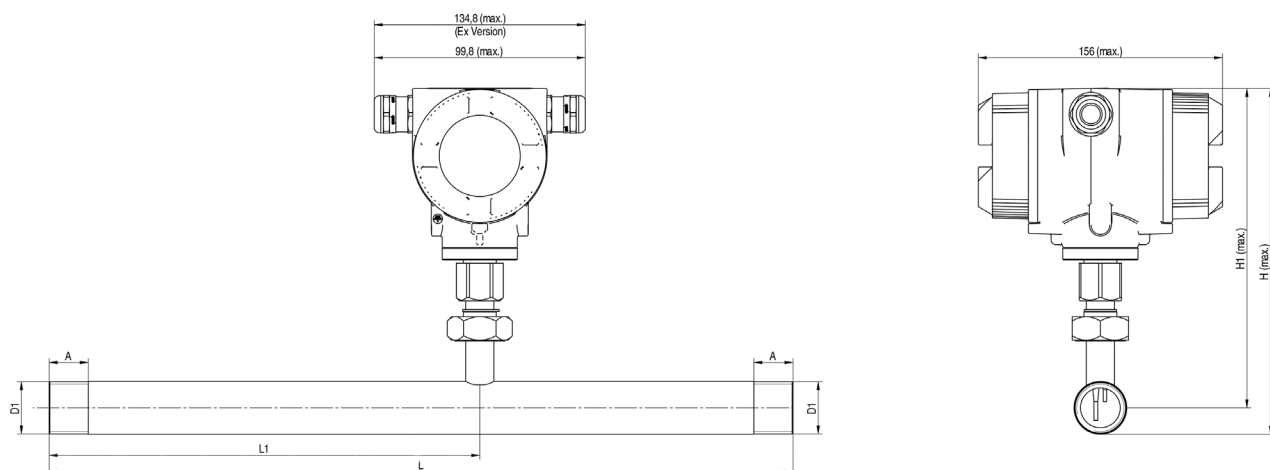

VA 570 - Threaded version

Connection thread	AD pipe - mm	ID pipe - mm	L - mm	L1 - mm	H - mm	H1 - mm	A - mm
R 1/2"	21.3	16.1	300*	210	228	218	20
R 3/4"	26.9	21.7	475*	275	231	218	20
R 1"	33.7	27.3	475*	275	235	218	25
R 1 1/4"	42.4	36.0	475*	275	239	218	25
R 1 1/2"	48.3	41.9	475*	275	242	218	25
R 2"	60.3	53.1	475*	275	248	218	30

*Attention: Shortened inlet section. Please observe the recommended minimum inlet section (length = 15 x inner diameter) on site!

Notes

VA 550 - Flow meter insertion type



Flow sensor for installation in existing compressed air or gas line of 3/4" to DN 1000



Housing IP 67

Outputs:
4...20 mA, pulse, Modbus,
M-Bus, Profi Bus, Ethernet,
HART

Housing rotatable, display
180° rotatable (on the head).
Settings can be modified via
display, flow meter can be
reset



Advantages of optical keys:

The sensor can also be config-
ured in the ATEX area, without
the housing needing to be
opened.

All wetted parts made from stain-
less steel 1.4571



Approvals:

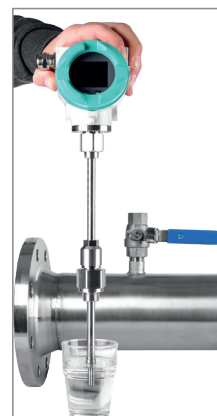
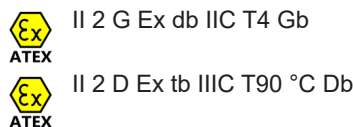

The sensor can
be removed and
cleaned

Special measurement technology features:

- 4 values on the display: Flow, total consumption, velocity, temperature. Units freely adjustable
- All measured values, settings such as gas type, inner diameter, serial number and so on can be accessed via Modbus-RTU
- Comprehensive diagnostic functions readable on the display or remote access via Modbus such as calibration cycle, error codes, serial number
- Notification in case of exceeding the calibration cycle
- Standard version accuracy 1.5% of m.v. ± 0.3% of f.s.
- Precision version accuracy 1.0% of m.v. ± 0.3% of f.s.
- Measuring span of 1 : 1000 (0.1 up to 224 m/s)
- Configuration and diagnosis via display, hand-held device PI 500, PC service software on-site
- Gas type (air, nitrogen, oxygen, argon and so on) freely adjustable via PC service software or external device DS 400, DS 500, PI 500
- Reference conditions °C and mbar/hPa freely adjustable
- Zero-point adjustment, leak flow volume suppression
- Pressure loss negligible

Special mechanical features:

- Robust impact-proof aluminium die cast housing for the outdoor area IP 67
- All wetted parts made from stainless steel 1.4571
- Suitable as an insertion version for 3/4" to DN 1000
- On request with DVGW approval for natural gas (up to 16 bar)
- Pressure range up to 50 bar, special version up to 100 bar
- Temperature range up to 180 °C
- No moveable parts, no wear
- Sensor tip very robust, easy to clean
- Easy installation and removal under pressure via 1/2" ball valve
- Housing rotatable, display rotatable by 180°
- Safety ring for installation and removal under pressure
- Depth scale for precise installation

Easy mounting/dismounting of **VA 550** under pressure - without disconnection of the line - without emptying the line

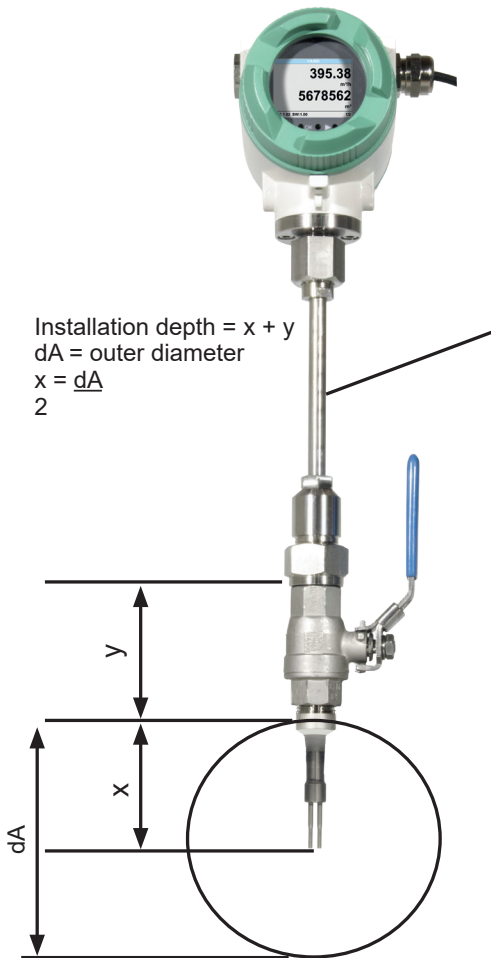

Engraved depth scale for precise installation

	180
	170
	160

If there is no suitable measuring site with 1/2" ball valve, there are two simple possibilities to set up a measuring site:

A Weld on a 1/2" screw neck and screw on a 1/2" ball valve

B Mount spot drilling collar including ball valve

By means of the drilling jig, it is possible to drill under pressure through the 1/2" ball valve into the existing pipe. The drilling chips are collected in a filter. Then the probe can be mounted.



A Screw neck

Order no.: 3300 0006

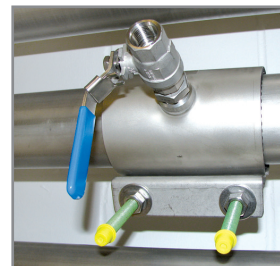

B Spot drilling collars

Order no.: see page 110



Drill under pressure with the CS drilling jig

Order no.: 0530 1108



Optional: Connection to different Bus systems

There are different options available for connection to modern Bus systems:

- Ethernet interface (Modbus-TCP) / PoE
- M-BUS
- Modbus-RTU
- Profibus DP interface (in process)
- Profinet interface (in process)
- HART (in process)



Ethernet Modbus TCP
M12 Ethernet port, x-coded

For further accessories refer to pages 106 to 110

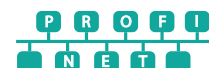
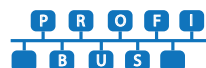

VA 550 - Flow meter insertion meter

Example order code VA 550:

0695 0550_A1_B1_C1_D1_E1_F1_G1_H1_I1_J1_K1_L1_M1_R1

Measuring range (see table page 114 to 117)

A1	Standard version (92,7 m/s)
A2	Max version (185 m/s)
A3	High-speed version (224 m/s)
A4	Low-speed version (50 m/s)

Screw-in thread

B1	G 1/2" male thread
B2	1/2" NPT male thread

Installation length / shaft length

C1	220 mm
C2	300 mm
C3	400 mm
C4	500 mm
C5	600 mm
C6	700 mm (not with ATEX)
C7	160 mm
C8	1000 mm (not with ATEX)
C9	1500 mm (not with ATEX)

Display option

D1	with integrated display
D2	without display

Signal outputs / bus connection option

E1	2 units 4...20 mA analogue output (electrically isolated), pulse output, RS 485 (Modbus-RTU)
E4	1 x 4...20 mA analogue output (not electrically isolated), pulse output, RS 485 (Modbus-RTU)
E5	Ethernet interface (Modbus / TCP), 1 x 4...20 mA analogue output (not electrically isolated), pulse output, RS 485 (Modbus-RTU)
E8	M-Bus, 1 x 4...20 mA analogue output (not electrically isolated), pulse output, RS 485 (Modbus-RTU)
E9	Ethernet interface PoE (Power over Ethernet) (Modbus/TCP), 1 x 4...20 mA analogue output (not electrically isolated), pulse output, RS 485 (Modbus-RTU)

Adjustment / calibration

F1	No real gas adjustment - gas type configuration per gas constant
F2	Real gas adjustment in the gas type selected below

Gas type

G1	Compressed air
G2	Nitrogen (N2)
G3	Argon (Ar)
G4	Carbon dioxide (CO2)
G5	Oxygen (O2)
G6	Nitrous oxide (N2O)
G7	Natural gas (NG)
G8	Helium (He) (real gas adjustment F2 required)
G9	Propane (C3H8) (real gas adjustment F2 required)
G10	Methane (CH4)
G11	Biogas (methane 50% : CO2 50%)
G12	Hydrogen (H2) (real gas adjustment F2 required)
G90	Further gas / please indicate gas type (on request)
G91	Gas mixture / please indicate mixture ratio (on request)

Maximum pressure (more than 10 bar high-pressure protection required!)

H1	50 bar
H2	100 bar
H3	16 bar

Surface condition

I1	standard version
I2	special cleaning - oil and grease free (e.g. for oxygen applications and so on)
I3	Silicone-free version including special cleaning oil- and grease-free

Accuracy class

J1	± 1.5% of the measured value ± 0.3% f.s. (standard)
J2	± 1% of the measured value ± 0.3% f.s. (precision)

Maximum gas temperature on the sensor tip

K1	up to 120 °C gas temperature (only for ATEX version)
K2	up to 180 °C gas temperature (standard)

Approvals

L1	Non-explosive area - no approval
L2	ATEX II 2G Ex db IIC T4 Gb ATEX II 2D Ex tb IIIC T90 °C, Db
L3	DVGW approval for natural gas (max. pressure 16 bar)

Reference standard

M1	20 °C, 1000 mbar
M2	0 °C, 1013.25 mbar
M3	15 °C, 981 mbar
M4	15 °C, 1013.25 mbar

Special measuring range

R1	Special measuring range (please specify when placing order)
----	---

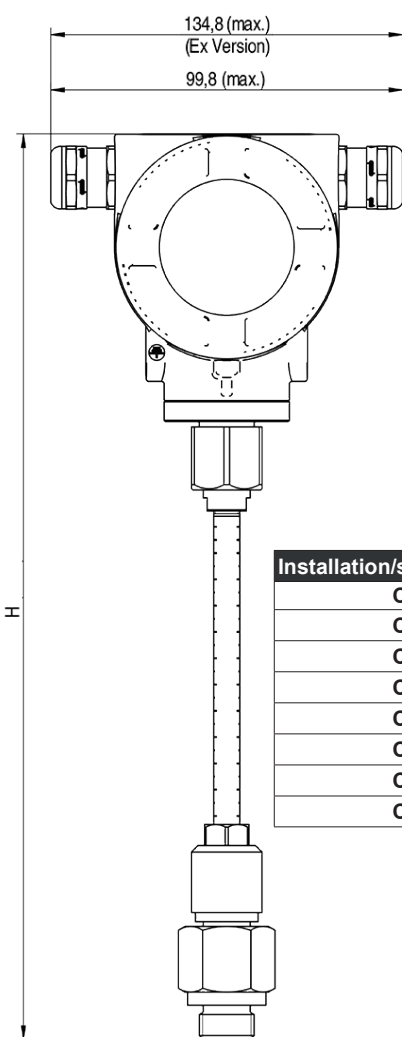

Installation/shaft length	L (mm)	H (mm)
C1	220	441
C2	300	521
C3	400	621
C4	500	721
C5	600	821
C7	160	381
C8	1000	1221
C8	1500	1721

Further accessories:

DESCRIPTION	ORDER NO.
Connection cable for probes 5 m with open ends	0553 0108
Connection cable for probes 10 m with open ends	0553 0109
Ethernet connection cable length 5 m, M12 plug x-coded (8 pin) to RJ 45 plug	0553 2503
Ethernet connection cable length 10 m, M12 plug x-coded (8 pin) to RJ 45 plug	0553 2504
Mains unit in wall housing for maximum 2 sensors of the series VA/FA 5xx, 100-240 V, 23 VA, 50-60 Hz / 24 VDC, 0.35 A	0554 0110
ISO calibration certificate at 5 measuring points for VA 500/550	3200 0001
Additional calibration point for volume flow (point freely selectable)	0700 7720
CS Service Software VA 550 incl. interface cable to PC (USB) and power supply - for configuration / parametrization of VA 550	0554 2007
High-pressure protection recommended for installation from 10 to 100 bar (for VA 550)	0530 1115
High-pressure protection recommended for installation from 10 to 16 bar DVGW (for VA 550)	0530 1116
PNG cable screwing - standard VA 550/570	0553 0552
PNG cable screwing - for ATEX version VA 550/570	0553 0551

Order no. VA 550

DESCRIPTION	ORDER NO.
VA 550 Flow meter, measuring head in robust aluminium die casting housing	0695 0550 + Order code A...R_

TECHNICAL DATA VA 550

Measuring range VA 550:	up to 50 Nm/s, low-speed version* up to 92.7 Nm/s, standard version* up to 185 Nm/s, max. version* up to 224 Nm/s, high-speed version*
	* Measuring range Nm ³ /h for different pipe diameters and gases, see table measuring ranges flow * All measured values related to DIN 1343 standard conditions 0° and 1013 mbar ex works
Accuracy: Accuracy class (o. M. V. = of measured value) (o. F. S. = of full scale)	± 1.5 % of m.v. ± 0.3 % of f.s. on request: ± 1.0 % of m.v. ± 0.3 % of f.s.
Accuracy indications:	relative to ambient temperature 22 °C ± 2 °C, system pressure 6 bar
Repeatability:	0.25 % of m.v. in case of correct mounting (mounting aid, position, inlet section)
Measuring principle:	Thermal mass flow sensor
Response time:	t 90 < 3 s
Operating temperature range sensor tube/display unit:	-40...180 °C standard version, sensor tube -20...70 °C display unit -20...120 °C for ATEX version
Adjustment possibilities via display, external hand-held device PI 500, PC Service Software, remote diagnosis:	Nm ³ /h, Nm ³ /min, Nl/min, l/s, ft/min, cfm, kg/h, kg/min, inner diameter, reference conditions ° C/° F, mbar/hPa, zero point correction, leak flow volume suppression, scaling analogue output 4...20 mA, pulse/alarm, error codes etc.
Outputs:	Standard: 1 x 4...20 mA analogue output (electrically not isolated), pulse output, RS 485 (Modbus-RTU) Optional: 2 x 4...20 mA active, Modbus TCP, HART, Profibus DP, Profinet, M-Bus
Burden:	< 500 ohm
Additional average value calculation:	for all parameters freely adjustable from 1 minute up to 1 day, e. g. 1/2 hours average value, average day value
Protection class:	IP 67
Material:	Die-cast aluminum housing, sensor tube stainless steel 1.4571
Screw-in thread:	G 1/2" ISO 228, NPT 1/2", R 1/2", PT 1/2"
Operating pressure VA 550:	50 bar, in special version 100 bar (with DVGW approval max. 16 bar)
Power supply:	18...36 VDC, 5 W
Approval:	ATEX II 2G Ex db IIC T4 Gb, ATEX II 2D Ex tb IIC T90 °C, Db, DVGW

VA 500 - Flow meter for compressed air and gases

NEW:
As option, integrated pressure sensor

Bewegliches Montagegewinde G 1/2"

Sicherungsring Ø 11,7 mm

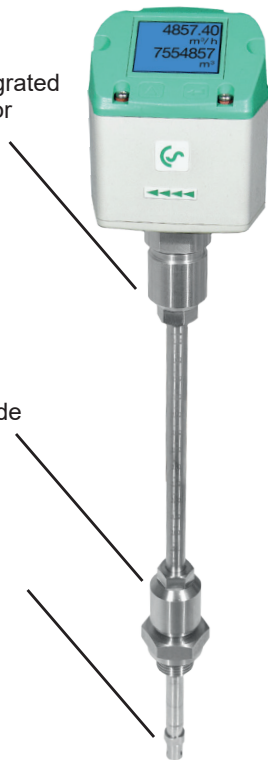

Special features:

- Including temperature measurement, optional: pressure measurement
- RS 485 interface, Modbus-RTU as standard
- Integrated display for m³/h and m³
- Applicable from 1/2" to DN 1000
- Easy installation under pressure
- 4...20 mA analogue output for m³/h or m³/min
- Pulse output for m³ or M-Bus (optional)
- Inner diameter adjustable by means of keys
- Flow meter can be reset
- Adjustable by means of keypad on the display: Reference conditions, °C and mbar, 4...20 mA scaling, pulse weight

TECHNICAL DATA VA 500

Parameters:	m ³ /h, l/min (1000 mbar, 20 °C) in case of compressed air or Nm ³ /h, Nl/min (1013 mbar, 0 °C) in case of gases
Units adjustable via keys at display:	m ³ /h, m ³ /min, l/min, l/s, ft/min, cfm, m/s, kg/h, kg/min, g/s, lb/min, lb/h
Adjustable via keypad:	Diameter for volume flow calculation, counter resettable
Sensor:	Thermal mass flow sensor
Measured medium:	Air, gases
Gas types are adjustable over CS service software or CS data logger:	Air, nitrogen, argon, helium, CO ₂ , oxygen, vacuum
Measuring range:	See table page 12
Accuracy: (m.v.: of meas. value) (f.s.: of full scale)	± 1.5% of m.v. ± 0.3 % of f.s. on request: ± 1% of m.v. ± 0.3% of f.s.
Operating temperature:	-30...110 °C sensor tube -20...85 °C with pressure sensor -20...+70 °C housing
Operating pressure:	-1...50 bar (for pressure > 10 bar - order additional high-pressure protection)
Digital output:	RS 485 interface, (Modbus-RTU), optional: Ethernet interface PoE, M-Bus
Analogue output:	4...20 mA for m ³ /h or l/min
Pulse output:	1 pulse per m ³ or per litre electrically isolated. Pulse weight can be set on the display. Alternatively, the pulse output can be used as an alarm
Supply:	18...36 VDC, 5 W
Burden:	< 500 Ω
Housing:	Polycarbonate (IP 65)
Sensor tube:	Stainless steel, 1.4301 Installation length 220 mm, Ø 10 mm
Mounting thread:	G 1/2", 1/2" NPT male thread
Ø housing:	65 mm
Mounting position:	any



Inner diameter adjustable via keypad



Option:
Bi-directional measurement. Blue or green arrows in the display indicate the direction of flow. A meter reading is available for each flow direction.



The sensor can be removed during operation and cleaned if necessary.



VA 500- Flow meter

Example order code VA 500:

0695 5001_B1_C1_D1_E1_F1_H1_J1_K1_L1_M1_N1_O1_P1_R1_Y1

Measuring range (see table page 114 to 117)

B1	Standard version (92,7 m/s)
B2	Max version (185 m/s)
B3	High-Speed version (224 m/s)
B4	Low-Speed version (50 m/s)

Screw-in thread

C1	G 1/2" male thread
C2	1/2" NPT male thread
C3	PT 1/2" male thread

Installation length / shaft length

D1	220 mm
D2	120 mm
D3	160 mm
D4	300 mm
D5	400 mm
D6	500 mm
D7	600 mm
D8	700 mm

Display option

E1	with integrated display
E2	without display

Signal outputs / bus connection option

F8	M-Bus, 1 x 4...20 mA analogue output (not electrically isolated), RS 485 (Modbus-RTU)
F9	1 x 4...20 mA analogue output (not electrically isolated), pulse output, RS 485 (Modbus-RTU)
F10	Ethernet interface (Modbus / TCP), 1 x 4...20 mA analogue output (not electrically isolated), RS 485 (Modbus-RTU)
F11	Ethernet interface PoE (Power over Ethernet) (Modbus / TCP), 1 x 4...20 mA analogue output (not electrically isolated), RS 485 (Modbus-RTU)

Surface condition

H1	standard version
H2	special cleaning - oil and grease free (e.g. for oxygen applications and so on)
H3	Silicone-free version including special cleaning oil- and grease-free

Adjustment / calibration

J1	No real gas adjustment - gas type configuration per gas constant
J2	Real gas adjustment in the gas type selected below

Gas type

K1	Compressed air
K2	Nitrogen (N2)
K3	Argon (Ar)
K4	Carbon dioxide (CO2)
K5	Oxygen (O2)
K6	Nitrous oxide (N2O)
K7	Natural gas (NG)
K8	Helium (He) (real gas adjustment J2 required)
K9	Propane (C3H8) (real gas adjustment J2 required)
K10	Methane (CH4)
K12	Further gas / please indicate gas type (on request)
K13	Gas mixture / please indicate mixture ratio (on request)

Reference standard

L1	20 °C, 1000 mbar
L2	0 °C, 1013,25 mbar
L3	15 °C, 981 mbar
L4	15 °C, 1013,25 mbar

Accuracy class

M1	± 1.5% of the measured value ± 0.3% f.s. (standard)
M2	± 1% of the measured value ± 0.3% f.s. (precision)

Approvals

N1	Non-explosive area - no approval
----	----------------------------------

Bi-directional measurement

O1	without
O2	with (includes 2 x 4...20 mA analog outputs and 2x pulse outputs. These are omitted for Ethernet (PoE) and M-Bus).

Maximum pressure (more than 10 bar high-pressure protection required!)

P1	50 bar
P2	16 bar

Special measuring range

R1	Special measuring range (please specify when placing order)
----	---

Option pressure measurement (only with: D1, D4, K1, K2, K3, H1, O1, P2)

Y1	without pressure sensor
Y2	with integrated pressure sensor 0...16 bar(g) (Output only via digital interfaces)
Y3	with integrated pressure sensor 10...2000 mbar (abs), for vacuum applications (output only via digital interfaces)

DESCRIPTION	ORDER NO.
High-pressure protection recommended for installation from 10 to 50 bar (for VA 400/500)	See page 105
ISO calibration certificate (5 calibration points) for VA sensors	3200 0001
Additional calibration curve stored in the sensor	Z695 5011
Certificate of origin	Z695 5012

For further accessories refer to pages 106 to 110

Simple installation and removal under pressure

1) Even under pressure, the flow probe VA 500 is mounted by means of a standard 1/2" ball valve.

During mounting and dismantling the safety ring avoids an uncontrolled ejection of the probe which may be caused by the operating pressure.

For the mounting into different pipe diameters, VA 500 is available in the following probe lengths: 120, 160, 220, 300, 400 mm.

The flow probes are therefore suitable for being mounted into existing pipes with diameters of 1/2" to DN 300 upwards.

The exact positioning of the sensor in the middle of the pipe is granted by means of the engraved depth scale.

The maximum mounting depth corresponds to the respective probe length. (Probe length 220 mm = 220 mm maximum mounting depth).

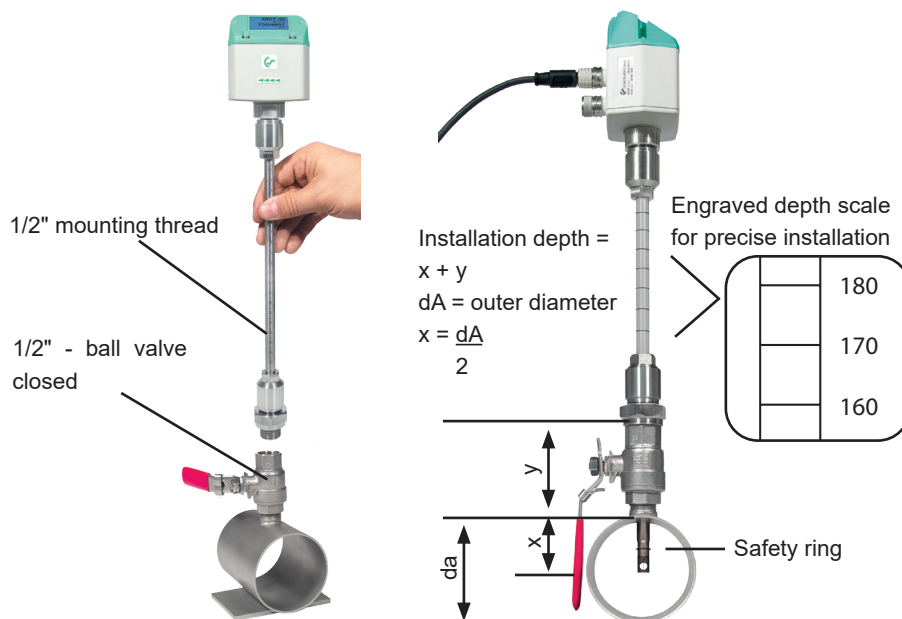

2) If there is no suitable measuring site with 1/2" ball valve, there are two easy ways to set up a measuring site:

A Weld on a 1/2" screw neck and screw on a 1/2" ball valve

B Mount spot drilling collar incl. ball valve (see accessories).

By means of the drilling jig, it is possible to drill under pressure through the 1/2" ball valve into the existing pipe. The drilling chips are collected in a filter. Then install the probe as described under 1).



A Screw neck



B Spot drilling collars



Drill under pressure with the CS drilling jig

3) Due to the large measuring range of the probe even extreme requirements to the consumption measurement (high volume flow in small pipe diameters) can be met.

The measuring range is depending on the pipe diameter - see table on the right hand side.

Flow measuring ranges VA 500 for compressed air (ISO 1217: 1000 mbar, 20 °C) Measuring ranges for other types of gas see pages 114 to 117								
Inside diameter of pipe			VA 500 Standard (92.7 m/s)		VA 500 Max. (185.0 m/s)		VA 500 High-Speed (224.0 m/s)	
Inch	mm		Measuring range full scale		Measuring range full scale		Measuring range full scale	
			m³/h	(cfm)	m³/h	(cfm)	m³/h	(cfm)
1/2"	16.1	DN 15	759 l/min	26	1516 l/min	53	1836 l/min	64
3/4"	21.7	DN 20	89 m³/h	52	177 m³/h	104	215 m³/h	126
1"	27.3	DN 25	148 m³/h	86	294 m³/h	173	356 m³/h	210
1 1/4"	36.0	DN 32	266 m³/h	156	531 m³/h	312	643 m³/h	378
1 1/2"	41.9	DN 40	366 m³/h	215	732 m³/h	430	886 m³/h	521
2"	53.1	DN 50	600 m³/h	353	1197 m³/h	704	1450 m³/h	853
2 1/2"	68.9	DN 65	1028 m³/h	604	2051 m³/h	1207	2484 m³/h	1461
3"	80.9	DN 80	1424 m³/h	838	2842 m³/h	1672	3441 m³/h	2025
4"	110.0	DN 100	2644 m³/h	1556	5278 m³/h	3106	6391 m³/h	3761
5"	133.7	DN 125	3912 m³/h	2302	7808 m³/h	4594	9453 m³/h	5563
6"	159.3	DN 150	5560 m³/h	3272	11096 m³/h	6530	13436 m³/h	7907
8"	200.0	DN 200	8785 m³/h	5170	17533 m³/h	10318	21229 m³/h	12493
10"	250.0	DN 250	13744 m³/h	8088	27428 m³/h	16141	33211 m³/h	19544
12"	300.0	DN 300	19814 m³/h	11661	39544 m³/h	23271	47880 m³/h	28177



Notes

VA 520 - Inline flow meter

Modbus-RTU output

4...20 mA output for present flow

Pulse output for total flow (counter reading), galvanically isolated or M-Bus (optionally)

NEW: As option, integrated pressure sensor

Measuring unit can be unscrewed: Removal of the entire measuring section not necessary, no by-pass necessary

Display head rotatable by 180 ° e.g. in case of reverse flow direction

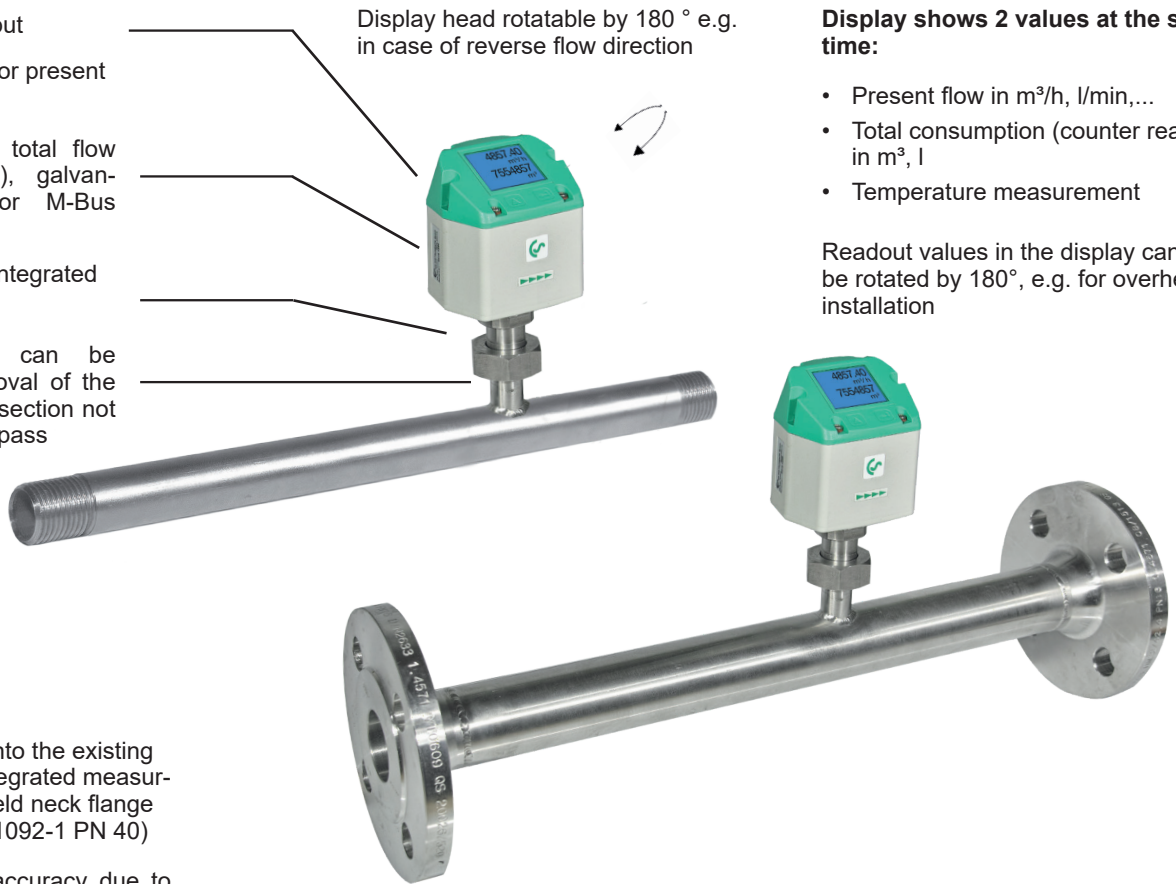

Display shows 2 values at the same time:

- Present flow in m³/h, l/min,...
- Total consumption (counter reading) in m³, l
- Temperature measurement

Readout values in the display can be rotated by 180°, e.g. for overhead installation

Easy installation into the existing pipeline due to integrated measuring section and weld neck flange (according to EN 1092-1 PN 40)

High measuring accuracy due to defined measuring section (inlet and outlet section)



The sensor can be removed and cleaned



With a key stroke:

- Reset counter reading
- Select units
- Zero-point adjustment, leak flow volume suppression

Option:

Bi-directional measurement. Blue or green arrows in the display indicate the direction of flow. A meter reading is available for each flow direction.

Application-technological features of the flow meters VA 520:

- Digital interfaces such as Modbus-RTU, Ethernet (PoE) and M-Bus enable connection to higher-level systems such as energy management systems, building management systems, PLC,...
- Easy and affordable installation
- Units freely selectable via keys on the display m³/h, m³/min, l/min, l/s, kg/h, kg/min, kg/s, cfm
- Compressed air counter up to 1,999,999,999 m³ can be reset to “zero” via keypad
- Analog output 4...20 mA, pulse output (electrically isolated)
- High measuring accuracy even in the lower measuring range (ideal for leakage measurement)
- Negligibly small loss of pressure
- Calorimetric measuring principle, no additional pressure and temperature measurement necessary, no mechanically moved parts
- Comprehensive diagnostic functions can be read out on the display or remote access via Modbus-RTU such as exceeding max./min values °C, calibration cycle, error codes, serial number. All parameters can be read out and changed via Modbus

Measuring range - Flow VA 520

		1/4"	3/8"	1/2"	3/4"	1"	1 1/4"	1 1/2"	2"	2 1/2"	3"
		l/min (cfm)	m³/h (cfm)	m³/h (cfm)	m³/h (cfm)	m³/h (cfm)	m³/h (cfm)	m³/h (cfm)	m³/h (cfm)	m³/h (cfm)	m³/h (cfm)
Referenzbedingungen DIN 1945 / ISO 1217: 20 °C, 1000 mbar											
Air	Low-Speed (50 m/s)	25 (0,9)	225 NI/min (8)	20 (14)	45 (25)	75 (45)	140 (80)	195 (115)	320 (190)	550 (325)	765 (450)
	Standard (92,7 m/s)	50 (1,8)	25 (14,7)	45 (25)	85 (50)	145 (85)	265 (155)	365 (215)	600 (350)	1025 (600)	1420 (835)
	Max (185 m/s)	105 (3,6)	50 (29,4)	90 (50)	175 (100)	290 (170)	530 (310)	730 (430)	1195 (700)	2050 (1205)	2840 (1670)
	High-Speed (224 m/s)	130 (4,5)	60 (35,3)	110(60)	215 (125)	355 (210)	640 (375)	885 (520)	1450 (850)	2480 (1460)	3440 (2025)
Setting to DIN 1343: 0 °C, 1013.25 mbar											
Argon (Ar)	Low-Speed (50 m/s)	45 (1,5)	330 NI/min (11,7)	35 (20)	75 (40)	120 (70)	220 (130)	305 (180)	505 (295)	865 (510)	1200 (705)
	Standard (92,7 m/s)	85 (3)	35 (20,5)	70 (40)	135 (80)	230 (135)	415 (245)	570 (335)	935 (550)	1605 (945)	2225 (1310)
	Max (185 m/s)	170 (6)	75 (44,1)	140 (80)	275 (160)	460 (270)	830 (485)	1140 (670)	1870 (1100)	3205 (1885)	4440 (2615)
	High-Speed (224 m/s)	205 (7,2)	95 (55,9)	170 (100)	335 (195)	555 (325)	1005 (590)	1385 (815)	2265 (1330)	3880 (2285)	5380 (3165)
Carbondi-oxide (CO2)	Low-Speed (50 m/s)	25 (0,9)	225 NI/min (7,9)	20 (14)	45 (25)	75 (45)	140 (80)	195 (115)	320 (185)	545 (320)	760 (445)
	Standard (92,7 m/s)	50 (1,8)	25 (14,7)	45 (25)	85 (50)	145 (85)	260 (155)	360 (210)	590 (345)	1015 (595)	1405 (825)
	Max (185 m/s)	105 (3,6)	50 (29,4)	90 (50)	175 (100)	290 (170)	525 (305)	720 (425)	1185 (695)	2030 (1190)	2810 (1655)
	High-Speed (224 m/s)	130 (4,5)	60 (35,3)	105 (60)	210 (125)	350 (205)	635 (370)	875 (515)	1430 (840)	2455 (1445)	3405 (2000)
Nitrogen (N2)	Low-Speed (50 m/s)	25 (0,9)	205 NI/min (7,2)	20 (13)	40 (25)	70 (40)	130 (75)	180 (105)	295 (175)	505 (300)	705 (415)
	Standard (92,7 m/s)	50 (1,5)	20 (11,7)	40 (20)	80 (45)	135 (75)	240 (140)	335 (195)	550 (320)	945 (555)	1305 (770)
	Max (185 m/s)	100 (3,3)	45 (26,4)	80 (45)	160 (95)	270 (155)	485 (285)	670 (395)	1100 (645)	1885 (1110)	2610 (1535)
	High-Speed (224 m/s)	120 (4,2)	55 (32,3)	100 (55)	195 (115)	325 (190)	590 (345)	815 (475)	1330 (780)	2280 (1340)	3165 (1860)
Oxygen (O2)	Low-Speed (50 m/s)	25 (0,9)	215 NI/min (7,5)	20 (13)	45 (25)	75 (40)	135 (80)	185 (110)	305 (180)	525 (310)	730 (430)
	Standard (92,7 m/s)	50 (1,8)	20 (11,7)	40 (25)	80 (45)	140 (80)	250 (145)	345 (205)	570 (335)	980 (575)	1355 (795)
	Max (185 m/s)	100 (3,6)	45 (26,4)	85 (50)	165 (95)	280 (165)	505 (295)	695 (410)	1140 (670)	1955 (1150)	2710 (1590)
	High-Speed (224 m/s)	125 (4,2)	55 (32,3)	105 (60)	205 (120)	340 (200)	610 (360)	845 (495)	1380 (810)	2365 (1390)	3280 (1930)
Nitrous oxide (N2O)	Low-Speed (50 m/s)	25 (0,9)	220 NI/min (7,7)	20 (14)	45 (25)	75 (45)	140 (80)	190 (110)	315 (185)	540 (320)	750 (440)
	Standard (92,7 m/s)	50 (1,8)	20 (11,7)	40 (25)	85 (50)	140 (85)	260 (150)	355 (210)	585 (345)	1005 (590)	1395 (820)
	Max (185 m/s)	105 (3,6)	45 (26,4)	85 (50)	170 (100)	285 (170)	520 (305)	715 (420)	1170 (690)	2010 (1180)	2785 (1640)
	High-Speed (224 m/s)	125 (4,5)	60 (35,3)	105 (60)	210 (120)	345 (205)	630 (370)	865 (510)	1420 (835)	2435 (1430)	3375 (1985)
Natural gas (NG)	Low-Speed (50 m/s)	15 (0,6)	130 NI/min (4,5)	14,4 (8)	25 (15)	45 (25)	85 (50)	115 (65)	190 (110)	325 (190)	450 (265)
	Standard (92,7 m/s)	30 (0,9)	14 (8,8)	25 (15)	50 (30)	85 (50)	155 (90)	215 (125)	355 (205)	605 (355)	840 (495)
	Max (185 m/s)	60 (2,1)	25 (14,7)	50 (30)	105 (60)	170 (100)	310 (185)	430 (250)	705 (415)	1210 (710)	1680 (985)
	High-Speed (224 m/s)	75 (2,7)	35 (20,5)	65 (35)	125 (70)	210 (120)	380 (220)	520 (305)	855 (500)	1465 (865)	2035 (1195)



Optional: Connection to different Bus systems

There are different options available for connection to modern Bus systems:

- Ethernet interface (Modbus-TCP) / PoE
- M-BUS
- Modbus-RTU



Ethernet Modbus TCP

M12 Ethernet port, x-coded

VA 520 - Inline flow meter

Example order code VA 520:

0695 xxxx_B1_C1_E1_F1_G1_H1_K1_L1_M1_N1_O1_R1_Y1

Measuring range (see table 114-117)	
B1	Max version (185 m/s)
B2	Low-speed version (50 m/s)
B3	Standard version (92,7 m/s)
B4	High-speed version (224 m/s)

Male thread measuring section	
C1	R male thread
C2	NPT male thread (only in 1.4404)
C3	Flange DIN EN 1092-1
C4	Flange ANSI 16.5 Class 150 lbs
C5	Flange ANSI 16.5 Class 300 lbs

Option signal outputs / bus connection	
E1	1 x 4...20 mA analogue output (not electrically isolated), pulse output, RS 485 (Modbus-RTU)
E2	M-Bus, 1 x 4...20 mA analogue output (not electrically isolated), RS 485 (Modbus-RTU)
E4	Ethernet interface (Modbus / TCP), 1 x 4...20 mA analogue output (not electrically isolated), RS 485 (Modbus-RTU)
E5	Ethernet interface PoE (Power over Ethernet) (Modbus/TCP), 1 x 4...20 mA analogue output (not electrically isolated), RS 485 (Modbus-RTU)

Adjustment/calibration	
F1	No real gas adjustment - gas type configuration per gas constant
F2	Real gas adjustment in the gas type selected below

Gas type	
G1	Compressed air
G2	Nitrogen (N2)
G3	Argon (Ar)
G4	Carbon dioxide (CO2)
G5	Oxygen (O2)
G6	Nitrous oxide (N2O)
G7	Natural gas (NG)
G8	Helium (He) (real gas adjustment F2 required)
G9	Propane (C3H8) (real gas adjustment F2 required)
G10	Methane (CH4)
G12	Further gas / please indicate gas type (on request)
G13	Gas mixture / please indicate mixture ratio (on request)

Reference standard	
H1	20 °C, 1000 mbar
H2	0 °C, 1013.25 mbar
H3	15 °C, 981 mbar
H4	15 °C, 1013.25 mbar

Maximum pressure	
K1	16 bar
K2	40 bar

Surface condition	
L1	standard version
L2	Special cleaning - oil and grease free (e. g. for oxygen applications and so on)
L3	Silicone-free version including special cleaning oil- and grease-free

Accuracy class	
M1	± 1.5% of the measured value ± 0.3% f.s. (standard)
M2	± 1% of the measured value ± 0.3% f.s. (precision)

Approvals	
N1	Non-explosive area - no approval
N3	DVGW approval for natural gas (max. pressure 16 bar)

Bi-directional measurement	
O1	without
O2	with (2 units 4...20 mA analogue output, pulse output These are omitted for Ethernet (PoE and M-Bus))

Special measuring range	
R1	Special measuring range (please specify when placing order)

Option pressure measurement (only with: G1, G2, G3, K1, L1, N1, O1)	
Y1	without pressure sensor
Y2	with integrated pressure sensor 0...16 bar(g) (Output only via digital interfaces)
Y3	with integrated pressure sensor 10...2000 mbar (Output only via digital interfaces)

Order no. VA 520

DESCRIPTION (Flange version) / Stainless steel 1.4404	ORDER NO.
VA 520 flow meter with integrated DN 15 measuring section with flange	0695 2521
VA 520 flow meter with integrated DN 20 measuring section with flange	0695 2522
VA 520 flow meter with integrated DN 25 measuring section with flange	0695 2523
VA 520 flow meter with integrated DN 32 measuring section with flange	0695 2526
VA 520 flow meter with integrated DN 40 measuring section with flange	0695 2524
VA 520 flow meter with integrated DN 50 measuring section with flange	0695 2525
VA 520 flow meter with integrated DN 65 measuring section with flange	0695 2527
VA 520 flow meter with integrated DN 80 measuring section with flange	0695 2528

DESCRIPTION	ORDER NO.	ORDER NO.
	Stainless steel 1.4404	Stainless steel 1.4301
VA 520 flow meter with 1/4" measuring section	0695 1520	0695 0520
VA 520 flow meter with 3/8" measuring section	0695 1527	0695 0527
VA 520 flow meter with 1/2" measuring section	0695 1521	0695 0521
VA 520 flow meter with 3/4" measuring section	0695 1522	0695 0522
VA 520 flow meter with 1" measuring section	0695 1523	0695 0523
VA 520 flow meter with 1 1/4" measuring section	0695 1526	0695 0526
VA 520 flow meter with 1 1/2" measuring section	0695 1524	0695 0524
VA 520 flow meter with 2" measuring section	0695 1525	0695 0525

ACCESSORIES	ORDER NO.
ISO calibration certificate (5 calibration points) for VA sensors	3200 0001
Additional calibration curve stored in the sensor	Z695 5011
Certificate of origin	Z695 5012
Closing cap for measuring section in aluminium	0190 0001
Closing cap for measuring section stainless steel 1.4404	0190 0002
Connection cable for VA/FA series, 5 m	0553 0104
Connection cable for VA/FA sensors, 10 m	0553 0105
Ethernet connection cable length 5 m, M12 plug x-coded (8 pin) to RJ 45 plug	0553 2503
Ethernet connection cable length 10 m, M12 plug x-coded (8 pin) to RJ 45 plug	0553 2504

For further accessories refer to pages 106-110

TECHNICAL DATA VA 520

Parameters:	m ³ /h, l/min (1000 mbar, 20 °C) in case of compressed air or Nm ³ /h, NI/min (1013 mbar, 0 °C) in case of gases
Units adjustable via keys at display:	m ³ /h, m ³ /min, l/min, l/s, ft/min, cfm, m/s, kg/h, kg/min, g/s, lb/min, lb/h
Sensor:	Thermal mass flow sensor
Measured medium:	Air, gases
Gas types are adjustable over CS service software or CS data logger:	Air, nitrogen, argon, CO ₂ , oxygen
Measuring range:	See table above
Accuracy: (o. M. V. = of measured value) (o. F. S. = of full scale)	± 1.5% of m.v. ± 0.3% of f.s. on request: ± 1% of m.v. ± 0.3% of f.s.
Operating temperature:	-30...80 °C -20...80 °C with pressure sensor
Operating pressure:	-1 to 16 bar optionally up to PN 40
Digital output:	RS 485 interface, (Modbus-RTU), optional: Ethernet interface PoE), M-Bus
Analogue output:	4...20 mA for m ³ /h or l/min
Pulse output:	1 pulse per m ³ or per litre electrically isolated. Pulse weight can be set on the display. Alternatively, the pulse output can be used as an alarm relay
Supply:	18...36 VDC, 5 W
Burden:	< 500 Ω
Housing:	Polycarbonate (IP 65)
Measuring section:	Stainless steel, 1.4404 or 1.4301
Mounting position:	any

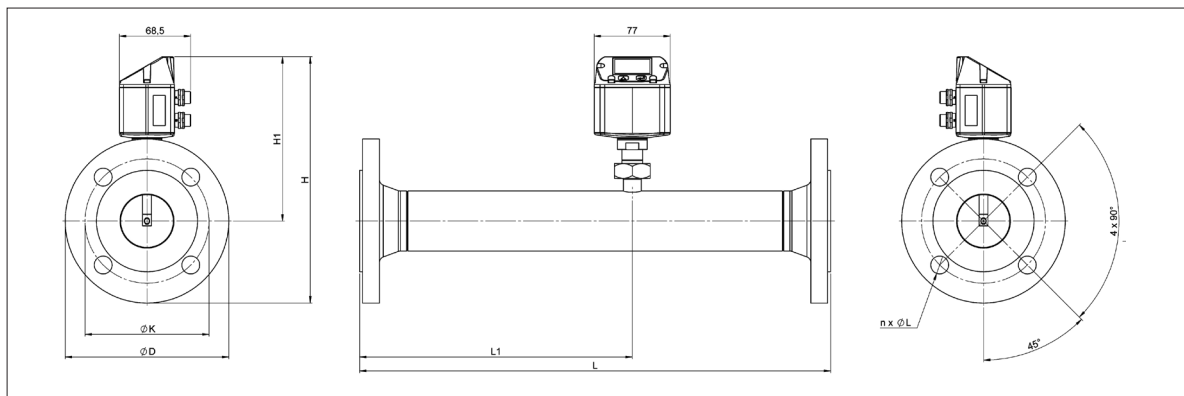

VA 520 - Flange							Flange DIN EN 1092-1		
Measuring section	Outer pipe	Inner pipe	L	L1	H	H1	ØD	ØK	n x ØL
	mm	mm	mm	mm	mm	mm	mm	mm	
DN 15	21.3	16.1	300	210	213.2	165.7	95	65	4 x 14
DN 20	26.9	21.7	475*	275	218.2	165.7	105	75	4 x 14
DN 25	33.7	27.3	475*	275	223.2	165.7	115	85	4 x 14
DN 32	42.4	36.0	475*	275	235.7	165.7	140	100	4 x 18
DN 40	48.3	41.9	475*	275	240.7	165.7	150	110	4 x 18
DN 50	60.3	53.1	475*	275	248.2	165.7	165	125	4 x 18
DN 65	76.1	68.9	475*	275	268.2	175.7	185	145	8 x 18
DN 80	88.9	80.9	475*	275	275.7	175.7	200	160	8 x 18

*Attention: Shortened inlet section. Please observe the recommended minimum inlet section (length = 15 x inner diameter) on site.

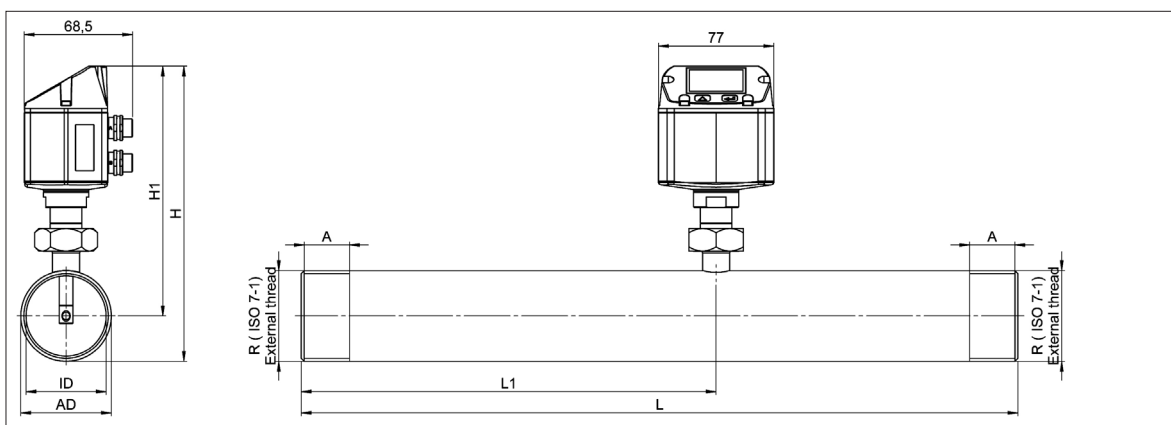

VA 520 - Thread							
Connection thread	Outer pipe	Inner pipe	L	L1	H	H1	A
	mm	mm	mm	mm	mm	mm	mm
R 1/4"	13.7	8.9	194	137	174.7	165.7	15
R 3/8"	17.2	12.5	300	200	175	165.7	15
R 1/2"	21.3	16.1	300*	210	176.4	165.7	20
R 3/4"	26.9	21.7	475*	275	179.2	165.7	20
R 1"	33.7	27.3	475*	275	182.6	165.7	25
R 1 1/4"	42.4	36.0	475*	275	186.9	165.7	25
R 1 1/2"	48.3	41.9	475*	275	186.9	165.7	25
R 2"	60.3	53.1	475*	275	195.9	165.7	30

*Attention: Shortened inlet section. Please observe the recommended minimum inlet section (length = 15 x inner diameter) on site!



Notes

VA 521 - Compact inline flow sensor for compressed air and other types of gas

No inlet section necessary – integrated flow straightener – sensor unit removable

The newly developed VA 521 combines modern digital interfaces for connection to energy monitoring systems with a small, compact design. The VA 521 is always used when many machines (compressed air consumers) are to be integrated into an energy monitoring network.



Readout values in the display can be rotated by 180°, e.g. for overhead installation

Display shows 2 values at the same time:

- Present flow in m³/h, l/min,...
- Total consumption (counter reading) in m³, l, kg
- Temperature measurement

Screw-in thread:

Easy installation into the existing pipe due to integrated measuring section (suitable for 1/2", 3/4", 1", 1 1/4", 1 1/2" or 2" lines)

Advantages at a glance:

- Compact, small design - for use in machines, behind maintenance unit on the end user
- All interfaces are freely programmable via the display
- Modbus-RTU output
- 4...20 mA analogue output for present flow
- Pulse output total flow (counter reading), electrically isolated. Optional: M-Bus, Ethernet interface or PoE
- **NEW:** As option, integrated pressure sensor

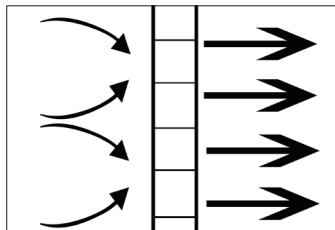

Integrated flow straightener - no inlet section necessary



With a key stroke:

- Reset counter reading
- Select units
- Parameterise interfaces



The sensor can be removed from the measuring section and cleaned.

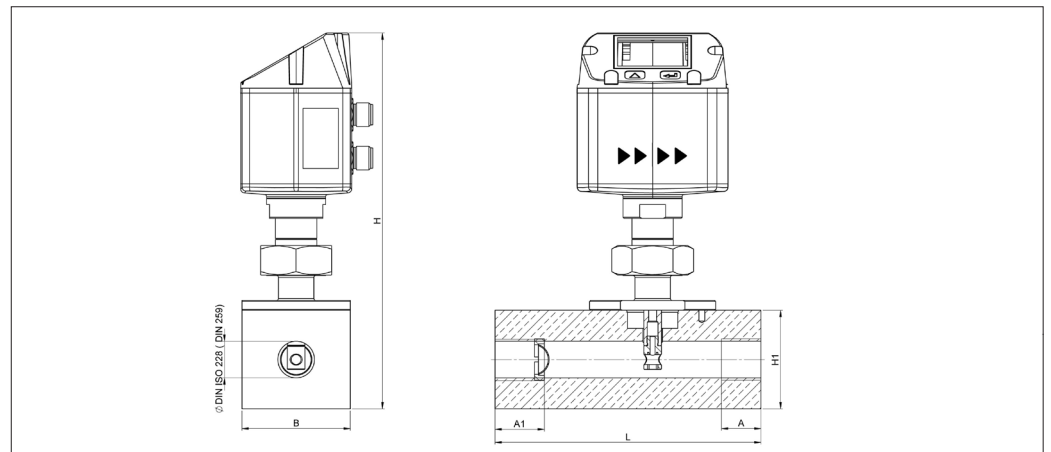

Flow measuring ranges VA 521 (max version 185 m/s) for compressed air (ISO 1217: 1000 mbar, 20 °C) Measuring ranges for other types of gas see pages 118 to 121

Measuring section	Thread	Measuring range full scales		L	B	H1	H	A1	A
		m³/h	cfm						
DN 15	G 1/2"	90 m³/h	50	135	55	50	109.65	25	20
DN 20	G 3/4"	170 m³/h	100	135	55	50	109.65	26	20
DN 25	G 1"	290 m³/h	170	135	55	50	109.65	33	25
DN 32	G 1 1/4"	530 m³/h	310	135	80	80	215.45	35	25
DN 40	G 1 1/2"	730 m³/h	430	135	80	80	215.45	36	25
DN 50	G 2"	1195 m³/h	700	135	80	80	215.45	44	30

Example order code VA 521:

0696 0521_A1_B1_C1_D1_E1_F1_G1_H1_I1_J1_K1_L1_M1_R1

Measuring section	
A2	1/2"
A3	3/4"
A4	1"
A5	1 1/4"
A6	1 1/2"
A7	2"

Threaded version	
B1	G female thread
B2	NPT female thread

Material type	
C1	Aluminium
C2	Stainless steel 316L

Adjustment/calibration	
D1	No real gas adjustment - gas type configuration per gas constant
D2	Real gas adjustment in the gas type selected below

Gas type	
E1	Compressed air
E2	Nitrogen (N2)
E3	Argon (Ar)
E4	Carbon dioxide (CO2)
E5	Oxygen (O2)
E6	Nitrous oxide (N2O)
E7	Natural gas (NG)
E90	Further gas / please indicate gas type (on request)
E91	Gas mixture / please indicate mixture ratio (on request)

Measuring range (see table)	
F1	Low-speed version (50 m/s)
F2	Standard version (92,7 m/s)
F3	Max version (185 m/s)
F4	High-speed version (224 m/s)

Reference standard	
G1	20 °C, 1000 mbar
G2	0 °C, 1013.25 mbar
G3	15 °C, 981 mbar
G4	15 °C, 1013.25 mbar

Display option	
H1	With integrated display
H2	Without display

Pressure measurement option (only with: E1, E2, E3, M1, N1, P1)	
I1	Without pressure sensor
I2	with integrated pressure sensor 0...16 bar(g) (Output only via digital interfaces)
I3	with integrated pressure sensor 10...2000 mbar (Output only via digital interfaces)

Signal / bus connection option	
J1	1 x 4...20 mA analogue output (not electrically isolated), pulse output, RS 485 (Modbus-RTU)
J2	Ethernet interface (Modbus / TCP), 1 x 4...20 mA analogue output (not electrically isolated, RS), 485 (Modbus-RTU)
J3	Ethernet interface PoE (Modbus / TCP), 1 x 4...20 mA analogue output (not electrically isolated), RS 485 (Modbus-RTU)
J4	M-Bus, 1 x 4...20 mA analogue output (not electrically isolated), RS 485 (Modbus-RTU)

Flow straightener	
K1	With integrated flow straightener, no additional inlet section necessary (with measuring section 1/2" to 2")

Accuracy class	
L1	± 1.5% of m.v. ± 0.3% of f.s.
L2	± 1% of m.v. ± 0.3% of f.s.

Maximum pressure	
M1	16 bar
M2	40 bar (Not available with NPT thread >1")

Surface condition	
N1	Standard version
N2	Special cleaning oil and grease free (e. g. for oxygen applications and so on)
N3	Silicone-free version including special cleaning oil and grease-free

Approvals:	
O1	No approval
O2	DVGW approval for natural gas (max. pressure 16 bar)

Special measuring range	
R1	Special measuring range (please specify when placing order)

Order no. VA 521

DESCRIPTION	ORDER NO.
Compact inline flow meter	0696 0521 + Order code A...R_

For further accessories refer to pages 106 to 110

TECHNICAL DATA VA 521

Parameters:	m³/h, l/min (1000 mbar, 20 °C) in case of compressed air or Nm³/h, NI/min (1013 mbar, 0 °C) in case of gases
Units adjustable via keys at display:	m³/h, m³/min, l/min, l/s, ft/min, cfm, m/s, kg/h, kg/min, g/s, lb/min, lb/h
Sensor:	Thermal mass flow sensor
Measured medium:	Air, gases
Gas types are adjustable over CS service software or CS data logger:	Air, nitrogen, argon, CO2, oxygen
Measuring range:	See table
Accuracy: (o. M. V. = of measured value) (o. F. S. = of full scale)	± 1.5% of m.v. ± 0.3 % of f.s. on request: ± 1% of m.v. ± 0.3% of f.s.
Operating temperature:	-30...80 °C, -20...80 °C with pressure sensor
Operating pressure:	Up to 16 bar, optionally 40 bar
Digital output:	RS 485 interface, (Modbus-RTU), optional M-Bus, Ethernet interface or PoE
Analogue output:	4...20 mA for m³/h or l/min
Pulse output:	1 pulse per m³ or per litre electrically isolated. Pulse weight can be set on the display. Alternatively, the pulse output can be used as an alarm relay.
Supply:	18...36 VDC, 5 W
Burden:	< 500 Ω
Housing:	Polycarbonate (IP 65)
Measuring section:	Aluminium, 316L
Connection thread of measuring sections:	G 1/2" to G 2" (BSP British Standard Piping) or 1/2" to 2" NPT thread
Mounting position:	any

VA 525 - Compact inline flow sensor for air and nitrogen

No inlet section necessary – integrated flow straightener – optional pressure sensor

The newly developed VA 525 combines modern digital interfaces for connection to an energy monitoring system with a small, compact design. The VA 525 is always used when many machines (compressed air consumers) are to be integrated into an energy monitoring network.

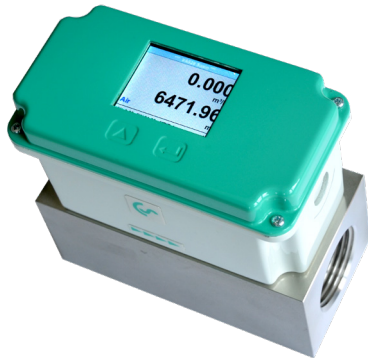

Readout values in the display can be rotated by 180°, e.g. for overhead installation

Display shows 2 values at the same time:

- Present flow in m³/h, l/min,...
- Total consumption (counter reading) in m³, l, kg
- Temperature measurement
- **Optional:** Pressure measurement

Advantages at a glance:

- Compact, small design - for use in machines, behind maintenance unit on the end user
- Optionally with conventional analogue signals (4...20 mA and pulse) or digital interfaces such as Modbus-RTU, Ethernet (also PoE), M-Bus
- All interfaces are freely programmable via the display

Screw-in thread:

Easy installation into the existing pipe due to integrated measuring section (suitable for 1/4", 1/2", 3/4", 1", 1 1/4", 1 1/2" or 2" lines)

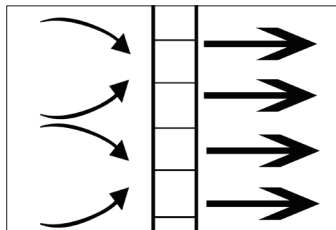

Integrated flow straightener - no inlet section necessary



With a key stroke:

- Reset counter reading
- Select units
- Parameterise interfaces

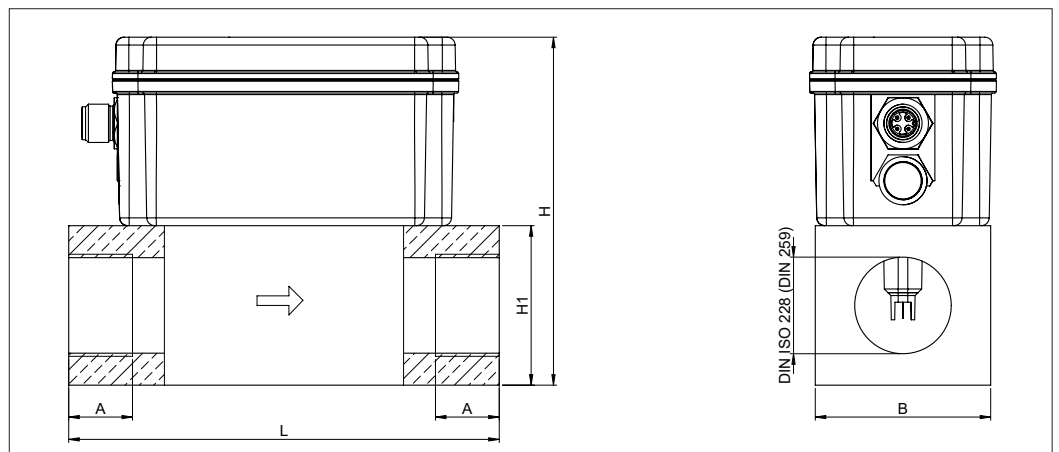

Flow measuring ranges VA 525 (max version 185 m/s) for compressed air (ISO 1217:1000 mbar, 20 °C) Measuring ranges for other types of gas see pages 118 to 121

Measuring section	Thread	Measuring range full scales		L mm	B mm	H1 mm	H mm	A mm
		m ³ /h	cfm					
DN 8	G 1/4"	105 l/min	3.6	135	55	50	109.1	15
DN 15	G 1/2"	90 m ³ /h	50	135	55	50	109.1	20
DN 20	G 3/4"	170 m ³ /h	100	135	55	50	109.1	20
DN 25	G 1"	290 m ³ /h	170	135	55	50	109.1	25
DN 32	G 1 1/4"	530 m ³ /h	310	135	80	80	139.1	25
DN 40	G 1 1/2"	730 m ³ /h	430	135	80	80	139.1	25
DN 50	G 2"	1195 m ³ /h	700	135	80	80	139.1	30

Example order code VA 525:

0695 5250_A1_B1_C1_D1_E1_F1_G1_H1_I1_J1_K1_L1_M1_R1

Measuring section	
A1	1/4"
A2	1/2"
A3	3/4"
A4	1"
A5	1 1/4"
A6	1 1/2"
A7	2"

Threaded version	
B1	G female thread
B2	NPT female thread

Material type	
C1	Aluminium

Adjustment/calibration	
D1	No real gas adjustment - gas type configuration per gas constant
D2	Real gas adjustment in the gas type selected below

Gas type	
E1	Compressed air
E2	Nitrogen (N2)

Measuring range (see table)	
F1	Low-speed version (50 m/s)
F2	Standard version (92,7 m/s)
F3	Max version (185 m/s)
F4	High-speed version (224 m/s)

Reference standard	
G1	20 °C, 1000 mbar
G2	0 °C, 1013.25 mbar
G3	15 °C, 981 mbar
G4	15 °C, 1013.25 mbar

Display option	
H1	With integrated display
H2	Without display

Pressure measurement option	
I1	Without pressure sensor
I2	With integrated pressure sensor 0...16 bar (output only via digital interfaces)
I3	With integrated pressure sensor 10...2000 mbar (abs), for vacuum applications (output only via digital interfaces)

Signal output / bus connection option	
J1	1x 4...20 mA analogue output for present flow and pulse output
J2	Modbus-RTU (RS485)
J3	Ethernet interface (Modbus/TCP)
J4	Ethernet interface Power over Ethernet (Modbus/TCP)
J5	M-Bus

Rectifier	
K1	With integrated flow straightener, no additional inlet section necessary (with measuring section 1/2" to 2")
K2	Without rectifier (for measuring section 1/4")

Accuracy class	
L1	± 1.5% of m.v. ± 0.3% of f.s.
L2	± 6% of m.v. ± 0.5% of f.s.
L3	± 1% of m.v. ± 0.3% of f.s.

Maximum pressure	
M1	16 bar

Surface condition	
N1	Standard version

Special measuring range	
R1	Special measuring range (please specify when placing order)

Order no. VA 525

DESCRIPTION	ORDER NO.
Compact inline flow meter	0695 5250 + Order code A_...R_

TECHNICAL DATA VA 525

Parameters:	m³/h, l/min (1000 mbar, 20 °C) in case of compressed air or Nm³/h, NI/min (1013 mbar, 0 °C) in case of gases
Units adjustable via keys at display:	m³/h, m³/min, l/min, l/s, ft/min, cfm, m/s, kg/h, kg/min, g/s, lb/min, lb/h
Sensor:	Thermal mass flow sensor
Measured medium:	Air
Measuring range:	See table above
Accuracy: (o. M. V. = of measured value) (o. F. S. = of full scale)	± 1.5% of m.v. ± 0.3 % of f.s. on request: ± 1% of m.v. ± 0.3% of f.s. or ± 6% of m.v. ± 0.5% of f.s.
Pressure measurement:	0...16 bar, accuracy: 1%, or 10...2000 mbar (abs)
Operating temperature:	-20...60 °C
Operating pressure:	Up to 16 bar
Digital output:	RS 485 interface, (Modbus-RTU), M-Bus (optional) Ethernet interface or PoE
Analogue output:	4...20 mA for m³/h or l/min
Pulse output:	1 pulse per m³ or per litre electrically isolated. Pulse weight can be set on the display. Alternatively, the pulse output can be used as an alarm relay.
Supply:	18...36 VDC, 5 W
Burden:	< 500 Ω
Housing:	Polycarbonate (IP 65)
Measuring section:	Aluminium
Connection thread of measuring sections:	G 1/4" to G 2" (BSP British Standard Piping) or 1/2" to 2" NPT thread
Mounting position:	any

VD 500 - Flow sensor for wet compressed air

For measuring immediately downstream of the compressor in moist air up to +180 °C

FIELD OF APPLICATION:

- Measurement immediately downstream of the compressor
- Measurement at high temperatures



Benefits at a glance:

- **New:** Unique sensitivity in the lower measuring range: Measures from as little as 2 m/s and thus covers the complete operating range of variable speed drive (VSD) compressors
- Particularly suitable for extremely high flow rates
- Flow, total consumption, temperature and pressure
- Measurement at high temperatures, max. temperature 180 °C
- Can be used in pipes from DN 20 to DN 600
- Installation via 1/2" ball valve under pressure

Typical applications:

- Measurement of the capacity of compressors
- Compressed air audits
- Efficiency measurement of compressed air systems

Installation requirements:

- After functioning water separator
- In horizontal lines (recommended) or in risers

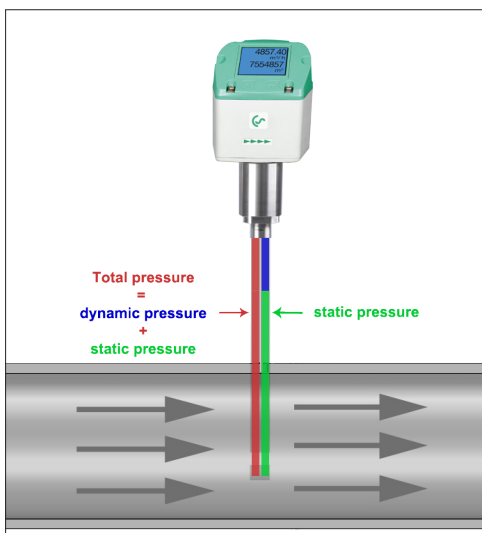

The integrated, precise differential pressure sensor measures the differential pressure/dynamic pressure at the sensor tip. The pressure depends on the respective gas velocity. The flow is therefore easy to determine by means of the pipe diameter.

The additional measurement of temperature and absolute pressure and calculation of the relevant density means that measuring can be carried out for various gases, a wide variety of temperatures and pressures.

TECHNICAL DATA VD 500

Measuring range:	2 up to 224 m/s / 600 m/s
Measured medium:	Air, non-aggressive gases
Accuracy: (m.v.: of meas. value) (f.s.: of full scale)	± 1.5% of m.v. ± 0.3% of f.s. ± 1.5% of m.v. (> 224 m/s)
Measuring principle:	Differential pressure
Measuring span:	1:100
Response time:	t ₉₉ : < 1 sec.
Temperature of the medium:	-30 °...+180 °C
Operating pressure:	Max. 30 bar
Ambient temperature:	-30 °...+70 °C
Power supply:	18...36 VDC, 5 W
Signal outputs:	As standard: RS 485 (Modbus-RTU), 4...20 mA, pulse Optional: Ethernet Interface (PoE), M-Bus

Example order code VD 500:

0690 5001_A1_B1_C1_D1_E1_G1_K1

Measuring range	
A1	224 m/s
A2	600 m/s
Screw-in thread	
B1	G 1/2"
B2	1/2" NPT male thread
B3	PT 1/2"
Installation length / shaft length	
C1	220 mm
C2	400 mm
Display	
D1	with integrated display
Signal outputs / bus connection option	
E1	1x 4...20 mA analogue output (electrically not isolated), pulse output, RS 485 (Modbus-RTU)
E2	Ethernet interface (Modbus/TCP), 1 x 4...20 mA analogue output (not electrically isolated), RS 485 (Modbus-RTU)
E3	Ethernet interface PoE (Power over Ethernet) (Modbus/TCP), 1 x 4...20 mA analogue output (not electrically isolated), RS 485 (Modbus-RTU)
E4	M-Bus, 1 x 4...20 mA analogue output (not electrically isolated), RS 485 (Modbus-RTU)
Reference standard	
G1	20 °C, 1000 mbar
G2	0 °C, 1013.25 mbar
G3	15 °C, 981 mbar
G4	15 °C, 1013.25 mbar
Gas type	
K1	Compressed air
K90	Additional gas on request

Simple installation and removal under pressure

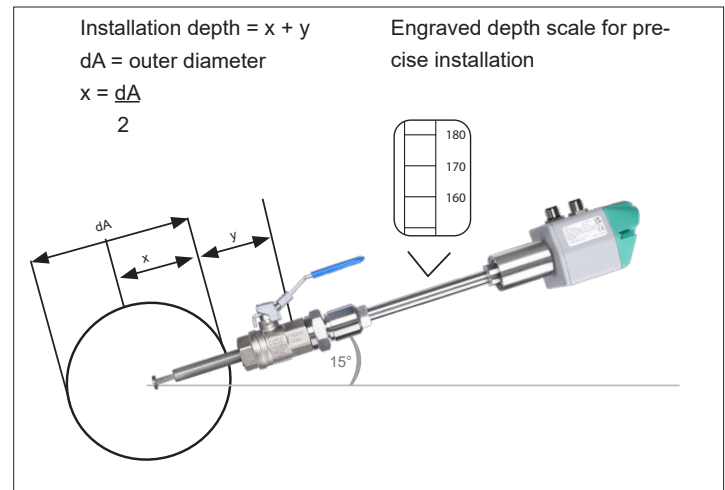

Recommended installation position

DESCRIPTION	ORDER NO.
VD 500 flow sensor for wet compressed air	0690 5001 + Order code A_...K_
Accessories:	
ISO calibration certificate	3200 0001
High-pressure protection	0530 2205
Configuration see page 103	

Flow measuring ranges VD 500 for compressed air (ISO 1217:1000 mbar, 20 °C)				
Inside diameter of pipe			VD 500 2 ... 224 m/s	
			Measuring range initial values and full scale	
Inch	mm	DN	m³/h	cfm
3/4"	21,7	DN 20	2 ... 215	1.2 ... 127
1"	27,3	DN 25	3,2 ... 357	1.9 ... 210
1 1/4"	36,0	DN 32	5,7 ... 644	3.4 ... 379
1 1/2"	41,9	DN 40	8 ... 886	4.7... 522
2"	53,1	DN 50	13 ... 1450	8 ... 853
2 1/2"	68,9	DN 65	23 ... 2484	13 ... 1462
3"	80,9	DN 80	31 ... 3440	18 ... 2025
4"	110,0	DN 100	57 ... 6391	34 ... 3762
5"	133,7	DN 125	85 ... 9453	50 ... 5564
6"	159,3	DN 150	120 ... 13436	71 ... 7908
8"	200,0	DN 200	190 ... 21230	112 ... 12495
10"	250,0	DN 250	296 ... 33211	175 ... 19547
12"	300,0	DN 300	428 ... 47881	252 ... 28182



VU 570 - Vortex ultrasonic flow sensor for technical gases and mixed gases

Independent from gas composition – integrated pressure and temperature compensation
– larger measuring range than common Vortex sensors

FIELD OF APPLICATION:

- Technical gases
- Mixed gases
- Compressed air in PET bottles production
- LPG
- Propane
- Crypton



Function principle Vortex ultrasonic:

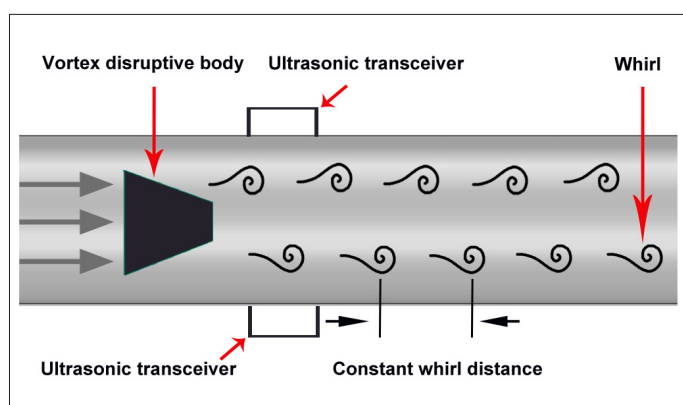

Benefits at a glance:

- Measurement of standard volume flow, operating volume flow, mass flow
- Suitable for unknown/changing gas compositions and mixed gases
- The innovative measuring principle grant a precise flow measurement in different gases
- Suitable for quickly changing temperature and pressure changes as well as high mass flows

Advantages towards common mechanic gas meters:

- No moving parts – no wearing

Advantages towards common Vortex sensors:

- Precise measurement already from 0.3 m/s



Example order code VU 570:

0697 0570_A1_B1_C1_D1_E1_F1_G1_H1

Measuring section	
A1	1/2" (DN 15)
A2	3/4" (DN 20)
A3	1" (DN 25)
A4	1 1/4" (DN 32)
A5	1 1/2" (DN 40)
A6	2" (DN 50)
A7	2 1/2" (DN 65), (only in flanged version)
A8	3" (DN 80), (only in flanged version)

Process connection	
B1	R outer threads
B2	NPT outer threads
B3	Flange DIN 1092-1
B4	Flange ANSI 16.5 Class 150 lbs
B5	Flange ANSI 16.5 Class 300 lbs

Option display	
C1	With integrated display
C2	Without display

Pressure sensor	
D1	16 bar (g)
D2	40 bar (g)
D3	1.5 bar (g)

Signal outputs / bus connection option	
E1	2 x 4...20 mA analogue output (galv. isolated), pulse output, RS 485 (Modbus-RTU)
E4	1 x 4...20 mA analogue output (galv. not isolated), pulse output RS 485 (Modbus-RTU)
E5	Ethernet-Interface (Modbus/TCP), 1 x 4...20 mA analogue output (galv. not isolated), pulse output, RS 485 (Modbus-RTU)
E8	M-Bus, 1 x 4...20 mA analogue output (galv. not isolated), pulse output RS 485 (Modbus-RTU)
E9	Ethernet-Interface PoE (Power over Ethernet) Modbus/TCP, 1 x 4...20 mA analogue output (galv. not isolated), pulse output, RS 485 (Modbus-RTU)

Calibration	
F1	No real gas calibration - Adjustment of gas type via gas constant
F2	Real gas calibration in selected gas type

Reference conditions	
G1	20 °C, 1000 mbar
G2	0 °C, 1013,25 mbar
G3	15 °C, 981 mbar
G4	15 °C, 1013,25 mbar
G5	Operation conditions

Accuracy class	
H1	± 1,5% of measured value (volume flow)
H2	± 1% of measured value (volume flow)

TECHNICAL DATA VU 570

Measuring range:	See table
Measuring medium:	Air, non-aggressive gases and mixed gases (non-condensing)
Accuracy:	± 1,5 % m. v., optional
Volume flow (m³/h)	± 1 % m. v.
Mass flow (kg/h) resp. Standard volume flow (Nm³/h)	± 2 % m. v., optional ± 1,5 % m. v.
Meas. principle:	Vortex ultrasonic – Vortex frequency measurement
Process temp.:	-40° ... +100°C
Process pressure:	Up to 40 bar (ü)
Protection class:	IP67
Material meas. Section and medium-touching parts:	Stainless steel 316, Plastic
Material display unit:	Aluminium - Die casting
Signal outputs:	As a standard: RS 485 (Modbus-RTU), 1x 4...20 mA, puls Optional: Ethernet Interface
Power supply :	18...36 VDC
Measuring span:	1:50
Repeatability:	± 0,3 % v. M.
Process connection:	Flange DIN EN1092-1 or Flange ANSI 150 lbs - 300 lbs R 1/2" - R 2" (BSP British Standard Piping) 1/2" - 2" NPT-thread

DESCRIPTION	ORDER NO.
VU 570 - Vortex ultrasonic flow sensor for technical gases and mixed gases	0697 0570+ Order code A...H_
Further accessories: ISO - calibration certificate at 5 measuring points	3200 0001

Measuring ranges for gases VU 570 under operation conditions

Inch	mm	DN	from	m/s	to	from	m³/h	to	from	cfm	to
1/2"	16,1	15	0,5	30		0,4	22,0		0,2	12,9	
3/4"	21,7	20				0,7	39,9		0,4	23,5	
1"	27,3	25				0,6	63,2		0,4	37,2	
1 1/4"	36	32	0,3	30		1,1	109,9		0,6	64,7	
1 1/2"	41,9	40				1,5	148,9		0,9	87,6	
2"	53,1	50				2,4	239,2		1,4	140,8	
2 1/2"	68,9	65				4,0	402,7		2,4	237,0	
3"	80,9	80				5,6	555,2		3,3	326,7	

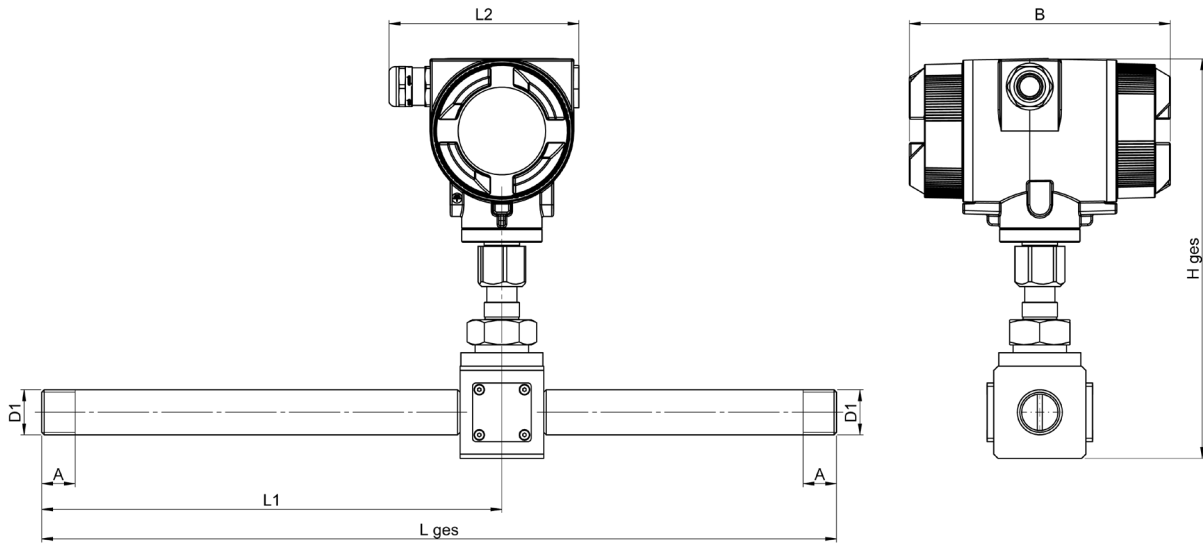

VU 570 - with thread								
Connection thread	AD pipe - mm	ID pipe - mm	L ges - mm	L1 - mm	L2 - mm	H ges - mm	B - mm	A - mm
R 1/2"	21,3	16,1	300	210	113,4	238	156	20
R 3/4"	26,9	21,7	475	275	113,4	238	156	20
R 1"	33,7	27,3	475	275	113,4	253	156	25
R 1 1/4"	42,4	36,0	475	275	113,4	253	156	25
R 1 1/2"	48,3	41,9	475	275	113,4	260	156	25
R 2"	60,3	53,1	475	275	113,4	271	156	30

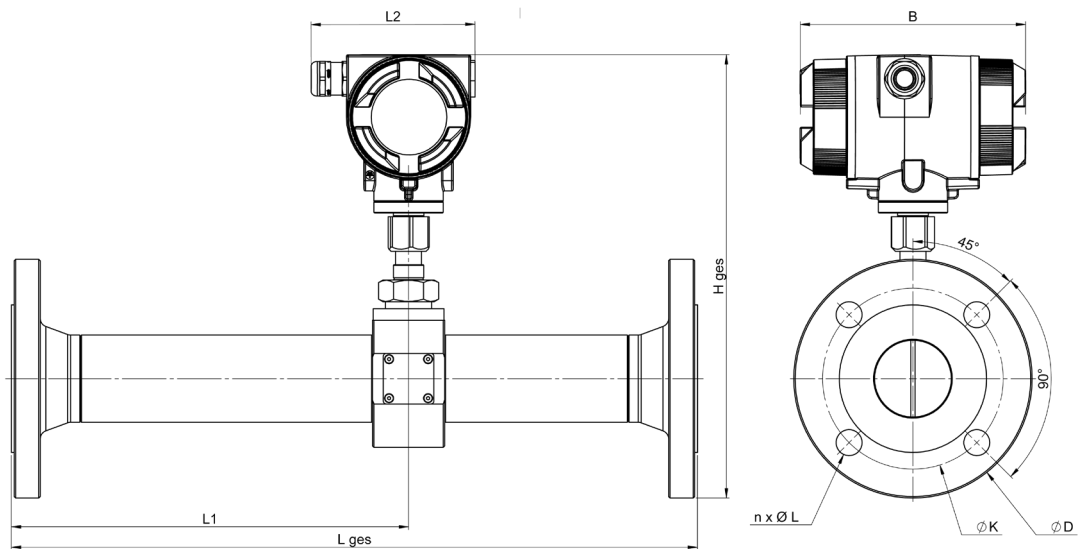

VU 570 - with flanges										
Pipe	AD pipe - mm	ID pipe - mm	L ges - mm	L1 - mm	L2 - mm	H ges - mm	B - mm	Ø D	Ø K	n x Ø L
DN 15	21,3	16,1	300	210	113,4	258,5	156	95	65	4x14
DN 20	26,9	21,7	475	275	113,4	263,5	156	105	75	4x14
DN 25	33,7	27,3	475	275	113,4	276	156	115	85	4x14
DN 32	42,4	36,0	475	275	113,4	288,5	156	140	100	4x18
DN 40	48,3	41,9	475	275	113,4	293	156	150	110	4x18
DN 50	60,3	53,1	475	275	113,4	306,5	156	165	125	4x18
DN 65	76,1	68,9	475	275	113,4	325	156	185	145	8x18
DN 80	88,9	80,9	475	275	113,4	339	156	200	160	8x18



Notizen



VX 570 - Vortex Flow sensor for steam, gases and liquids

The high-precision all-rounder with integrated pressure and temperature compensation

FIELD OF APPLICATION:

- Measurement of saturated steam or superheated steam
- Measurement of liquids
- Measurement of mixed gases
- Measurement of corrosive media

Benefits at a glance:

- Measurement of standard volume flow, operating volume flow, mass flow
- Measurement at high temperatures of up to 350°C
- Measurement up to 63 bar(g)
- Suitable for unknown/changing gas compositions and mixed gases
- Aggression resistant – all parts in contact with media made of stainless steel
- Not sensitive to vibrations due to reference vibration measurement
- No moving parts



Vortex operating principle, vortex frequency:

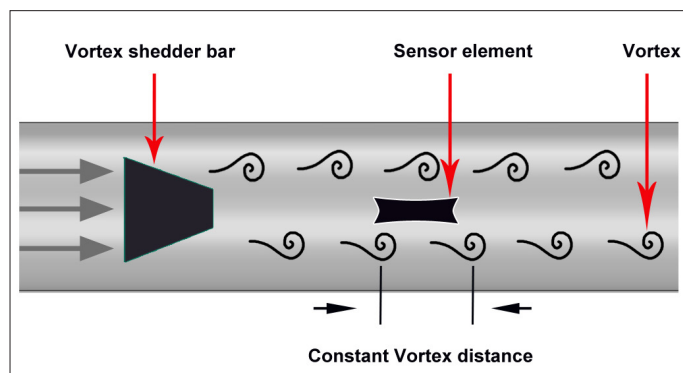



Example code for VX 570:

0698 0570_A1_B1_C1_D1_E1_F1_G1_H1_I1

Basic model	
A1	Vortex mass flow meter with integrated temperature and pressure sensor
A2	Vortex flow meter without integrated temperature and pressure sensor
Measured medium:	
B1	Steam
B2	Liquids
B3	Gas
Display option	
C1	With display
Measuring section	
D1	1/2" (DN 15)
D2	3/4" (DN 20)
D3	1" (DN 25)
D4	1 1/4" (DN 32)
D5	1 1/2" (DN 40)
D6	2" (DN 50)
D7	2 1/2" (DN 65)
D8	3" (DN 80)
D9	4" (DN 100)
D10	5" (DN 125)
D11	6" (DN 150)
D12	8" (DN 200)
D13	10" (DN 250)
D14	12" (DN 300)
Process connection	
E1	Wafer type up to 16 bar(g) / 232 psi(g)
E2	Flange DIN PN 16
E3	Flange DIN PN 25
E4	Flange DIN PN 40
E5	Flange DIN PN 63
E6	Flange ANSI Class 150 lbs
E7	Flange ANSI Class 300 lbs
E8	Flange ANSI Class 400 lbs
Signal outputs / bus connection option	
F1	3 x 4...20 mA analogue output (not electrically isolated), RS 485 (Modbus-RTU)
F3	RS 485 (Modbus-RTU)
Reference standard	
G1	20 °C, 1000 mbar
G2	0 °C, 1013.25 mbar
G3	15 °C, 981 mbar
G4	15 °C, 1013.25 mbar
G5	Operating conditions
Surface condition	
H1	Standard version
H2	Special cleaning – oil and grease free (e.g. for oxygen application)
Max. process temperature	
I1	Up to 150 °C
I2	Up to 250 °C
I3	Up to 350 °C

Measuring ranges of VX 570 (in m/s under operating conditions)						
Nominal width	Gas		Steam		Liquids	
	from	to	from	to	from	to
DN 15 - DN 20	6 m/s	60 m/s	6 m/s	70 m/s	0.3 m/s	7 m/s
DN 25 - DN 32	4 m/s	60 m/s	4 m/s	70 m/s		
DN 40 - DN 300	2 m/s	60 m/s	2 m/s	70 m/s		

TECHNICAL DATA VX 570	
Measuring range:	See table
Measured medium:	Primary single-phase gases, mixed gases, saturated steam, superheated steam and liquids
Accuracy:	Gas / Steam:
Volume flow (m³/h)	± 1 % of m.v., (Re > 20,000) ± 2 % of m.v., (10,000 < Re < 20,000)
	Liquids:
	± 0.75 % of m.v., (Re > 20,000) ± 2 % of m.v., (10,000 < Re < 20,000)
Mass flow (kg/h) or standard volume flow (Nm³/h)	Gas / Steam:
	± 1.5 % of m.v., (Re > 20,000) ± 2.5 % of m.v., (10,000 < Re < 20,000)
Measuring principle:	Vortex – vortex frequency measurement
Process temperature:	-40...+350°C
Process pressure:	Up to 63 bar(g)
Protection class	IP67
Material measuring section and parts in contact with medium:	Stainless steel SS304 (SS316 on request)
Material display unit:	Aluminium – die casting
Signal outputs:	As standard: RS 485 (Modbus-RTU), 3x 4...20 mA,
	Optional: Ethernet interface
Power supply:	18...36 VDC
Measuring span:	Gases: 1:30 Vapour: 1:35 Liquids 1:23
Viscosity	DN 15 ≤ 4 mPas DN 25 ≤ 5 mPas DN 40...DN 300 ≤ 7 mPas
Repeatability:	± 0.3 % of m.v.
Process connection:	Flange DIN EN1092-1 Flange ANSI Wafer type

DESCRIPTION	ORDER NO.
VX 570 – Vortex flow sensor for steam, gases and liquids	0698 0570 + Order code A...I_
Further accessories: ISO calibration certificate at 5 measuring points	3200 0001



Measuring ranges for gases and liquids VX 570 under operating conditions										
Inside diameter of pipe			Gases				Liquids			
			Min flow m3/h	Max flow m3/h	Min flow cfm	Max flow cfm	Min flow m3/h	Max flow m3/h	Min flow GPM	Max flow GPM
Inch	mm	DN								
1/2"	15	DN 15	3.8	44.5	2.2	26.2	0.2	4.4	0.8	19.6
3/4"	20	DN 20	6.8	79.1	4	46.6	0.3	7.9	1.5	34.8
1"	25	DN 25	7.1	123.6	4.2	72.7	0.5	12.4	2.3	54.4
1 1/4"	32	DN 32	11.6	202.5	6.8	119.2	0.9	20.2	3.8	89.2
1 1/2"	40	DN 40	9	316.4	5.3	186.2	1.4	31.6	6.0	139.3
2"	50	DN 50	14.1	494.4	8.3	291	2.1	49.4	9.3	217.7
2 1/2"	65	DN 65	23.9	835.5	14	491.7	3.6	83.5	15.8	367.8
3"	80	DN 80	36.2	1265.5	21.3	744.9	5.4	126.6	23.9	557.2
4"	100	DN 100	56.5	1977.4	33.3	1163.9	8.5	197.7	37.3	870.6
5"	125	DN 125	88.3	3089.7	52	1818.5	13.2	309.0	58.3	1360.4
6"	150	DN 150	127.1	4449.2	74.8	2618.7	19.1	444.9	84.0	1958.9
8"	200	DN 200	226	7909.6	133	4655.4	33.9	791.0	149.3	3482.5
10"	250	DN 250	353.1	12358.8	207.8	7274.1	53.0	1235.9	233.2	5441.4
12"	300	DN 300	508.5	17796.6	299.3	10474.7	76.3	1779.7	335.8	7835.6

Measuring ranges for steam VX 570 under operating conditions in kg/h																
Inside diameter of pipe			T=112 °C		T=121 °C		T=134 °C		T=144 °C		T=159 °C		T=165 °C		T=171 °C	
			P=0.5 bar(g)		P=1 bar(g)		P=2 bar(g)		P=3 bar(g)		P=5 bar(g)		P=6 bar(g)		P=7 bar(g)	
			D=0.8798 kg/m3		D=1.155 kg/m3		D=1.672 kg/m3		D=2.185 kg/m3		D=3.182 kg/m3		D=3.671 kg/m3		D=4.218 kg/m3	
Inch	mm	DN	Min	Max	Min	Max	Min	Max	Min	Max	Min	Max	Min	Max	Min	Max
1/2"	15	DN 15	3.4	39.1	4.4	51.4	6.4	74.4	8.3	97.2	12.1	141.6	14.0	163.3	16.1	187.7
3/4"	20	DN 20	6.0	69.6	7.8	91.4	11.3	132.2	14.8	172.8	21.6	251.7	24.9	290.4	28.6	333.6
1"	25	DN 25	6.2	108.7	8.2	142.7	11.8	206.6	15.4	270.0	22.5	393.3	25.9	453.7	29.8	521.3
1 1/4"	32	DN 32	10.2	178.1	13.4	233.9	19.3	338.6	25.3	442.4	36.8	644.3	42.5	743.3	48.8	854.1
1 1/2"	40	DN 40	8.0	278.4	10.4	365.4	15.1	529.0	19.8	691.3	28.8	1006.7	33.2	1161.4	38.1	1334.5
2"	50	DN 50	12.4	434.9	16.3	571.0	23.6	826.6	30.9	1080.2	44.9	1573.0	51.9	1814.8	59.6	2085.2
2 1/2"	65	DN 65	21.0	735.0	27.6	964.9	39.9	1396.9	52.2	1825.5	76.0	2658.4	87.6	3066.9	100.7	3523.9
3"	80	DN 80	31.8	1113.4	41.8	1461.7	60.5	2116.0	79.0	2765.2	115.1	4026.9	132.7	4645.8	152.5	5338.0
4"	100	DN 100	49.7	1739.7	65.3	2283.9	94.5	3306.2	123.4	4320.6	179.8	6292.1	207.4	7259.0	238.3	8340.7
5"	125	DN 125	77.7	2718.3	102.0	3568.6	147.6	5166.0	192.9	6751.0	280.9	9831.4	324.1	11342.2	372.4	13032.3
6"	150	DN 150	111.8	3914.4	146.8	5138.8	212.5	7439.0	277.8	9721.4	404.5	14157.2	466.7	16332.8	536.2	18766.5
8"	200	DN 200	198.8	6958.9	261.0	9135.6	377.9	13224.9	493.8	17282.5	719.1	25168.4	829.6	29036.2	953.2	33362.7
10"	250	DN 250	310.7	10873.2	407.8	14274.4	590.4	20663.8	771.5	27003.9	1123.6	39325.6	1296.3	45369.0	1489.4	52129.2
12"	300	DN 300	447.4	15657.5	587.3	20555.1	850.2	29755.9	1111.0	38885.6	1618.0	56628.8	1866.6	65331.4	2144.7	75066.1

Measuring ranges for steam VX 570 under operating conditions kg/h														
Inside diameter of pipe			T=176 °C		T=185 °C		T=192 °C		T=199 °C		T=210 °C		T=215 °C	
			P=8 bar(g)		P=10 bar(g)		P=12 bar(g)		P=14 bar(g)		P=18 bar(g)		P=20 bar(g)	
			D=4.723 kg/m3		D=5.752 kg/m3		D=6.671 kg/m3		D=7.706 kg/m3		D=9.593 kg/m3		D=10.57 kg/m3	
Inch	mm	DN	Min	Max	Min	Max	Min	Max	Min	Max	Min	Max	Min	Max
1/2"	15	DN 15	18.0	210.1	21.9	255.9	25.4	296.8	29.4	342.9	36.6	426.8	40.3	470.3
3/4"	20	DN 20	32.0	373.6	39.0	455.0	45.2	527.6	52.2	609.5	65.0	758.8	71.7	836.0
1"	25	DN 25	33.4	583.7	40.6	710.9	47.1	824.5	54.4	952.4	67.7	1185.6	74.6	1306.3
1 1/4"	32	DN 32	54.6	956.3	66.6	1164.7	77.2	1350.8	89.2	1560.4	111.0	1942.4	122.3	2140.3
1 1/2"	40	DN 40	42.7	1494.3	52.0	1819.8	60.3	2110.6	69.7	2438.1	86.7	3035.1	95.5	3344.2
2"	50	DN 50	66.7	2334.8	81.2	2843.5	94.2	3297.8	108.8	3809.5	135.5	4742.3	149.3	5225.3
2 1/2"	65	DN 65	112.7	3945.8	137.3	4805.5	159.2	5573.3	183.9	6438.0	229.0	8014.5	252.3	8830.7
3"	80	DN 80	170.8	5977.1	208.0	7279.4	241.2	8442.4	278.6	9752.2	346.9	12140.3	382.2	13376.7
4"	100	DN 100	266.8	9339.3	325.0	11374.0	376.9	13191.2	435.4	15237.9	542.0	18969.2	597.2	20901.1
5"	125	DN 125	416.9	14592.6	507.8	17771.9	588.9	20611.3	680.3	23809.1	846.8	29639.4	933.1	32658.0
6"	150	DN 150	600.4	21013.3	731.2	25591.5	848.0	29680.3	979.6	34285.2	1219.4	42680.7	1343.6	47027.5
8"	200	DN 200	1067.3	37357.1	1299.9	45496.0	1507.6	52765.0	1741.5	60951.4	2167.9	75876.8	2388.7	83604.5
10"	250	DN 250	1667.7	58370.4	2031.1	71087.6	2355.6	82445.3	2721.0	95236.6	3387.4	118557.6	3732.3	130632.1
12"	300	DN 300	2401.5	84053.4	2924.7	102366.1	3392.0	118721.2	3918.3	137140.7	4877.8	170722.9	5374.6	188110.2



Measuring ranges for steam VX 570 under operating conditions in lb/h																
Inside diameter of pipe			T=233.6 °F		T=249.8 °F		T=273.2 °F		T=291.2 °F		T=318.2 °F		T=329 °F		T=339.8 °F	
			P=7.3 psi(g)		P=14.5 psi(g)		P=29 psi(g)		P=43.5 psi(g)		P=72.5 psi(g)		P=87 psi(g)		P=101.5 psi(g)	
			D=0.0034 lb/ft3		D=0.0721 lb/ft3		D=0.1044 lb/ft3		D=0.1364 lb/ft3		D=0.1986 lb/ft3		D=0.2292 lb/ft3		D=0.2633 lb/ft3	
Inch	mm	DN	Min	Max	Min	Max	Min	Max	Min	Max	Min	Max	Min	Max	Min	Max
1/2"	15	DN 15	7.4	86.3	9.7	113.3	14.1	164.0	18.4	214.3	26.8	312.1	30.9	360.1	35.5	413.7
3/4"	20	DN 20	13.2	153.4	17.3	201.4	25.0	291.6	32.7	381.0	47.6	554.9	54.9	640.1	63.0	735.5
1"	25	DN 25	13.7	239.7	18.0	314.7	26.0	455.6	34.0	595.3	49.5	867.0	57.2	1000.2	65.7	1149.3
1 1/4"	32	DN 32	22.4	392.7	29.5	515.6	42.7	746.4	55.7	975.4	81.2	1420.5	93.6	1638.8	107.6	1882.9
1 1/2"	40	DN 40	17.5	613.7	23.0	805.6	33.3	1166.2	43.5	1524.1	63.4	2219.5	73.2	2560.6	84.1	2942.1
2"	50	DN 50	27.4	958.9	36.0	1258.8	52.1	1822.2	68.0	2381.3	99.1	3467.9	114.3	4000.9	131.3	4597.0
2 1/2"	65	DN 65	46.3	1620.5	60.8	2127.3	88.0	3079.6	115.0	4024.5	167.5	5860.8	193.2	6761.5	222.0	7768.9
3"	80	DN 80	70.1	2454.7	92.1	3222.5	133.3	4664.9	174.2	6096.2	253.7	8877.9	292.6	10242.2	336.2	11768.4
4"	100	DN 100	109.6	3835.4	143.9	5035.1	208.3	7289.0	272.2	9525.3	396.3	13871.7	457.2	16003.4	525.4	18388.0
5"	125	DN 125	171.2	5992.8	224.8	7867.4	325.4	11389.0	425.2	14883.3	619.3	21674.5	714.4	25005.4	820.9	28731.3
6"	150	DN 150	246.6	8629.7	323.7	11329.1	468.6	16400.2	612.3	21432.0	891.8	31211.3	1028.8	36007.7	1182.1	41373.1
8"	200	DN 200	438.3	15341.7	575.4	20140.5	833.0	29155.8	1088.6	38101.4	1585.3	55486.7	1829.0	64013.8	2101.5	73552.2
10"	250	DN 250	684.9	23971.4	899.1	31469.6	1301.6	45556.0	1701.0	59533.4	2477.1	86698.0	2857.8	100021.5	3283.6	114925.3
12"	300	DN 300	986.3	34518.8	1294.7	45316.2	1874.3	65600.6	2449.4	85728.1	3567.0	124845.2	4115.2	144031.0	4728.4	165492.4

Measuring ranges for steam VX 570 under operating conditions in lb/h																
Inside diameter of pipe			T=348.8 °F		T=365 °F		T=377.6 °F		T=390.2 °F		T=410 °F		T=419 °F			
			P=116 psi(g)		P=145 psi(g)		P=174 psi(g)		P=203 psi(g)		P=261 psi(g)		P=290 psi(g)			
			D=0.2948 lb/ft3		D=0.3591 lb/ft3		D=0.4165 lb/ft3		D=0.4811 lb/ft3		D=0.5989 lb/ft3		D=0.6599 lb/ft3			
Inch	mm	DN	Min	Max	Min	Max	Min	Max	Min	Max	Min	Max	Min	Max		
1/2"	15	DN 15	39.7	463.3	48.4	564.2	56.1	654.3	64.8	755.9	80.7	940.9	88.9	1036.8		
3/4"	20	DN 20	70.6	823.6	86.0	1003.0	99.7	1163.3	115.2	1343.7	143.4	1672.8	158.0	1843.2		
1"	25	DN 25	73.5	1286.8	89.6	1567.2	103.9	1817.6	120.0	2099.6	149.4	2613.7	164.6	2879.9		
1 1/4"	32	DN 32	120.5	2108.4	146.7	2567.7	170.2	2978.0	196.6	3440.0	244.7	4282.4	269.6	4718.5		
1 1/2"	40	DN 40	94.1	3294.3	114.6	4012.1	132.9	4653.1	153.6	5375.0	191.2	6691.2	210.6	7372.7		
2"	50	DN 50	147.1	5147.4	179.1	6268.9	207.7	7270.4	240.0	8398.4	298.7	10455.0	329.1	11519.8		
2 1/2"	65	DN 65	248.5	8699.1	302.7	10594.4	351.1	12287.0	405.5	14193.3	504.8	17668.9	556.2	19468.4		
3"	80	DN 80	376.5	13177.3	458.5	16048.3	531.8	18612.3	614.3	21500.0	764.7	26764.8	842.6	29490.6		
4"	100	DN 100	588.3	20589.6	716.4	25075.4	830.9	29081.7	959.8	33593.7	1194.9	41819.9	1316.5	46079.1		
5"	125	DN 125	919.2	32171.2	1119.4	39180.3	1298.3	45440.2	1499.7	52490.2	1867.0	65343.7	2057.1	71998.6		
6"	150	DN 150	1323.6	46326.5	1612.0	56419.7	1869.5	65433.9	2159.6	75585.9	2688.4	94094.9	2962.2	103678.0		
8"	200	DN 200	2353.1	82358.2	2865.8	100301.6	3323.6	116326.8	3839.3	134374.9	4779.4	167279.8	5266.2	184316.4		
10"	250	DN 250	3676.7	128684.7	4477.8	156721.3	5193.2	181760.7	5998.9	209960.7	7467.8	261374.7	8228.4	287994.4		
12"	300	DN 300	5294.5	185306.0	6448.0	225678.6	7478.2	261735.4	8638.4	302343.4	10753.7	376379.5	11848.9	414711.9		



Accessories VA 500/520/525

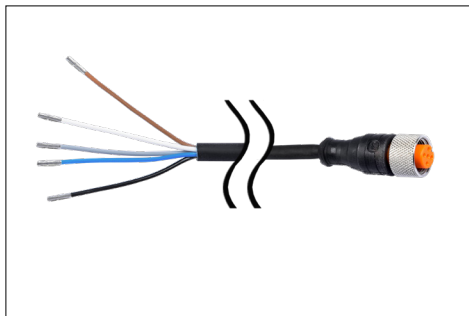

DESCRIPTION	ORDER NO.
Connection cable for VA/FA series, 5 m	0553 0104
Connection cable for VA/FA sensors, 10 m	0553 0105
Connection cable for VA/FA series, 20 m	0553 0120
Cable for alarm/pulse output, with M12 plug, 5 m	0553 0106
Cable for alarm/pulse output, with M12 plug, 10 m	0553 0107
Connection cable for VA/FA series, 5 m shielded	0553 0129
Connection cable for VA/FA series, 10 m shielded	0553 0130

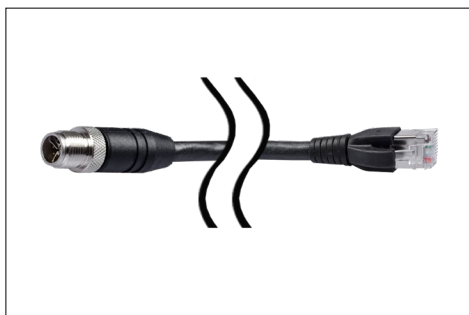

DESCRIPTION	ORDER NO.
Ethernet connection cable, length 5 m, M12 plug x-coded (8 pin) to RJ 45 plug	0553 2503
Ethernet connection cable, length 10 m, M12 plug x-coded (8 pin) to RJ 45 plug	0553 2504



DESCRIPTION	ORDER NO.
M12 T-plug for VA 500/520 for connecting multiple sensors to an M-Bus or Modbus network	0 2000 0823



DESCRIPTION	ORDER NO.
M12 plug for VA 500/520/525	0 2000 0082
M12 plug 90° angled	0219 0060

Accessories VA 500/550



DESCRIPTION	ORDER NO.
Drilling jig incl. drill (Ø 13 mm)	0530 1108



DESCRIPTION	ORDER NO.
Wall thickness measuring device CS 0495 incl. case and calibration block	0560 0495



DESCRIPTION	ORDER NO.
Welding nipple, L = 35 mm, male thread, R 1/2" stainless steel 1.4301	3300 0006
Welding nipple, L = 35 mm, male thread, R 1/2" stainless steel 1.4571	3300 0007

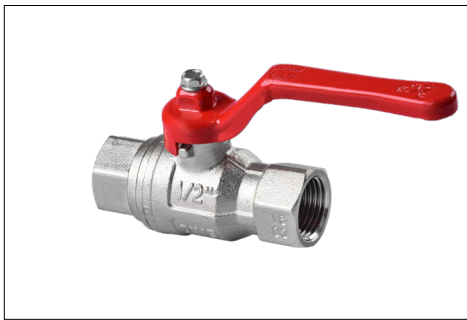

DESCRIPTION	ORDER NO.
Ball valve 1/1 G 1/2" stainless steel	3300 0002



DESCRIPTION	ORDER NO.
High-pressure safety device for the installation of insertion sensors > 10 bar, incl. ball valve	0530 2205

Order code: **0530 2205_A1_B1_C1_D1**

Sensor Type	
A1	VA 500 (up to 50 bar)
A2	VA 550 (up to 100 bar)
A3	VD 500 (up to 20 bar)

Sensor length	
B1	160 mm
B2	220 mm
B3	300 mm
B4	400 mm
B5	500 mm
B6	600 mm

Connection thread	
C1	G 1/2"
C2	NPT 1/2"

Approval	
D1	Without
D2	DVGW (up to 16 bar)



Accessories VA 500/550

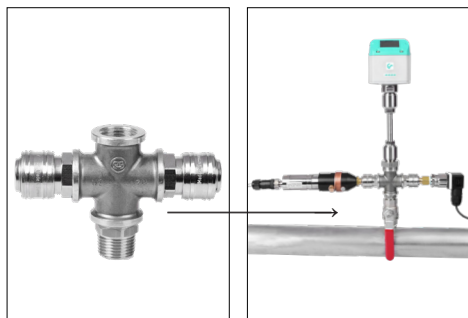

DESCRIPTION	ORDER NO.
X-connection for connection of pressure and dew point sensor at the same measuring point (incl. 2x quick-lock coupling)	0553 0133



DESCRIPTION	ORDER NO.
Thread adapter G 1/2" female thread to NPT 1/2" male thread	0553 0134

Accessories VA 550/570

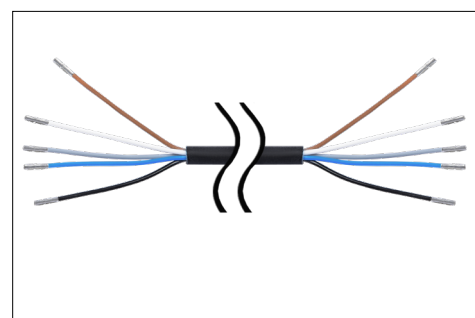

DESCRIPTION	ORDER NO.
Connection cable 5 m with open ends	0553 0108
Connection cable 10 m with open ends	0553 0109



DESCRIPTION	ORDER NO.
PNG cable screwing M20 x 1,5- for standard	0553 0552
PNG cable screwing M20 x 1,5 - for ATEX	0553 0551

Accessories VA 520/570



DESCRIPTION	ORDER NO.
Closing cap for measuring section VA 520/VA 570 (material: aluminium)	0190 0001
Closing cap for measuring section VA 520/VA 570 (material: stainless steel 1.4571)	0190 0002

Accessories for all VA 5xx



DESCRIPTION	ORDER NO.
Mains unit in wall housing for maximum 2 sensors of the series VA/FA 5xx, 100-240 V, 23 VA, 50-60 Hz / 24 VDC, 0.35 A	0554 0110
Mains unit in wall housing for max. 4 sensors of the series VA500/520 100-240 V, 23 VA, 50-60 Hz / 24 VDC, 0,35 A	0554 0111



DESCRIPTION	ORDER NO.
AC adapter plug 100-240 VAC / 24 VDC for VA/FA 5xx	0554 0109

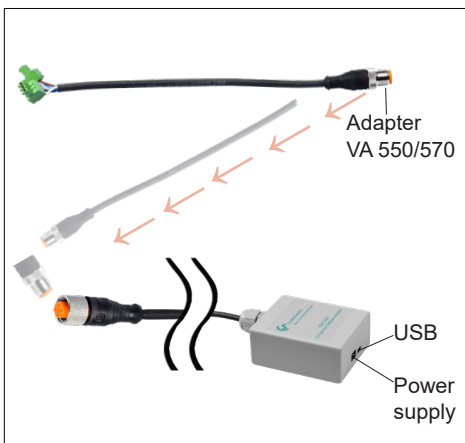

DESCRIPTION	ORDER NO.
CS Service Software incl. PC connection set, USB connection and interface adapter to the sensor	0554 2007



DESCRIPTION	ORDER NO.
External Gateway PROFIBUS for connection to integrated RS 485 interface	Z500 3008
External Gateway PROFINET for connection to integrated RS 485 interface	Z500 3009



DESCRIPTION	ORDER NO.
Case for all sensors (dimensions: 500 x 360 x 120 mm)	0554 6006

Practical measuring section accessories

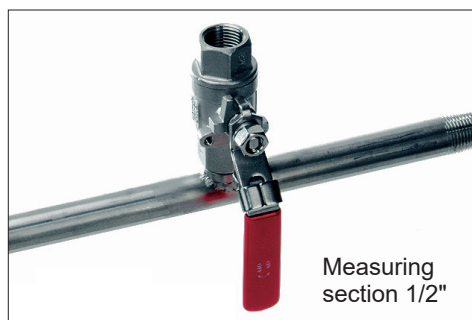

MALE THREAD	PIPE (OUTER Ø X WALL THICKNESS)	TOTAL LENGTH	ORDER NO.
R 1/2"	21.3 x 2.6 mm	500 mm	4000 0015
R 3/4"	26.9 x 2.6 mm	600 mm	4000 0020
R 1"	33.7 x 3.2 mm	750 mm	4000 0025
R 1 1/4"	42.4 x 3.2 mm	900 mm	4000 0032
R 1 1/2"	48.3 x 3.2 mm	1000 mm	4000 0040
R 2"	60.3 x 3.6 mm	1250 mm	4000 0050
R 2 1/2"	76.1 x 3.6 mm	1500 mm	4000 0065
From DN 80 with flange DIN 2633			
DN 80/88.9	88.9 x 2.0 mm	1850 mm	4000 0080
DN 100/114.3	114.3 x 2.0 mm	2104 mm	4000 0100
DN 125/139.7	139.7 x 3.0 mm	2860 mm	4000 0125
DN 150/168.3	168.3 x 3.0 mm	3110 mm	4000 0150

Measuring sections for precise measurements:

Measuring section in stainless steel 1.4301 incl. ball valve, up to DN 65 (R2 1/2") with R-male thread, from DN 80 with weld neck flange in acc. with DIN 2633.

Practical spot drilling collar accessories for compressed air lines



If there is no measuring site with 1/2" ball valve present on existing pipes, it can be set up quickly and cost-effectively by means of spot drilling collars. The spot drilling collar is imposed onto the pipe and tightened via thread rods. The enveloping rubber gasket is pressure-tight up to 11 bar. By means of the drilling jig, it is possible to drill the spot drilling collar through the 1/2" ball valve into the existing pipe.

Important: Please indicate the exact outer diameter of the existing pipe when placing the order resp. please select the suitable spot drilling collar from the adjoining list.

DESCRIPTION	DN	ORDER NO.
Spot drilling collar for pipe Ø 032 - 036 mm, length: 100 mm*		0500 0446
Spot drilling collar for pipe Ø 036 - 040 mm, length: 100 mm*		0500 0448
Spot drilling collar for pipe Ø 040 - 044 mm, length: 150 mm*		0500 0449
Spot drilling collar for pipe Ø 044 - 051 mm, length: 200 mm*		0500 0610
Spot drilling collar for pipe Ø 048 - 055 mm, length: 200 mm*	40	0500 0611
Spot drilling collar for pipe Ø 052 - 059 mm, length: 200 mm*		0500 0612
Spot drilling collar for pipe Ø 057 - 064 mm, length: 200 mm*	50	0500 0613
Spot drilling collar for pipe Ø 063 - 070 mm, length: 200 mm*		0500 0614
Spot drilling collar for pipe Ø 070 - 077 mm, length: 200 mm*	65	0500 0615
Spot drilling collar for pipe Ø 075 - 083 mm, length: 200 mm*		0500 0616
Spot drilling collar for pipe Ø 082 - 090 mm, length: 200 mm*		0500 0617
Spot drilling collar for pipe Ø 087 - 097 mm, length: 200 mm*	80	0500 0618
Spot drilling collar for pipe Ø 095 - 104 mm, length: 200 mm*		0500 0619
Spot drilling collar for pipe Ø 102 - 112 mm, length: 200 mm*		0500 0620
Spot drilling collar for pipe Ø 108 - 118 mm, length: 200 mm*	100	0500 0621
Spot drilling collar for pipe Ø 118 - 128 mm, length: 200 mm*		0500 0622
Spot drilling collar for pipe Ø 125 - 135 mm, length: 200 mm*		0500 0623
Spot drilling collar for pipe Ø 133 - 144 mm, length: 200 mm*	125	0500 0624
Spot drilling collar for pipe Ø 145 - 155 mm, length: 250 mm*		0500 0625
Spot drilling collar for pipe Ø 151 - 161 mm, length: 250 mm*	150	0500 0626
Spot drilling collar for pipe Ø 159 - 170 mm, length: 250 mm*		0500 0627
Spot drilling collar for pipe Ø 168 - 180 mm, length: 250 mm*		0500 0628
Spot drilling collar for pipe Ø 180 - 191 mm, length: 250 mm*	175	0500 0629
Spot drilling collar for pipe Ø 193 - 203 mm, length: 300 mm*		0500 0630
Spot drilling collar for pipe Ø 200 - 210 mm, length: 300 mm*		0500 0631
Spot drilling collar for pipe Ø 209 - 220 mm, length: 300 mm*	200	0500 0632

*incl. 1/2" ball valve

*not suitable for copper and plastic pipes

*not suitable for aluminum

VA 409 - Flow direction switch for compressed air systems

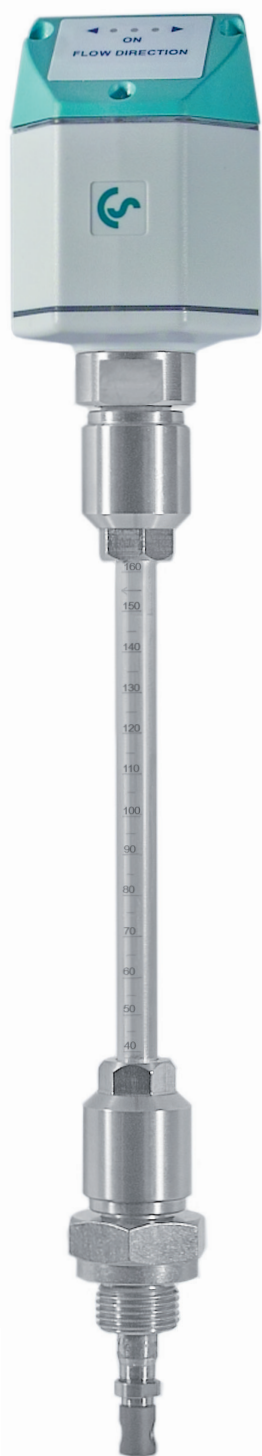

The thermal flow direction switch VA 409 with direction indication serves for determination of the flow direction of compressed air and gases especially in closed circular pipelines.

By means of VA 409 with flow direction indication the flow direction of the compressed air can be determined quickly and safely. Compared with the former mechanical paddle flow switches VA 409 is able to detect even the smallest changes in the flow direction quickly and without any mechanical movement.

The direction information in form of a potential-free contact (normally closed max. 60 VDC, 0.5 A) is transferred to the flow meters VA 5xx or to a separate building management system (BMS). Two LEDs show the flow direction.

In connection with 2 flow sensors VA 5xx incoming and out flowing compressed air in closed circular pipelines can be measured precisely.

Special features:

- detects the smallest changes < 0.1 m/s relative to 20 °C and 1,000 mbar
- no mechanical wear parts
- easy installation under pressure



TECHNICAL DATA VA 409

Response area detection of direction:	< 0.1 m/s relative to 20 °C and 1000 mbar
Measuring principle:	Calorimetric measurement
Sensor:	Pt 30/ Pt 700/ Pt 330
Measured medium:	Air, gases
Operating temperature:	0...50 °C sensor tube -20...70 °C housing
Operating pressure:	Up to 16 bar
Power supply:	24 VDC, 40 mA
Current consumption:	Max. 80 mA to 24 VDC
Protection class:	IP 54
EMC:	in acc. with DIN EN 61326
Connection:	2 x M12, 5-pin, plug A and plug B
2 potential-free contacts:	2 x U max. 60 VDC, I max 0.5 A (normally closed); on request: Normally open
Housing:	Polycarbonate
Sensor tube:	Stainless steel, 1.4301, length 160 mm, Ø 10 mm, safety ring Ø 11.5 mm, longer sensors on request
Mounting thread:	G 1/2"
Housing diameter:	65 mm
Direction indication:	2 LED'S

DESCRIPTION	ORDER NO.
Direction switch VA 409	0695 0409
Mains unit in wall housing for maximum 2 sensors of the series VA/FA 5xx, 100-240 V, 23 VA, 50-60 Hz / 24 VDC, 0,35 A	0554 0110
Connection cable for VA/FA series, 5 m	0553 0104
Connection cable for VA/FA sensors, 10 m	0553 0105

CS Service Software - for VA 5xx flow meters

... incl. PC connection set, USB connection and interface adapter to the sensor.



The flow meters VA 5xx can be connected to the PC, and the following settings can be made by means of the CS Service Software:

- Selection of gas type (air, CO₂, N₂O, N₂, O₂, NG, Ar, CH₄)
- Selection of units for flow, speed, temperature, consumption
- Selection of units: m³/h, Nm³/h, m³/min, Nm³/min, ltr/h, Nltr/h, ltr/min, Nltr/min, ltr/s, Nltr/s, cfm, SCFM, kg/h, kg/min, kg/s
- Setting of the reference temperature, reference pressure
- Zero-point adjustment, leak flow volume suppression adjustable
- Modbus and M-Bus settings
- Scaling of the 4...20 mA analogue output
- Reading of: Version number, production date, series no., time of last calibration
- Setting of alarm limits
- Offset settings (flow offset, temperature offset)
- Reset factory settings
- Load updates onto the sensor (firmware update, language update)

DESCRIPTION	ORDER NO.
CS Service Software for FA/VA sensors incl. PC connection set, USB connection and interface adapter to the sensor	0554 2007

Calibration of flow meters

In the CS calibration laboratory for flow meters it is possible to calibrate our flow measuring instruments as well as of other manufacturers High precision reference measuring devices guarantee an accuracy of up 0.5% of the measured value.

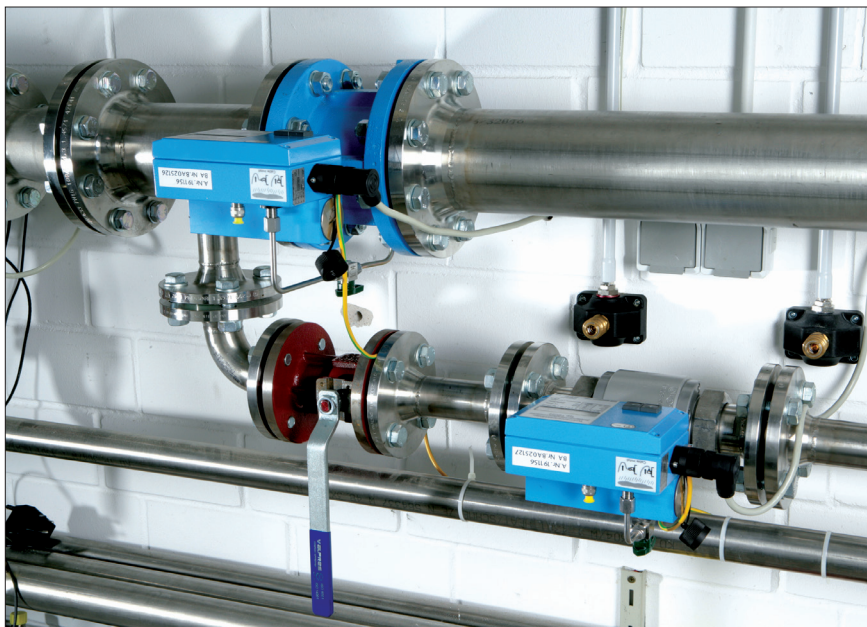
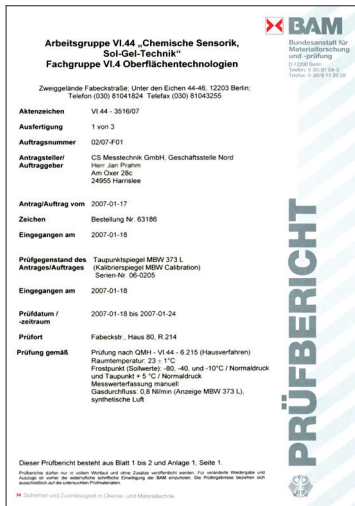

Special features:

- Due to the digital data transmission, only the flow meter must be calibrated. The display devices remain wired on site.

Calibration range:	from 0 to 4.000 m ³ /h under pressure
Accuracy of the reference:	between 0.5 and 1% of the measured value

DESCRIPTION	ORDER NO.
Recalibration and 5 point precision calibration of volume flow sensors VA 500/550 with ISO certificate	0695 3333
Recalibration and 5 point precision calibration of volume flow sensors VA 520/570 with ISO certificate	0695 3332
Volume flow, any measuring points	on request
Real gas adjustment	3200 0015

Measuring ranges VA 500 and VA 550

Measuring ranges low-speed version

Flow measuring ranges VA 500 / VA 550 - insertion meter													
Inside diameter of pipe			Low-speed version (50 m/s)										Recommended probe length
			Measuring range full scales in Nm ³ /h * / [cfm]										
Inch	mm	DN	Air**	Nitrogen (N2)	Argon (Ar)	Oxygen (O2)	Carbon dioxide (CO2)	Methane natural gas (CH4)	Helium (He)	Hydrogen (H2)	Propane (C3H8)		
1/2"	16.1	DN 15	24 [14]	22 [13]	38 [22]	23 [13]	24 [14]	14 [8]	10 [6]	7 [4]	11 [6]	160 mm - 6.299 inch	
3/4"	21.7	DN 20	48 [28]	44 [26]	75 [44]	45 [26]	47 [27]	28 [16]	20 [11]	14 [8]	22 [13]		
1"	27.3	DN 25	79 [46]	73 [43]	124 [73]	75 [44]	78 [46]	47 [27]	33 [19]	23 [13]	36 [21]		
1 1/4"	36.0	DN 32	143 [84]	132 [77]	224 [132]	136 [80]	142 [83]	85 [50]	60 [35]	42 [24]	66 [38]		
1 1/2"	41.9	DN 40	197 [116]	181 [107]	309 [182]	188 [111]	195 [115]	117 [68]	82 [48]	58 [34]	90 [53]		
2"	53.1	DN 50	323 [190]	297 [175]	506 [297]	308 [181]	320 [188]	191 [112]	135 [79]	95 [55]	148 [87]		
2 1/2"	68.9	DN 65	554 [326]	509 [300]	866 [510]	528 [311]	548 [322]	328 [193]	231 [136]	162 [95]	254 [150]	220 mm - 8.661 inch	
3"	80.9	DN 80	768 [452]	706 [415]	1201 [706]	732 [431]	760 [447]	454 [267]	321 [188]	225 [132]	353 [207]		
4"	110.0	DN 100	1426 [839]	1311 [772]	2230 [1312]	1360 [800]	1411 [830]	844 [496]	596 [350]	418 [246]	655 [386]		
5"	133.7	DN 125	2110 [1241]	1940 [1141]	3299 [1941]	2011 [1183]	2088 [1228]	1248 [734]	881 [519]	619 [364]	970 [570]	300 mm - 11.811 inch	
6"	159.3	DN 150	2999 [1765]	2758 [1623]	4689 [2759]	2859 [1682]	2967 [1746]	1774 [1044]	1253 [737]	880 [518]	1379 [811]		
8"	200.0	DN 200	4738 [2788]	4357 [2564]	7409 [4360]	4517 [2658]	4689 [2759]	2804 [1650]	1980 [1165]	1391 [819]	2178 [1282]		
10"	250.0	DN 250	7413 [4362]	6817 [4011]	11590 [6820]	7067 [4159]	7336 [4317]	4386 [2581]	3098 [1823]	2177 [1281]	3408 [2005]		
12"	300.0	DN 300	10687 [6289]	9828 [5783]	16710 [9833]	10189 [5996]	10576 [6224]	6324 [3721]	4466 [2628]	3138 [1847]	4914 [2891]		

Flow measuring ranges VA 500 / VA 550 - insertion meter														
Inside diameter of pipe			Low-speed version (50 m/s)										Recommended probe length	
			Measuring range full scales in Nm ³ /h * / [cfm]											
Inch	mm	DN	Corgon @18	Corgon @10	Corgon @20	Forming gas 90% N2 + 10% H2	Natural gas L (CH4)	Biogas 50% CH4 + 50% CO2	Biogas 60% CH4 + 40% CO2	LPG 60% C3H8 + 40% C4H10	LPG 50% C3H8 + 50% C4H10	Nitrous oxide (N2O)	Ethyne/Acetylene (C2H2)	
1/2"	16.1	DN 15	35 [21]	36 [21]	35 [20]	20 [12]	15 [9]	17 [10]	17 [10]	13 [7]	12 [7]	24 [14]	13 [8]	160 mm - 6.299 inch
3/4"	21.7	DN 20	70 [41]	71 [42]	69 [40]	40 [23]	30 [17]	34 [20]	34 [20]	25 [15]	25 [14]	47 [27]	26 [15]	
1"	27.3	DN 25	116 [68]	119 [70]	115 [67]	67 [39]	50 [29]	57 [34]	56 [33]	42 [24]	41 [24]	78 [45]	44 [26]	
1 1/4"	36.0	DN 32	209 [123]	214 [126]	208 [122]	121 [71]	91 [53]	104 [61]	101 [59]	76 [45]	74 [44]	140 [89]	80 [47]	
1 1/2"	41.9	DN 40	288 [170]	296 [174]	286 [168]	167 [98]	125 [73]	143 [84]	140 [82]	105 [62]	103 [60]	194 [114]	110 [65]	
2"	53.1	DN 50	472 [278]	484 [284]	468 [275]	273 [161]	205 [120]	235 [138]	229 [135]	172 [101]	168 [99]	317 [186]	181 [106]	
2 1/2"	68.9	DN 65	809 [476]	829 [488]	803 [472]	469 [276]	351 [207]	403 [237]	393 [231]	295 [173]	288 [169]	543 [320]	311 [183]	220 mm - 8.661 inch
3"	80.9	DN 80	1121 [660]	1149 [676]	1112 [654]	649 [382]	487 [286]	558 [328]	544 [320]	409 [240]	400 [235]	753 [443]	430 [253]	
4"	110.0	DN 100	2082 [1225]	2134 [1255]	2066 [1216]	1206 [710]	905 [532]	1037 [610]	1011 [595]	759 [447]	742 [437]	1399 [823]	800 [470]	
5"	133.7	DN 125	3080 [1813]	3156 [1857]	3056 [1798]	1785 [1050]	1338 [787]	1534 [903]	1496 [880]	1123 [661]	1098 [646]	2069 [1217]	1183 [696]	300 mm - 11.811 inch
6"	159.3	DN 150	4378 [2576]	4486 [2640]	4344 [2556]	2537 [1493]	1903 [1119]	2181 [1283]	2126 [1251]	1597 [939]	1561 [919]	2941 [1731]	1682 [990]	
8"	200.0	DN 200	6918 [4071]	7089 [4171]	6864 [4039]	4009 [2359]	3006 [1769]	3446 [2028]	3359 [1977]	2523 [1485]	2467 [1452]	4647 [2735]	2658 [1564]	
10"	250.0	DN 250	10823 [6369]	11090 [6526]	10738 [6319]	6271 [3690]	4703 [2768]	5392 [3173]	5255 [3093]	3947 [2323]	3860 [2271]	7270 [4278]	4158 [2447]	
12"	300.0	DN 300	15604 [9183]	15988 [9409]	15481 [9110]	9042 [5321]	6781 [3990]	7774 [4575]	7577 [4459]	5691 [3349]	5565 [3275]	10482 [6168]	5995 [3528]	

* Nm³/h in acc. with DIN 1343: 0 °C, 1013.25 hPa for gases

** ISO 1217: 20 °C, 1000 hPa for air

If you want to measure the consumption / flow rate of a specific gas mixture, ask us.
We can offer a real gas adjustment under process conditions on request.

Measuring ranges Standard version

Flow measuring ranges VA 500 / VA 550 - insertion meter													
Inside diameter of pipe			Standard version (92.7 m/s)										Recommended probe length
			Measuring range Nm ³ /h * / [cfm]										
Inch	mm	DN	Air**	Nitrogen (N2)	Argon (Ar)	Oxygen (O2)	Carbon dioxide (CO2)	Methane Natural gas (CH4)	Helium (He)	Hydrogen (H2)	Propane (C3H8)		
1/2"	16.1	DN 15	45 [26]	41 [24]	71 [41]	43 [25]	45 [26]	26 [15]	19 [11]	13 [7]	20 [12]	160 mm - 6.299 inch	
3/4"	21.7	DN 20	89 [52]	81 [48]	139 [81]	84 [49]	88 [51]	52 [31]	37 [21]	26 [15]	40 [24]		
1"	27.3	DN 25	147 [86]	135 [79]	230 [135]	140 [82]	146 [86]	87 [51]	61 [36]	43 [25]	67 [39]		
1 1/4"	36.0	DN 32	266 [156]	244 [144]	416 [245]	253 [149]	263 [155]	157 [92]	111 [65]	78 [46]	122 [72]		
1 1/2"	41.9	DN 40	366 [215]	337 [198]	573 [337]	349 [205]	363 [213]	217 [127]	153 [90]	107 [63]	168 [99]		
2"	53.1	DN 50	600 [353]	551 [324]	938 [552]	572 [336]	593 [349]	355 [208]	250 [147]	176 [103]	275 [162]		
2 1/2"	68.9	DN 65	1028 [604]	945 [556]	1607 [945]	980 [576]	1017 [598]	608 [358]	429 [252]	301 [177]	472 [278]	220 mm - 8.661 inch	
3"	80.9	DN 80	1424 [838]	1309 [770]	2227 [1310]	1358 [799]	1409 [829]	842 [496]	595 [350]	418 [246]	654 [385]		
4"	110.0	DN 100	2644 [1556]	2432 [1431]	4135 [2433]	2521 [1484]	2617 [1540]	1565 [921]	1105 [650]	776 [457]	1216 [715]		
5"	133.7	DN 125	3912 [2302]	3597 [2117]	6116 [3599]	3729 [2195]	3871 [2278]	2315 [1362]	1635 [962]	1149 [676]	1798 [1058]	300 mm - 11.811 inch	
6"	159.3	DN 150	5560 [3272]	5113 [3009]	8693 [5116]	5301 [3119]	5502 [3238]	3290 [1936]	2324 [1367]	1633 [961]	2556 [1504]		
8"	200.0	DN 200	8785 [5170]	8079 [4754]	13736 [8083]	8376 [4929]	8694 [5116]	5198 [3059]	3672 [2160]	2580 [1518]	4039 [2377]		
10"	250.0	DN 250	13744 [8088]	12638 [7437]	21488 [12646]	13103 [7711]	13601 [8004]	8133 [4786]	5744 [3380]	4036 [2375]	6319 [3718]		
12"	300.0	DN 300	19814 [11661]	18221 [10723]	30980 [18232]	18891 [11117]	19609 [11539]	11725 [6900]	8281 [4873]	5819 [3424]	9110 [5361]		

Flow measuring ranges VA 500 / VA 550 - insertion meter														
Inside diameter of pipe			Standard version (92.7 m/s)										Recommended probe length	
			Measuring range full scales in Nm ³ /h * / [cfm]											
Inch	mm	DN	Corgon @18	Corgon @10	Corgon @20	Forming gas 90% N2+10% H2	Natural gas L (CH4)	Biogas 50% CH4 + 50% CO2	Biogas 60% CH4 + 40% CO2	LPG 60% C3H8 + 40% C4H10	LPG 50% C3H8 + 50% C4H10	Nitrous Oxide (N2O)	Ethyne/Acetylene (C2H2)	
1/2"	16.1	DN 15	66 [39]	68 [40]	66 [38]	38 [22]	28 [17]	33 [19]	32 [19]	24 [14]	23 [13]	44 [26]	25 [15]	160 mm - 6.299 inch
3/4"	21.7	DN 20	130 [76]	133 [78]	129 [75]	75 [44]	56 [33]	64 [38]	63 [37]	47 [27]	46 [27]	87 [51]	49 [29]	
1"	27.3	DN 25	215 [126]	220 [130]	213 [125]	124 [73]	93 [55]	107 [63]	104 [61]	78 [46]	76 [45]	144 [85]	82 [48]	
1 1/4"	36.0	DN 32	388 [228]	398 [234]	385 [227]	225 [132]	168 [99]	193 [114]	188 [111]	141 [83]	138 [81]	261 [153]	149 [87]	
1 1/2"	41.9	DN 40	535 [315]	548 [322]	531 [312]	310 [182]	232 [136]	266 [157]	260 [153]	195 [114]	191 [112]	359 [211]	205 [121]	
2"	53.1	DN 50	876 [515]	897 [528]	869 [511]	507 [298]	380 [224]	436 [256]	425 [250]	319 [188]	312 [183]	588 [346]	336 [198]	
2 1/2"	68.9	DN 65	1500 [883]	1537 [905]	1489 [876]	869 [511]	652 [383]	747 [440]	728 [428]	547 [322]	535 [315]	1008 [593]	576 [339]	220 mm - 8.661 inch
3"	80.9	DN 80	2079 [1223]	2130 [1254]	2063 [1214]	1205 [709]	903 [531]	1036 [609]	1009 [594]	758 [446]	741 [436]	1397 [822]	799 [470]	
4"	110.0	DN 100	3861 [2272]	3956 [2328]	3831 [2254]	2237 [1316]	1678 [987]	1923 [1132]	1875 [1103]	1408 [828]	1377 [810]	2594 [1526]	1483 [873]	
5"	133.7	DN 125	5711 [3361]	5852 [3444]	5666 [3335]	3309 [1947]	2482 [1460]	2845 [1674]	2773 [1632]	2083 [1226]	2037 [1198]	3837 [2258]	2194 [1291]	300 mm - 11.811 inch
6"	159.3	DN 150	8118 [4777]	8318 [4895]	8054 [4740]	4704 [2768]	3528 [2076]	4044 [2380]	3942 [2320]	2961 [1742]	2895 [1704]	5453 [3209]	3119 [1835]	
8"	200.0	DN 200	12827 [7548]	13143 [7734]	12726 [7489]	7432 [4374]	5574 [3280]	6390 [3760]	6229 [3665]	4678 [2753]	4575 [2692]	8616 [5071]	4928 [2900]	
10"	250.0	DN 250	20066 [11809]	20560 [12100]	19908 [11716]	11627 [6842]	8720 [5132]	9997 [5883]	9744 [5734]	7319 [4307]	7157 [4212]	13480 [7932]	7709 [4537]	
12"	300.0	DN 300	28930 [17025]	29643 [17444]	28702 [16891]	16763 [9865]	12572 [7399]	14413 [8482]	14048 [8267]	10552 [6209]	10318 [6072]	19434 [11437]	11115 [6541]	

* Nm³/h in acc. with DIN 1343: 0 °C, 1013.25 hPa for gases

** ISO 1217: 20 °C, 1000 hPa for air

If you want to measure the consumption / flow rate of a specific gas mixture, ask us.
We can offer a real gas adjustment under process conditions on request.

Measuring ranges max version

Flow measuring ranges VA 500 / VA 550 - insertion meter													
Inside diameter of pipe			Max version (185.0 m/s)										Recommended probe length
			Measuring range Nm ³ /h * / [cfm]										
Inch	mm	DN	Air**	Nitrogen (N2)	Argon (Ar)	Oxygen (O2)	Carbon dioxide (CO2)	Methane Natural gas (CH4)	Helium (He)	Hydrogen (H2)	Propane (C3H8)		
1/2"	16.1	DN 15	90 [53]	83 [49]	142 [83]	86 [51]	90 [52]	53 [31]	38 [22]	26 [15]	41 [24]	160 mm - 6.299 inch	
3/4"	21.7	DN 20	177 [104]	163 [96]	278 [163]	169 [99]	175 [103]	105 [61]	74 [43]	52 [30]	81 [48]		
1"	27.3	DN 25	294 [173]	271 [159]	460 [271]	280 [165]	291 [171]	174 [102]	123 [72]	86 [50]	135 [79]		
1 1/4"	36.0	DN 32	531 [312]	488 [287]	830 [489]	506 [298]	525 [309]	314 [185]	222 [130]	156 [91]	244 [143]		
1 1/2"	41.9	DN 40	732 [430]	673 [396]	1144 [673]	697 [410]	724 [426]	433 [254]	305 [180]	215 [126]	336 [198]		
2"	53.1	DN 50	1197 [704]	1101 [648]	1872 [1101]	1141 [671]	1185 [697]	708 [417]	500 [294]	351 [206]	550 [324]		
2 1/2"	68.9	DN 65	2051 [1207]	1886 [1110]	3207 [1887]	1955 [1151]	2030 [1194]	1214 [714]	857 [504]	602 [354]	943 [555]	220 mm - 8.661 inch	
3"	80.9	DN 80	2842 [1672]	2614 [1538]	4444 [2615]	2710 [1594]	2813 [1655]	1682 [989]	1188 [699]	834 [491]	1307 [769]		
4"	110.0	DN 100	5278 [3106]	4854 [2856]	8252 [4856]	5032 [2961]	5223 [3074]	3123 [1838]	2206 [1298]	1550 [912]	2427 [1428]		
5"	133.7	DN 125	7807 [4594]	7179 [4225]	12206 [7183]	7443 [4380]	7726 [4546]	4620 [2718]	3263 [1920]	2293 [1349]	3589 [2112]		
6"	159.3	DN 150	11096 [6530]	10204 [6005]	17349 [10210]	10579 [6226]	10981 [6462]	6566 [3864]	4637 [2729]	3259 [1917]	5102 [3002]	300 mm - 11.811 inch	
8"	200.0	DN 200	17533 [10318]	16123 [9488]	27413 [16132]	16716 [9837]	17351 [10211]	10375 [6105]	7328 [4312]	5149 [3030]	8061 [4744]		
10"	250.0	DN 250	27428 [16141]	25223 [14843]	42884 [25237]	26150 [15389]	27143 [15974]	16231 [9552]	11463 [6746]	8055 [4740]	12611 [7421]		
12"	300.0	DN 300	39544 [23271]	36364 [21400]	61827 [36385]	37701 [22187]	39133 [23030]	23400 [13771]	16527 [9726]	11614 [6834]	18182 [10700]		

Flow measuring ranges VA 500 / VA 550 - insertion meter														
Inside diameter of pipe			Max version (185.0 m/s)											Recommended probe length
			Measuring range Nm ³ /h * / [cfm]											
Inch	mm	DN	Corgon @18	Corgon @10	Corgon @20	Forming gas 90% N2 + 10% H2	Natural gas L (CH4)	Biogas 50% CH4 + 50% CO2	Biogas 60% CH4 + 40% CO2	LPG 60% C3H8 + 40% C4H10	LPG 50% C3H8 + 50% C4H10	Nitrous Oxide (N2O)	Ethyne/Acetylene (C2H2)	
1/2"	16.1	DN 15	132 [78]	136 [80]	131 [77]	76 [45]	57 [33]	66 [38]	64 [37]	48 [28]	47 [27]	89 [52]	51 [30]	160 mm - 6.299 inch
3/4"	21.7	DN 20	259 [152]	266 [156]	257 [151]	150 [88]	112 [66]	129 [76]	126 [74]	94 [55]	92 [54]	174 [102]	99 [58]	
1"	27.3	DN 25	430 [253]	440 [259]	426 [251]	249 [146]	187 [110]	214 [126]	208 [122]	156 [92]	153 [90]	289 [170]	165 [97]	
1 1/4"	36.0	DN 32	775 [456]	795 [467]	769 [453]	449 [264]	337 [198]	386 [227]	376 [221]	283 [166]	276 [162]	521 [306]	298 [175]	
1 1/2"	41.9	DN 40	1068 [629]	1095 [644]	1060 [624]	619 [364]	464 [273]	532 [313]	519 [305]	389 [229]	381 [224]	718 [422]	410 [241]	
2"	53.1	DN 50	1748 [1029]	1791 [1054]	1734 [1020]	1013 [596]	759 [447]	871 [512]	849 [499]	637 [375]	623 [367]	1174 [691]	671 [395]	
2 1/2"	68.9	DN 65	2995 [1762]	3069 [1806]	2971 [1748]	1735 [1021]	1301 [766]	1492 [878]	1454 [856]	1092 [642]	1068 [628]	2012 [1184]	1150 [677]	220 mm - 8.661 inch
3"	80.9	DN 80	4150 [2442]	4252 [2502]	4117 [2423]	2404 [1415]	1803 [1061]	2067 [1216]	2015 [1186]	1513 [890]	1480 [871]	2788 [1640]	1594 [938]	
4"	110.0	DN 100	7706 [4535]	7896 [4647]	7646 [4499]	4465 [2628]	3349 [1971]	3839 [2259]	3742 [2202]	2811 [1654]	2748 [1617]	5177 [3046]	2961 [1742]	
5"	133.7	DN 125	11399 [6708]	11679 [6873]	11309 [6655]	6605 [3887]	4954 [2915]	5679 [3342]	5535 [3257]	4157 [2446]	4065 [2392]	7657 [4506]	4379 [2577]	
6"	159.3	DN 150	16201 [9534]	16600 [9769]	16074 [9459]	9388 [5524]	7041 [4143]	8071 [4750]	7867 [4630]	5909 [3477]	5778 [3400]	10883 [6405]	6224 [3663]	300 mm - 11.811 inch
8"	200.0	DN 200	25599 [15065]	26229 [15436]	25397 [14946]	14833 [8729]	11125 [6547]	12753 [7505]	12431 [7315]	9337 [5494]	9130 [5373]	17196 [10120]	9835 [5788]	
10"	250.0	DN 250	40046 [23567]	41033 [24148]	39731 [23382]	23205 [13656]	17404 [10242]	19951 [11741]	19447 [11444]	14606 [8596]	14283 [8406]	26901 [15831]	15386 [9054]	
12"	300.0	DN 300	57736 [33977]	59158 [34814]	57281 [33710]	33455 [19688]	25091 [14766]	28764 [16927]	28037 [16499]	21058 [12393]	20593 [12119]	38784 [22824]	22182 [13054]	

* Nm³/h in acc. with DIN 1343: 0 °C, 1013.25 hPa for gases

** ISO 1217: 20 °C, 1000 hPa for air

If you want to measure the consumption / flow rate of a specific gas mixture, ask us.
We can offer a real gas adjustment under process conditions on request.

Measuring ranges high-speed version

Flow measuring ranges VA 500 / VA 550 - insertion meter														
Inside diameter of pipe			High-speed version (224.0 m/s)											Recommended probe length
			Measuring range Nm ³ /h * / [cfm]											
Inch	mm	DN	Air**	Nitrogen (N2)	Argon (Ar)	Oxygen (O2)	Carbon dioxide (CO2)	Methane Natural gas (CH4)	Helium (He)	Hydrogen (H2)	Propane (C3H8)			
1/2"	16.1	DN 15	110 [64]	101 [59]	172 [101]	105 [61]	109 [64]	65 [38]	46 [27]	32 [19]	50 [29]		160 mm - 6.299 inch	
3/4"	21.7	DN 20	215 [126]	198 [116]	336 [198]	205 [120]	213 [125]	127 [74]	89 [52]	63 [37]	99 [58]			
1"	27.3	DN 25	356 [210]	328 [193]	557 [328]	340 [200]	353 [207]	211 [124]	149 [87]	104 [61]	164 [96]			
1 1/4"	36.0	DN 32	643 [378]	591 [348]	1006 [592]	613 [361]	636 [374]	380 [224]	268 [158]	188 [111]	295 [174]			
1 1/2"	41.9	DN 40	886 [521]	815 [479]	1385 [815]	845 [497]	877 [516]	524 [308]	370 [218]	260 [153]	407 [239]			
2"	53.1	DN 50	1450 [853]	1333 [784]	2267 [1334]	1382 [813]	1434 [844]	858 [504]	606 [356]	425 [250]	666 [392]			
2 1/2"	68.9	DN 65	2484 [1461]	2284 [1344]	3883 [2285]	2368 [1393]	2458 [1446]	1469 [865]	1038 [611]	729 [429]	1142 [672]			
3"	80.9	DN 80	3441 [2025]	3165 [1862]	5381 [3166]	3281 [1931]	3406 [2004]	2036 [1198]	1438 [846]	1010 [594]	1582 [931]			
4"	110.0	DN 100	6391 [3761]	5877 [3458]	9992 [5880]	6093 [3586]	6324 [3722]	3782 [2225]	2671 [1572]	1877 [1104]	2938 [1729]			
5"	133.7	DN 125	9453 [5563]	8693 [5116]	14780 [8698]	9012 [5304]	9355 [5505]	5594 [3292]	3951 [2325]	2776 [1633]	4346 [2558]			
6"	159.3	DN 150	13436 [7907]	12355 [7271]	21007 [12362]	12810 [7538]	13296 [7825]	7950 [4679]	5615 [3304]	3946 [2322]	6177 [3635]			
8"	200.0	DN 200	21229 [12493]	19522 [11489]	33192 [19533]	20240 [11911]	21009 [12363]	12562 [7393]	8873 [5221]	6235 [3669]	9761 [5744]			
10"	250.0	DN 250	33211 [19544]	30540 [17973]	51925 [30557]	31663 [18633]	32865 [19341]	19652 [11565]	13880 [8168]	9753 [5740]	15270 [8986]			
12"	300.0	DN 300	47880 [28177]	44030 [25912]	74861 [44055]	45649 [26864]	47383 [27885]	28333 [16674]	20012 [11777]	14062 [8275]	22015 [12956]			

Flow measuring ranges VA 500 / VA 550 - insertion meter														
Inside diameter of pipe			High-speed version (224.0 m/s)											Recommended probe length
			Measuring range Nm ³ /h * / [cfm]											
Inch	mm	DN	Corgon @18	Corgon @10	Corgon @20	Forming gas 90%N2 + 10%H2	Natural gas L (CH4)	Biogas 50%CH4 + 50%CO2	Biogas 60%CH4 + 40%CO2	LPG 60%C3H8 + 40%C4H10	LPG 50% C3H8 + 50% C4H10	Nitrous Oxide (N2O)	Ethyne/ Acetylene (C2H2)	
1/2"	16.1	DN 15	160 [94]	164 [96]	159 [93]	93 [54]	69 [41]	80 [47]	78 [45]	58 [34]	57 [33]	108 [63]	61 [36]	160 mm - 6.299 inch
3/4"	21.7	DN 20	314 [185]	322 [189]	311 [183]	182 [107]	136 [80]	156 [92]	152 [89]	114 [67]	112 [65]	211 [124]	120 [71]	
1"	27.3	DN 25	521 [306]	533 [314]	516 [304]	301 [177]	226 [133]	259 [152]	253 [148]	190 [111]	185 [109]	349 [205]	200 [117]	
1 1/4"	36.0	DN 32	939 [552]	962 [566]	932 [548]	544 [320]	408 [240]	468 [275]	456 [268]	342 [201]	335 [197]	631 [371]	360 [212]	
1 1/2"	41.9	DN 40	1294 [761]	1326 [780]	1284 [755]	749 [441]	562 [331]	644 [379]	628 [369]	472 [277]	461 [271]	869 [511]	497 [292]	
2"	53.1	DN 50	2117 [1245]	2169 [1276]	2100 [1236]	1226 [721]	920 [541]	1054 [620]	1028 [605]	772 [454]	755 [444]	1422 [836]	813 [478]	
2 1/2"	68.9	DN 65	3626 [2134]	3716 [2186]	3598 [2117]	2101 [1236]	1576 [927]	1806 [1063]	1761 [1036]	1322 [778]	1293 [761]	2436 [1433]	1393 [820]	
3"	80.9	DN 80	5025 [2957]	5149 [3030]	4985 [2934]	2911 [1713]	2183 [1285]	2503 [1473]	2440 [1436]	1832 [1078]	1792 [1054]	3375 [1986]	1930 [1136]	
4"	110.0	DN 100	9331 [5491]	9561 [5626]	9258 [5448]	5407 [3182]	4055 [2386]	4649 [2735]	4531 [2666]	3403 [2003]	3328 [1958]	6268 [3689]	3585 [2109]	
5"	133.7	DN 125	13802 [8122]	14142 [8322]	13693 [8058]	7997 [4706]	5998 [3530]	6876 [4046]	6702 [3944]	5034 [2962]	4923 [2897]	9271 [5456]	5302 [3120]	
6"	159.3	DN 150	19617 [11544]	20100 [11829]	19462 [11453]	11367 [6689]	8525 [5017]	9773 [5751]	9526 [5606]	7155 [4210]	6997 [4117]	13178 [7755]	7537 [4435]	
8"	200.0	DN 200	30996 [18241]	31759 [18690]	30752 [18097]	17960 [10569]	13470 [7927]	15442 [9087]	15051 [8858]	11305 [6653]	11055 [6506]	20821 [12253]	11908 [7008]	
10"	250.0	DN 250	48489 [28535]	49683 [29238]	48107 [28311]	28097 [16535]	21072 [12401]	24157 [14216]	23546 [13857]	17686 [10408]	17295 [10178]	32573 [19169]	18629 [10963]	
12"	300.0	DN 300	69907 [41140]	71629 [42153]	69357 [40816]	40508 [23839]	30381 [17879]	34828 [20496]	33947 [19978]	25498 [15005]	24934 [14674]	46961 [27636]	26858 [15806]	

* Nm³/h in acc. with DIN 1343: 0 °C, 1013.25 hPa for gases

** ISO 1217: 20 °C, 1000 hPa for air

If you want to measure the consumption / flow rate of a specific gas mixture, ask us.
We can offer a real gas adjustment under process conditions on request.

Measuring ranges VA 570/ VA 520/ VA 525/ VA 521

Measuring ranges low-speed version

Flow measuring ranges VA 570/ VA 520/ VA 525/ VA 521											
Inside diameter of pipe			Low-speed version (50 m/s)								
			Measuring range full scales in Nm ³ /h * / [cfm]								
Inch	mm	DN	Air**	Nitrogen (N2)	Argon (Ar)	Oxygen (O2)	Carbon dioxide (CO2)	Methane Natural gas (CH4)	Helium (He)	Hydrogen (H2)	Propane (C3H8)
1/4"	8.9	DN 8	25 NI/min [0.9]	25 NI/min [0.9]	45 NI/min [1.5]	25 NI/min [0.9]	25 NI/min [0.9]	15 NI/min [0.6]	735 NI/h [0.3]	515 NI/h [0.3]	810 NI/h [0.3]
3/8" ***	12.5	DN 10	225 NI/min [8]	205 NI/min [7.2]	20 [11.7]	215 NI/min [7.5]	225 NI/min [7.9]	130 NI/min [4.5]	95 NI/min [3.3]	65 NI/min [2.3]	100 NI/min [3.5]
1/2"	16.1	DN 15	20 [14.4]	20 [13.2]	35 [20]	20 [13.5]	20 [14.1]	240 NI/min [8.4]	170 NI/min [6]	120 NI/min [4.2]	185 NI/min [6.6]
3/4"	21.7	DN 20	45 [25]	40 [25]	75 [40]	45 [25]	45 [25]	25 [15]	20 [11.7]	235 NI/min [8.1]	20 [12.9]
1"	27.3	DN 25	75 [45]	70 [40]	120 [70]	75 [40]	75 [45]	45 [25]	30 [15]	20 [13.5]	35 [20]
1 1/4"	36.0	DN 32	140 [80]	130 [75]	220 [130]	135 [80]	140 [80]	85 [50]	60 [35]	40 [20]	65 [35]
1 1/2"	41.9	DN 40	195 [115]	180 [105]	305 [180]	185 [110]	195 [115]	115 [65]	80 [45]	55 [30]	90 [50]
2"	53.1	DN 50	320 [190]	295 [175]	505 [295]	305 [180]	320 [185]	190 [110]	135 [75]	95 [55]	145 [85]
2 1/2"	68.9	DN 65	550 [325]	505 [300]	865 [510]	525 [310]	545 [320]	325 [190]	230 [135]	160 [95]	250 [150]
3"	80.9	DN 80	765 [450]	705 [415]	1200 [705]	730 [430]	760 [445]	450 [265]	320 [185]	225 [130]	350 [205]

Flow measuring ranges VA 570/ VA 520/ VA 525/ VA 521													
Inside diameter of pipe			Low-speed version (50 m/s)										
			Measuring range Nm ³ /h * / [cfm]										
Inch	mm	DN	Corgon @18	Corgon @10	Corgon @20	Forming gas 90% N2 + 10% H2	Natural gas L (CH4)	Biogas 50% CH4 + 50% CO2	Biogas 60% CH4 + 40% CO2	LPG 60% C3H8 + 40% C4H10	LPG 50% C3H8 + 50% C4H10	Nitrous oxide (N2O)	Ethyne/Acetylene (C2H2)
1/4"	8.9	DN 8	40 NI/min [1.5]	40 NI/min [1.5]	40 NI/min [1.5]	20 NI/min [0.6]	15 NI/min [0.6]	20 NI/min [0.6]	20 NI/min [0.6]	15 NI/min [0.3]	15 NI/min [0.3]	25 NI/min [0.9]	15 NI/min [0.3]
3/8" ***	12.5	DN 10	15 [8,8]	20 [11,7]	15 [8,8]	190 NI/min [6,7]	140 NI/min [4,9]	10 [5,8]	160 NI/min [5,6]	120 NI/min [4,2]	115 NI/min [4]	220 NI/min [7,7]	125 NI/min [4,4]
1/2"	16.1	DN 15	35 [20]	35 [20]	35 [20]	20 [12]	15 [9]	15 [10,5]	15 [10,2]	215 NI/min [7,5]	210 NI/min [7,5]	20 [14,1]	225 NI/min [8,1]
3/4"	21.7	DN 20	70 [40]	70 [40]	65 [40]	40 [20]	30 [15]	30 [20]	30 [20]	25 [15]	25 [14,7]	45 [25]	25 [15]
1"	27.3	DN 25	115 [65]	115 [70]	115 [65]	65 [35]	50 [25]	55 [30]	55 [30]	40 [20]	40 [20]	75 [45]	40 [25]
1 1/4"	36.0	DN 32	205 [120]	210 [125]	205 [120]	120 [70]	90 [50]	100 [60]	100 [55]	75 [45]	70 [40]	140 [80]	80 [45]
1 1/2"	41.9	DN 40	285 [170]	295 [170]	285 [165]	165 [95]	125 [70]	140 [80]	140 [80]	105 [60]	100 [60]	190 [110]	110 [65]
2"	53.1	DN 50	470 [275]	480 [280]	465 [275]	270 [160]	205 [120]	235 [135]	225 [135]	170 [100]	165 [95]	315 [185]	180 [105]
2 1/2"	68.9	DN 65	805 [475]	825 [485]	800 [470]	465 [275]	350 [205]	400 [235]	390 [230]	295 [170]	285 [165]	540 [320]	310 [180]
3"	80.9	DN 80	1120 [660]	1145 [675]	1110 [650]	645 [380]	485 [285]	555 [325]	540 [320]	405 [240]	400 [235]	750 [440]	430 [250]

* Nm³/h in acc. with DIN 1343: 0 °C, 1013.25 hPa for gases

** ISO 1217: 20 °C, 1000 hPa for air

*** 3/8" only available with VA 520

If you want to measure the consumption / flow rate of a specific gas mixture, ask us. We can offer a real gas adjustment under process conditions on request.

Measuring ranges Standard version

Flow measuring ranges VA 570/ VA 520/ VA 525/ VA 521											
Inside diameter of pipe			Standard version (92.7 m/s)								
			Measuring range Nm ³ /h * / [cfm]								
Inch	mm	DN	Air**	Nitrogen (N2)	Argon (Ar)	Oxygen (O2)	Carbon dioxide (CO2)	Methane Natural gas (CH4)	Helium (He)	Hydrogen (H2)	Propane (C3H8)
1/4"	8.9	DN 8	50 NI/min [1.8]	50 NI/min [1.5]	85 NI/min [3]	50 NI/min [1.8]	50 NI/min [1.8]	30 NI/min [0.9]	20 NI/min [0.6]	15 NI/min [0.3]	25 NI/min [0.6]
3/8" ***	12.5	DN 10	25 [14,7]	20 [11,7]	35 [20,5]	20 [11,7]	25 [14,7]	245 NI/min [8,6]	175 NI/min [6,1]	120 NI/min [4,2]	190 NI/min [6,7]
1/2"	16.1	DN 15	45 [25]	40 [20]	70 [40]	40 [25]	45 [25]	25 [15]	15 [11.1]	220 NI/min [7.8]	20 [12.3]
3/4"	21.7	DN 20	85 [50]	80 [45]	135 [80]	80 [45]	85 [50]	50 [30]	35 [20]	25 [15]	40 [20]
1"	27.3	DN 25	145 [85]	135 [75]	230 [135]	140 [80]	145 [85]	85 [50]	60 [35]	40 [25]	65 [35]
1 1/4"	36.0	DN 32	265 [155]	240 [140]	415 [245]	250 [145]	260 [155]	155 [90]	110 [65]	75 [45]	120 [70]
1 1/2"	41.9	DN 40	365 [215]	335 [195]	570 [335]	345 [205]	360 [210]	215 [125]	150 [90]	105 [60]	165 [95]
2"	53.1	DN 50	600 [350]	550 [320]	935 [550]	570 [335]	590 [345]	355 [205]	250 [145]	175 [100]	275 [160]
2 1/2"	68.9	DN 65	1025 [600]	945 [555]	1605 [945]	980 [575]	1015 [595]	605 [355]	425 [250]	300 [175]	470 [275]
3"	80.9	DN 80	1420 [835]	1305 [770]	2225 [1310]	1355 [795]	1405 [825]	840 [495]	595 [350]	415 [245]	650 [385]

Flow measuring ranges VA 570/ VA 520/ VA 525/ VA 521													
Inside diameter of pipe			Standard version (92.7 m/s)										
			Measuring range Nm ³ /h * / [cfm]										
Inch	mm	DN	Corgon ®18	Corgon ®10	Corgon ®20	Forming gas 90% N2 + 10% H2	Natural gas L (CH4)	Biogas 50% CH4 + 50% CO2	Biogas 60% CH4 + 40% CO2	LPG 60% C3H8 + 40% C4H10	LPG 50% C3H8 + 50% C4H10	Nitrous oxide (N2O)	Ethyne/Acetylene (C2H2)
1/4"	8.9	DN 8	75 NI/min [2.7]	80 NI/min [2.7]	75 NI/min [2.7]	45 NI/min [1.5]	30 NI/min [1.2]	35 NI/min [1.2]	35 NI/min [1.2]	25 NI/min [0.9]	25 NI/min [0.9]	50 NI/min [1.8]	30 NI/min [0.9]
3/8" ***	12.5	DN 10	35 [20,5]	35 [20,5]	35 [20,5]	20 [11,7]	15 [8,8]	15 [8,8]	15 [8,8]	220 NI/min [7,7]	215 NI/min [7,5]	20 [11,7]	235 NI/min [8,2]
1/2"	16.1	DN 15	65 [35]	65 [40]	65 [35]	35 [20]	25 [15]	30 [15]	30 [15]	20 [14.1]	20 [13.8]	40 [25]	25 [15]
3/4"	21.7	DN 20	130 [75]	130 [75]	125 [75]	75 [40]	55 [30]	60 [35]	60 [35]	45 [25]	45 [25]	85 [50]	45 [25]
1"	27.3	DN 25	215 [125]	220 [130]	210 [125]	120 [70]	90 [55]	105 [60]	100 [60]	75 [45]	75 [45]	140 [85]	80 [45]
1 1/4"	36.0	DN 32	385 [225]	395 [230]	385 [225]	225 [130]	165 [95]	190 [110]	185 [110]	140 [80]	135 [80]	260 [150]	145 [85]
1 1/2"	41.9	DN 40	535 [315]	545 [320]	530 [310]	310 [180]	230 [135]	265 [155]	260 [150]	195 [110]	190 [110]	355 [210]	205 [120]
2"	53.1	DN 50	875 [515]	895 [525]	865 [510]	505 [295]	380 [220]	435 [255]	425 [250]	315 [185]	310 [180]	585 [345]	335 [195]
2 1/2"	68.9	DN 65	1500 [880]	1535 [905]	1485 [875]	865 [510]	650 [380]	745 [440]	725 [425]	545 [320]	535 [315]	1005 [590]	575 [335]
3"	80.9	DN 80	2075 [1220]	2130 [1250]	2060 [1210]	1205 [705]	900 [530]	1035 [605]	1005 [590]	755 [445]	740 [435]	1395 [820]	795 [470]

* Nm³/h in acc. with DIN 1343: 0 °C, 1013.25 hPa for gases

** ISO 1217: 20 °C, 1000 hPa for air

*** 3/8 "only available with VA 520

If you want to measure the consumption / flow rate of a specific gas mixture, ask us.
We can offer a real gas adjustment under process conditions on request.

Measuring ranges max version

Flow measuring ranges VA 570/ VA 520/ VA 525/ VA 521												
Inside diameter of pipe			Max version (185.0 m/s)									
			Measuring range Nm ³ /h * / [cfm]									
Inch	mm	DN	Air**	Nitrogen (N ₂)	Argon (Ar)	Oxygen (O ₂)	Carbon dioxide (CO ₂)	Methane Natural gas (CH ₄)	Helium (He)	Hydrogen (H ₂)	Propane (C ₃ H ₈)	
1/4"	8.9	DN 8	105 NI/min [3.6]	100 NI/min [3.3]	170 NI/min [6]	100 NI/min [3.6]	105 NI/min [3.6]	60 NI/min [2.1]	45 NI/min [1.5]	30 NI/min [0.9]	50 NI/min [1.5]	
3/8" ***	12.5	DN 10	50 [29,4]	45 [26,4]	75 [44,1]	45 [26,4]	50 [29,4]	25 [14,7]	20 [11,7]	245 NI/min [8,6]	20 [11,7]	
1/2"	16.1	DN 15	90 [50]	80 [45]	140 [80]	85 [50]	90 [50]	50 [30]	35 [20]	25 [15]	40 [20]	
3/4"	21.7	DN 20	175 [100]	160 [95]	275 [160]	165 [95]	175 [100]	105 [60]	70 [40]	50 [30]	80 [45]	
1"	27.3	DN 25	290 [170]	270 [155]	460 [270]	280 [165]	290 [170]	170 [100]	120 [70]	85 [50]	135 [75]	
1 1/4"	36.0	DN 32	530 [310]	485 [285]	830 [485]	505 [295]	525 [305]	310 [185]	220 [130]	155 [90]	240 [140]	
1 1/2"	41.9	DN 40	730 [430]	670 [395]	1140 [670]	695 [410]	720 [425]	430 [250]	305 [180]	215 [125]	335 [195]	
2"	53.1	DN 50	1195 [700]	1100 [645]	1870 [1100]	1140 [670]	1185 [695]	705 [415]	500 [290]	350 [205]	550 [320]	
2 1/2"	68.9	DN 65	2050 [1205]	1885 [1110]	3205 [1885]	1955 [1150]	2030 [1190]	1210 [710]	855 [500]	600 [350]	940 [555]	
3"	80.9	DN 80	2840 [1670]	2610 [1535]	4440 [2615]	2710 [1590]	2810 [1655]	1680 [985]	1185 [695]	830 [490]	1305 [765]	

Flow measuring ranges VA 570/ VA 520/ VA 525/ VA 521													
Inside diameter of pipe			Max version (185.0 m/s)										
			Measuring range Nm ³ /h * / [cfm]										
Inch	mm	DN	Corgon @18	Corgon @10	Corgon @20	Forming gas 90% N ₂ + 10% H ₂	Natural gas L (CH ₄)	Biogas 50% CH ₄ + 50% CO ₂	Biogas 60% CH ₄ + 40% CO ₂	LPG 60% C ₃ H ₈ + 40% C ₄ H ₁₀	LPG 50% C ₃ H ₈ + 50% C ₄ H ₁₀	Nitrous Oxide (N ₂ O)	Ethyne/ Acetylene (C ₂ H ₂)
1/4"	8.9	DN 8	155 NI/min [5.4]	160 NI/min [5.7]	155 NI/min [5.4]	90 NI/min [3]	65 NI/min [2.4]	75 NI/min [2.7]	75 NI/min [2.7]	55 NI/min [1.8]	55 NI/min [1.8]	105 NI/min [3.6]	60 NI/min [2.1]
3/8" ***	12.5	DN 10	70 [41,1]	75 [44,1]	70 [41,1]	40 [23,5]	30 [17,6]	35 [20,5]	35 [20,5]	25 [14,7]	25 [14,7]	45 [26,4]	25 [14,7]
1/2"	16.1	DN 15	130 [75]	135 [80]	130 [75]	75 [45]	55 [30]	65 [35]	60 [35]	45 [25]	45 [25]	85 [50]	50 [30]
3/4"	21.7	DN 20	255 [150]	265 [155]	255 [150]	150 [85]	110 [65]	125 [75]	125 [70]	90 [55]	90 [50]	170 [100]	95 [55]
1"	27.3	DN 25	430 [250]	440 [255]	425 [250]	245 [145]	185 [110]	210 [125]	205 [120]	155 [90]	150 [90]	285 [170]	165 [95]
1 1/4"	36.0	DN 32	775 [455]	795 [465]	765 [450]	445 [260]	335 [195]	385 [225]	375 [220]	280 [165]	275 [160]	520 [305]	295 [175]
1 1/2"	41.9	DN 40	1065 [625]	1095 [640]	1060 [620]	615 [360]	460 [270]	530 [310]	515 [305]	385 [225]	380 [220]	715 [420]	410 [240]
2"	53.1	DN 50	1745 [1025]	1790 [1050]	1730 [1020]	1010 [595]	755 [445]	870 [510]	845 [495]	635 [375]	620 [365]	1170 [690]	670 [395]
2 1/2"	68.9	DN 65	2995 [1760]	3065 [1805]	2970 [1745]	1735 [1020]	1300 [765]	1490 [875]	1450 [855]	1090 [640]	1065 [625]	2010 [1180]	1150 [675]
3"	80.9	DN 80	4150 [2440]	4250 [2500]	4115 [2420]	2400 [1415]	1800 [1060]	2065 [1215]	2015 [1185]	1510 [890]	1480 [870]	2785 [1640]	1590 [935]

* Nm³/h in acc. with DIN 1343: 0 °C, 1013.25 hPa for gases

** ISO 1217: 20 °C, 1000 hPa for air

*** 3/8 "only available with VA 520

If you want to measure the consumption / flow rate of a specific gas mixture, ask us.
We can offer a real gas adjustment under process conditions on request.

Measuring ranges high-speed version

Flow measuring ranges VA 570/ VA 520/ VA 525/ VA 521												
Inside diameter of pipe			High-speed version (224.0 m/s)									
			Measuring range Nm ³ /h * / [cfm]									
Inch	mm	DN	Air**	Nitrogen (N ₂)	Argon (Ar)	Oxygen (O ₂)	Carbon dioxide (CO ₂)	Methane Natural gas (CH ₄)	Helium (He)	Hydrogen (H ₂)	Propane (C ₃ H ₈)	
1/4"	8.9	DN 8	130 NI/min [4.5]	120 NI/min [4.2]	205 NI/min [7.2]	125 NI/min [4.2]	130 NI/min [4.5]	75 NI/min [2.7]	55 NI/min [1.8]	35 NI/min [1.2]	60 NI/min [2.1]	
3/8" ***	12.5	DN 10	60 [35,3]	55 [32,3]	95 [55,9]	55 [32,3]	60 [35,3]	35 [20,5]	25 [14,7]	15 [8,8]	25 [14,7]	
1/2"	16.1	DN 15	110 [60]	100 [55]	170 [100]	105 [60]	105 [60]	65 [35]	45 [25]	30 [15]	50 [25]	
3/4"	21.7	DN 20	215 [125]	195 [115]	335 [195]	205 [120]	210 [125]	125 [70]	85 [50]	60 [35]	95 [55]	
1"	27.3	DN 25	355 [210]	325 [190]	555 [325]	340 [200]	350 [205]	210 [120]	145 [85]	100 [60]	160 [95]	
1 1/4"	36.0	DN 32	640 [375]	590 [345]	1005 [590]	610 [360]	635 [370]	380 [220]	265 [155]	185 [110]	295 [170]	
1 1/2"	41.9	DN 40	885 [520]	815 [475]	1385 [815]	845 [495]	875 [515]	520 [305]	370 [215]	260 [150]	405 [235]	
2"	53.1	DN 50	1450 [850]	1330 [780]	2265 [1330]	1380 [810]	1430 [840]	855 [500]	605 [355]	425 [250]	665 [390]	
2 1/2"	68.9	DN 65	2480 [1460]	2280 [1340]	3880 [2285]	2365 [1390]	2455 [1445]	1465 [865]	1035 [610]	725 [425]	1140 [670]	
3"	80.9	DN 80	3440 [2025]	3165 [1860]	5380 [3165]	3280 [1930]	3405 [2000]	2035 [1195]	1435 [845]	1010 [590]	1580 [930]	

Flow measuring ranges VA 570/ VA 520/ VA 525/ VA 521													
Inside diameter of pipe			High-speed version (224.0 m/s)										
			Measuring range Nm ³ /h * / [cfm]										
Inch	mm	DN	Corgon @18	Corgon @10	Corgon @20	Forming gas 90% N ₂ + 10% H ₂	Natural gas L (CH ₄)	Biogas 50% CH ₄ + 50% CO ₂	Biogas 60% CH ₄ + 40% CO ₂	LPG 60% C ₃ H ₈ + 40% C ₄ H ₁₀	LPG 50% C ₃ H ₈ + 50% C ₄ H ₁₀	Nitrous Oxide (N ₂ O)	Ethyne/ Acetylene (C ₂ H ₂)
1/4"	8.9	DN 8	190 NI/min [6.6]	195 NI/min [6.9]	190 NI/min [6.6]	110 NI/min [3.9]	80 NI/min [2.7]	95 NI/min [3.3]	90 NI/min [3.3]	70 NI/min [2.4]	65 NI/min [2.4]	125 NI/min [4.5]	70 NI/min [2.4]
3/8" ***	12.5	DN 10	85 [50]	90 [52,9]	85 [50]	50 [29,4]	35 [20,5]	40 [23,5]	40 [23,5]	30 [17,6]	30 [17,6]	60 [35,3]	30 [17,6]
1/2"	16.1	DN 15	160 [90]	160 [95]	155 [90]	90 [50]	65 [40]	80 [45]	75 [45]	55 [30]	55 [30]	105 [60]	60 [35]
3/4"	21.7	DN 20	310 [185]	320 [185]	310 [180]	180 [105]	135 [80]	155 [90]	150 [85]	110 [65]	110 [65]	210 [120]	120 [70]
1"	27.3	DN 25	520 [305]	530 [310]	515 [300]	300 [175]	225 [130]	255 [150]	250 [145]	190 [110]	185 [105]	345 [205]	200 [115]
1 1/4"	36.0	DN 32	935 [550]	960 [565]	930 [545]	540 [320]	405 [240]	465 [275]	455 [265]	340 [200]	335 [195]	630 [370]	360 [210]
1 1/2"	41.9	DN 40	1290 [760]	1325 [780]	1280 [755]	745 [440]	560 [330]	640 [375]	625 [365]	470 [275]	460 [270]	865 [510]	495 [290]
2"	53.1	DN 50	2115 [1245]	2165 [1275]	2100 [1235]	1225 [720]	920 [540]	1050 [620]	1025 [605]	770 [450]	755 [440]	1420 [835]	810 [475]
2 1/2"	68.9	DN 65	3625 [2130]	3715 [2185]	3595 [2115]	2100 [1235]	1575 [925]	1805 [1060]	1760 [1035]	1320 [775]	1290 [760]	2435 [1430]	1390 [820]
3"	80.9	DN 80	5025 [2955]	5145 [3030]	4985 [2930]	2910 [1710]	2180 [1285]	2500 [1470]	2440 [1435]	1830 [1075]	1790 [1050]	3375 [1985]	1930 [1135]

* Nm³/h in acc. with DIN 1343: 0 °C, 1013.25 hPa for gases

** ISO 1217: 20 °C, 1000 hPa for air

*** 3/8 "only available with VA 520

If you want to measure the consumption / flow rate of a specific gas mixture, ask us.
We can offer a real gas adjustment under process conditions on request.

Measuring compressed air consumption and saving energy

Compressed air is one of the most expensive forms of energy at all. An intelligent use of compressed air holds enormous savings potential.

Therefore a consumption measurement that can measure and record the actual compressed air consumption and even the smallest leaks quickly and reliably is very helpful.

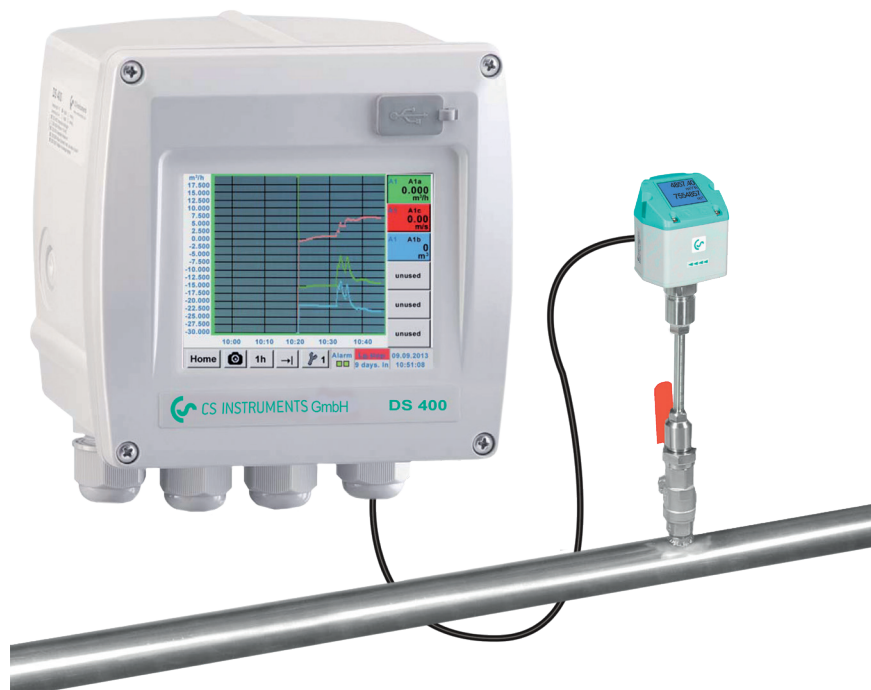

If we talk about operating costs in compressed air systems, we are actually talking about the energy costs. Because the electricity costs make up about 70-80% of the total cost of a compressed air system.

Depending on the size of the system, this means considerable operating costs. Even in smaller systems, this may quickly add up to €10,000 to 20,000 per year. This is an amount which can be considerably reduced – even in case of well operated and maintained plants.

In case of a three shift operation with 200 kW compressor performance a bad compressed air distribution can create redundant energy costs of more than 50,000 € per year.

This mainly relates to the detection of leaks and the correct design of the compressed air lines to minimize the pressure losses.

Energy resources like electricity, water or gas are usually monitored and therefore the costs are transparent.

Contrary to compressed air, a water leak is usually found quickly due to the visibility of the leak and therefore is fixed immediately. Leakages in the compressed air network „blow out“ unnoticed, even on weekends and during production stops.

The compressors continue to run during this time just to maintain a constant pressure in the network. For mature compressed air networks, the leak rate can be between 25 and 35 percent.

They are the most industrious consumers working 365 days a year.

Not considered in these considerations are the costs of producing clean and dry compressed air. Refrigeration and adsorption dryers dry the air with significant operating costs, which then „blow out“ useless through leaks.

With constantly rising energy costs, these energy savings have to be implemented in order to stay competitive within the market. Potential savings can only be exploited if the consumption of individual machines or systems is known and made transparent for all.

However, often there is no knowledge about the leak ratio. In the following we show you how leakage rate can be determined easily in your company.

Formerly the simple but inaccurate container method was applied very often. A simplified determination of the leakages is possible by means of the emptying of the tank. To carry out this measurement you just need a clock and a manometer.

Furthermore you should know the storage volume of the tank as well as of the compressed air system.

For measurement first the tank and the compressed air system are set to the upper cut-out pressure value. All compressed air consumers have to be switched off. Then the compressor is switched off and there will be no compressed air feeding into the system.

Now the time T which elapses until there is a pressure drop of 1 to 2 bar due to the leakages is measured. The pressure drop between which the measurement is taking place can be selected freely.

However, in practice the described method is very time-consuming, not adequate and inaccurate due to the following reasons:

- Storage volume, distribution pipelines cannot be determined exactly
- The accuracy of the differential pressure measurement and time measurement has to be observed
- During the pressure drop, the compressed air volume cools down and therefore changes the volume flow reference value.
- An online measurement with consumption report is not possible.

This method belongs to the so-called indirect measurements, like also the method of the load and unload measurement during which the current intake is measured by means of clamp-on ammeters and calculated back to the volume flow over the technical data of the compressor.

These indirect methods are antiquated and not suitable to detect leakages in the lower measuring range.

Determination of compressed air leakages with modern flow meters

A modern compressed air consumption measurement resp. leakage measurement should be able to measure the real compressed air flow and also the smallest leakages quickly and reliably and record them.

New: Flow measurement DS 400 for compressed air and gases

Worldwide unique with 3.5 inch, graphic display with touch screen and print function.

With the new "ready for plug-in" flow measurement DS 400 the current flow in m³/h, l/min etc. as well as the consumption in m³ or l can be measured.

The new flow station works according to the approved calorimetric measuring principle.

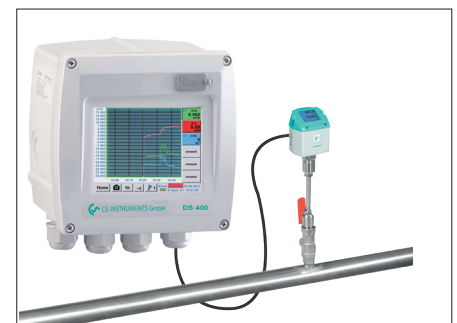

The heart is the flow sensor which has been proven and tested for years.

It is characterized by a new thermally more efficient sensor structure which shows a higher chip temperature in case of same electrical connection values. Compared to other calorimetric measuring instruments the sensor has a considerably lower mass and therefore a faster response time.

An additional pressure and temperature compensation is not necessary. The advantage is that the user can use the flow meters in different pressures and temperatures without any further compensation.

In addition to compressed air, other gases such as

- nitrogen
- oxygen
- CO₂
- argon
- natural gas
- helium

can also be measured.

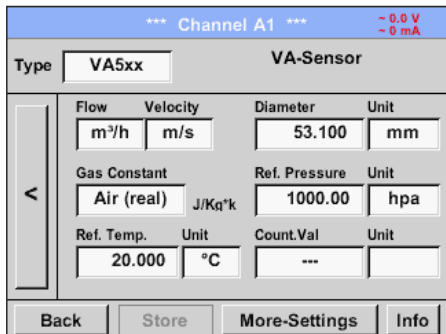

Threshold value exceedance can be reported optically and acoustically. 2 relays for pre- and main alarm are freely adjustable.

An alarm delay can be set for each relay. This grants that only really long-term threshold value exceedances are indicated.

Additionally every alarm can be reset.

The intuitive operation with the 3.5 inch touch screen graphic display with zoom function and print key is one of its kind in the world in this price class.

The graphic display with zoom function shows the actual flow, the peak values and the leakage at a glance, the values are stored in the data logger.

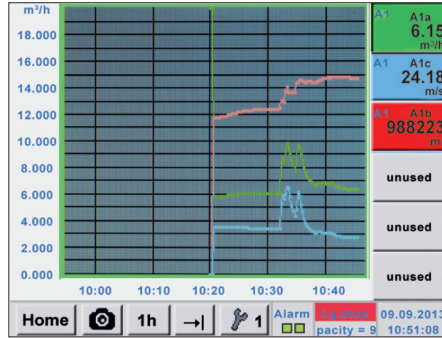

So the user can take a look at the stored measurement curves also without any computer at any time on site. This grants a quick and easy analysis of the compressed air or gas consumption.

With the print key, the current screen can be saved as an image file on the internal SD card or on a USB stick and can be printed out without additional software on a PC.

Ideal for documentation of the measured values/measurement curves on site. Colored measurement curves can be sent by e-mail as image files or integrated into a service report.

The internal data logger enables the storage of the measured data for several years.

The measured data can be evaluated via a USB stick or via Ethernet by means of the comfortable software CS Soft Basic.

Particularly comfortable is the consumption analysis at the touch of a button.

The CS Soft Basic automatically draws up daily, weekly and monthly reports.

Special features:

- 3.5" graphic display – easy to use with touchscreen
- Zoom function for accurate analysis of measured values
- Consumption analysis with daily/weekly/monthly reports
- Colored measurement curves with names
- Mathematical calculation function, e.g. addition of several consumers to a total consumption or energy costs per kWh/m³
- Print key: optional indications can be stored as image files directly on a USB stick and sent by e-mail without any software
- 2 alarm contacts for threshold value exceedance
- Freely adjustable alarm delay for both alarm contacts with reset function
- Up to 4 sensor inputs for: additional flow meters, dew point, pressure, temperature sensors, electrical effective power meters, optional third-party sensors can be connected: Pt 100/1000, 0/4...20 mA, 0-1/10 V, Modbus, pulse
- Integrated data logger 8 GB
- USB, Ethernet interface, RS 485
- Web server

Installation VA 500 under pressure



VA 500 flow meter for compressed air and gases

Even under pressure, the flow probe VA 500 is mounted by means of a standard 1/2" ball valve.

During mounting and dismounting the safety ring avoids an uncontrolled ejection of the probe which may be caused by the operating pressure.

For the mounting into different pipe diameters, VA 500 is available in the following probe lengths: 120, 160, 220, 300, 400 mm.

The flow probes are thus suitable for being mounted into existing pipes with diameters of 1/2" to DN 1000 upwards.

The exact positioning of the sensor in the middle of the pipe is granted by means of the engraved depth scale. The maximum mounting depth corresponds to the respective probe length.

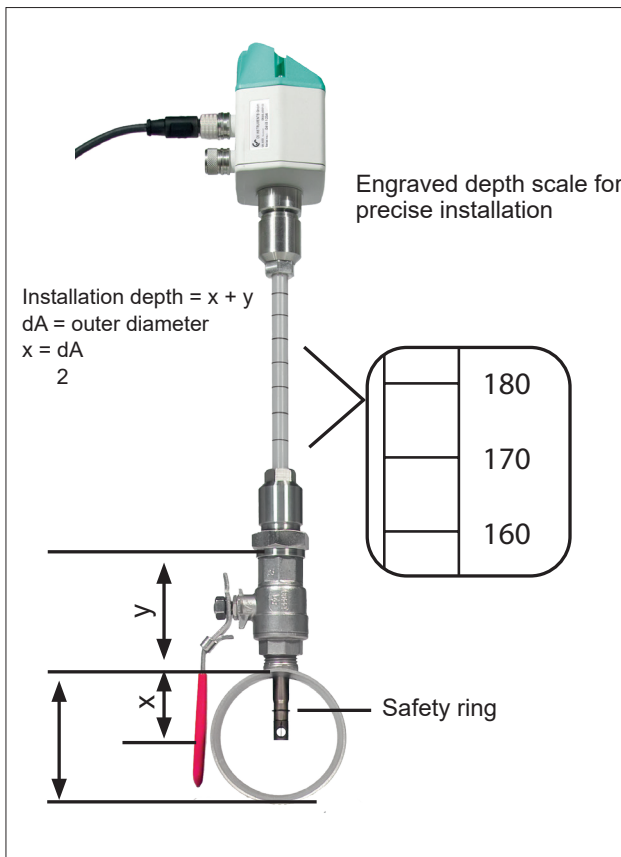

Configuring the measuring site

If there is no suitable measuring site with 1/2" ball valve, there are two simple possibilities to set up a measuring site:

- A Weld on a 1/2" screw neck and screw on a 1/2" ball valve
- B Mount spot drilling collar incl. ball valve (see accessories)

By means of the drilling jig, it is possible to drill under pressure through the 1/2" ball valve into the existing pipe.

The drilling chips are collected in a filter. Then install the probe as described above.

Due to the large measuring range of the probes, even extreme requirements placed on the consumption measurement (high volume flow in small pipe diameters) can be met.

(The measuring range depends on the pipe diameter).



Measure compressed air quality according to ISO 8573

Residual oil - particles - residual moisture



Residual oil content measurement – OIL-Check 400

For permanent and highly precise measurement of the vaporous residual oil content from 0.001 mg/m³ to 2.5 mg/m³. Due to the low detection limit of 0.001 mg/m³, the compressed air quality class 1 (ISO 8573) can be monitored.

Particle counter PC 400

The highly precise, optical particle counter PC 400 measures particles from a size of 0.1 µm and is therefore suitable for monitoring the compressed air quality class 1 (ISO 8573).

Moisture – dew point sensor FA 510

FA 510 measures the pressure dew point down to -80 °Ctd. Also in this case the continuous measurement takes care that alert is triggered immediately if the compressed air dryer breaks down.

DS 500 - the intelligent chart recorder of the next generation

The centerpiece of compressed air quality measurement is the chart recorder DS 500. It measures and documents the measured data of the sensors for residual oil content, particles and moisture. The measured values are indicated on a 7" colour screen. The curve progressions from the begin-

ning of the measurement can be viewed by an easy slide of the finger. The integrated data logger stores the measured values safely and reliably. The threshold value can be freely entered for each measured parameter. 4 alarm relays are available for automatic alarm in case of threshold value exceedance. Optionally DS 500 can be upgraded with up to 12 sensor inputs. For connection to a PLC DS 500 has an Ether-

net interface as well as a RS 485 interface. The communication is done via the Modbus protocol.

ISO 8573-1:2010 Class	Solid particles			Humidity	Oil
	Number of particles per m ³			Pressure dew point	Total share of oil (liquid aerosol and vaporous)
	0.1 - 0.5 µm	0.5 - 1 µm	1 - 5 µm		mg/ m ³
0	In accordance with specification by the device user, stricter requirements than class 1				
1	≤ 20,000	≤ 400	≤ 10	≤ -70 °C	≤ 0.01
2	≤ 400,000	≤ 6,000	≤ 100	≤ -40 °C	≤ 0.1
3	--	≤ 90,000	≤ 1,000	≤ -20 °C	≤ 1
4	--	--	≤ 10,000	≤ +3 °C	≤ 5
5	--	--	≤ 100,000	≤ +7 °C	--
6	--	--	--	≤ +10 °C	--
7	--	--	--	--	--
8	--	--	--	--	--
9	--	--	--	--	--
X	--	--	--	--	--



Stationary solution

DESCRIPTION	ORDER NO.
DS 500 – intelligent chart recorder in basic version (4 sensor inputs)	0500 5000
CS Basic - data evaluation in graphic and table form - readout of the measured data via USB or Ethernet. License for 2 working places	0554 8040
Residual oil measurement: OIL-Check 400 – residual oil measurement of the vaporous residual oil content from 0.001...2.5 mg/m ³ , 3...16 bar. Highly precise PID sensor, integrated mini catalyst for zero point calibration, without integrated display, with analogue output 0...10 volts for connection to external chart recorders	0699 0070
Sampling system OIL-Check 400: Sampling system consisting of ½" ball valve (oil- and grease-free), 1 m stainless steel tube 6x1 mm (oil- and grease-free), clamp screwing (oil- and grease-free)	Z699 0075
Alternative: Portable sampling system consisting of 2 m PTFE hose, quick coupling (oil- and grease-free)	Z699 0074
Options for systems > 16 bar: Pressure reducer (oil- and grease-free), input pressure max. 300 bar, output pressure up to 10 bar	Z699 0076
Connection cable for probes 5 m with open ends	0553 0108
PC 400 particle counter up to 0.1 µm for compressed air and gases, incl. pressure reducer/sampling hose, calibration certificate, Modbus-RTU interface	0699 0040
Connection cable for probes 5 m with open ends	0553 0108
FA 510 dew point sensor for adsorption dryers -80 °...+20 °Ctd incl. factory certificate, 4...20 mA analogue output (3-wire connection) and Modbus-RTU interface	0699 0510
Standard measuring chamber up to 16 bar	0699 3390
Connection cable for VA/FA series, 5 m	0553 0104

Mobile solution with DS 500 mobile, OIL-Check 400, PC 400, FA 510



DESCRIPTION	ORDER NO.
DS 500 mobile - intelligent chart recorder with 4 sensor inputs	0500 5012
CS Basic - data evaluation in graphic and table form - readout of the measured data via USB or Ethernet. License for 2 working places	0554 8040
Residual oil measurement: OIL-Check 400 – residual oil measurement of the vaporous residual oil content from 0.001...2.5 mg/m ³ , 3...16 bar. Highly precise PID sensor, integrated mini catalyst for zero point calibration, without integrated display, with analogue output 0...10 volts for connection to external chart recorders	0699 0070
Mobile transport trolley including roles (outer dimensions: 0,68 x 1,06 x 0,41 m) (W x H x D) with firmly mounted components of OIL-Check 400, PC 400, FA 510	0554 6017
Mobile sampling system consisting of 2 m PTFE hose, quick coupling (oil- and grease-free)	Z699 0074
Connection cable for pressure, temperature, third party sensors to portable devices, ODU/ open ends, 5 m	0553 0501
PC 400 particle counter up to 0.1 µm for compressed air and gases, incl. pressure reducer/sampling hose, calibration certificate, Modbus-RTU interface	0699 0040
Connection cable to portable devices, ODU/ M12, 5 m	0553 1503
FA 510 dew point sensor, -80...+20 °Ctd incl. measuring chamber mobile and 5 m connection cable to mobile devices	0699 1510



OIL-Check 400

The monitoring system for permanent highly precise measurement of the vaporous residual oil content in compressed air



Advantages at a glance:

- Permanent, highly precise residual oil measurement (oil vapour) with PID sensor (photo-ionic-detector)
- Ideal for mobile measurement: The PID sensor is ready for measurement within about 30 minutes
- Measuring results with long-term stability due to automatic zero point calibration. The integrated mini catalyst reliably generates a defined reference gas for zero point calibration
- In contrast to measuring systems which generate the “zero air” or reference gas by means of active carbon filters and which are therefore dependent on the ageing and saturation of the active carbon filters, the mini catalyst generates the “zero air” without ageing or wear. There is no change of active carbon filters necessary
- Easy sampling via PTFE hose or stainless steel pipe

Integrated chart recorder DS 400:

- Data logger for long-term monitoring
- Display shows trend curves (online and history curves available)
- Zoom function directly on the touch screen
- Integrated Ethernet interface (Modbus/TCP) and RS 485 interface (Modbus-RTU) for data transfer to superordinate controls
- 2 alarm relays (changeover contact 230 VAC, 3A) – threshold values freely adjustable
- Easy operation via 3.5" touchscreen

TECHNICAL DATA OIL-CHECK 400

Measured medium:	Compressed air, free from aggressive, corrosive, acid, toxic, flammable and oxidising components.
Measuring unit:	Residual oil content in mg oil/norm m ³ relative to 1.0 bar [abs], +20 °C, 0% relative humidity, in accordance with ISO 8573-1
Identifiable substances:	Hydrocarbons, functional hydrocarbons, aromatic hydrocarbons
Field of application:	After activated carbon filter, after activated carbon adsorber, after oil-free compressor, always with connected upstream filtration and dryer
Ambient temperature:	+5 °C... +45 °C, rel. humidity ≤ 75% without condensation
Pressure dew point:	max. +10 °Ctd.
Compressed air temp.:	+5 °C... +50 °C
Operational overpressure:	3...16 bar [ü] optional pressure reducer connected upstream for up to 300 bar [ü]
Setting operational pressure:	By means of integrated pressure reducer with display
Humidity of measured gas:	≤ 40% rel. humidity, pressure dew point max. +10 °C, non-condensable humidity
Compressed air connection:	G 1/8" female thread according to ISO 228-1
Measured values:	mg/norm m ³ , pressure and temperature compensated residual oil vapour content
Measuring range:	0.001 ... 2.5 mg/m ³
Detection limit (residual oil):	0.001 mg/m ³
Flow of measuring gas:	approx. 1.20 norm litres/minute, relative to 1.0 bar [abs] and + 20 °C, in a relaxed state
Reference gas generation:	By means of integrated mini catalyst
Power supply:	100...240 VAC / 1 Ph. / PE / 50...60 Hz / ± 10%
Outputs:	Ethernet interface (Modbus/TCP), RS 485 interface (Modbus-RTU), 2 alarm relays (change 230 VAC 3A), 4...20 mA (on request)
Operating hours counter:	integrated
Dimensions (mm):	410 x 440 x 163 (W x H x D)
Weight:	approx. 16.3 kg

OIL-Check 400 - Stationary solution



DESCRIPTION	ORDER NO.
OIL-Check 400 – residual oil measurement of the vaporous residual oil content from 0.001...2.5 mg/m ³ , 3...16 bar. Highly precise PID sensor, integrated mini catalyst for zero point calibration, without integrated display, with analogue output 0...10 volts for connection to external chart recorders	0699 0070
Option: DS 400 chart recorder integrated into OIL-Check 400	Z699 0071
Sampling system OIL-Check 400: Sampling system consisting of ½" ball valve (oil- and grease-free), 1 m stainless steel tube 6x1 mm (oil- and grease-free), clamp screwing (oil- and grease-free)	Z699 0075
Portable sampling system consisting of 2 m PTFE hose, quick coupling (oil- and grease-free)	Z699 0074
For systems > 16 bar: Pressure reducer (oil- and grease-free), input pressure max. 300 bar, output pressure up to 10 bar	Z699 0076
Options for the DS 400: Integrated data logger for 100 million measured values	Z500 4002
Integrated Ethernet and RS 485 interface	Z500 4004
Integrated webserver	Z500 4005
2 additional sensor inputs for analogue sensors (pressure sensors, temperature sensors etc.)	Z500 4001
CS Basic - data evaluation in graphic and table form - readout of the measured data via USB or Ethernet. License for 2 working places	0554 8040

OIL-Check 400 - Portable solution with handle



Handle and stand



Flight case

DESCRIPTION	ORDER NO.
OIL-Check 400 – residual oil measurement of the vaporous residual oil content from 0.001...2.5 mg/m ³ , 3...16 bar. Highly precise PID sensor, integrated mini catalyst for zero point calibration, without integrated display, with analogue output 0...10 volts for connection to external chart recorders	0699 0070
Option: DS 400 chart recorder integrated into OIL-Check 400	Z699 0071
Handle and stand for mobile use of the OIL-Check 400	Z699 0072
Flight case for OIL-Check 400	Z699 0073
Portable sampling system consisting of 2 m PTFE hose, quick coupling (oil- and grease-free)	Z699 0074
Options for the DS 400: Integrated data logger for 100 million measured values	Z500 4002
Integrated Ethernet and RS 485 interface	Z500 4004
Integrated webserver	Z500 4005
2 additional sensor inputs for analogue sensors (pressure sensors, temperature sensors etc.)	Z500 4001
CS Basic - data evaluation in graphic and table form - readout of the measured data via USB or Ethernet. License for 2 working places	0554 8040



DESCRIPTION	ORDER NO.
Replacement unit OIL-Check for the period of re-calibration	0699 3910
Replacement unit OIL-Check incl. DS 400 for the period of re-calibration	0699 3920
Re-calibration OIL-Check 400 incl. certificate	0699 3401
Re-calibration and maintenance OIL-Check 400 incl. certificate, rate 1 for up to 8760 operating hours	0699 3402
Re-calibration and maintenance OIL-Check 400 incl. certificate, rate 2 from 8760 operating hours	0699 3403



Particle counter PC 400 and DS 400

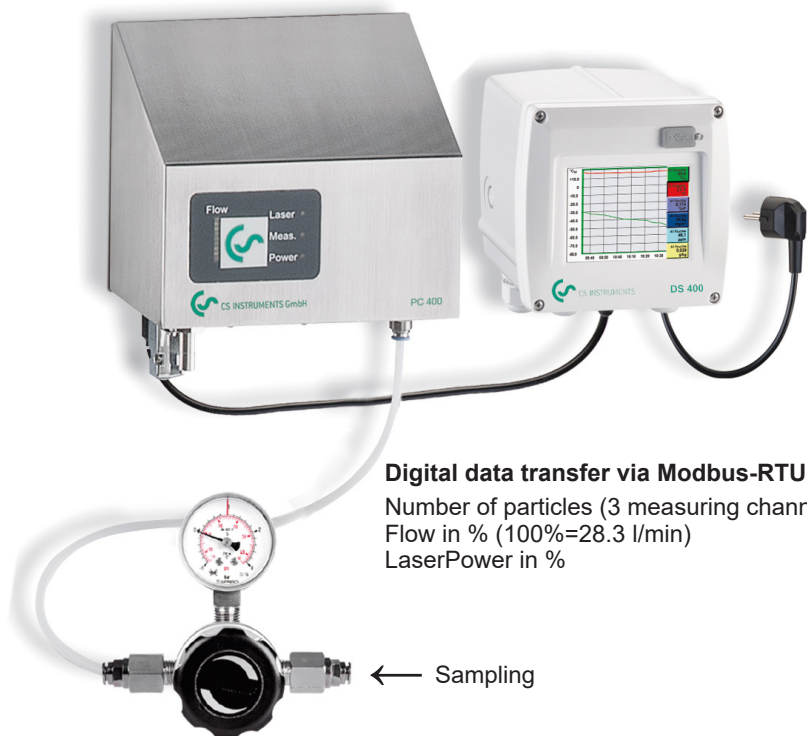

Digital data transfer via Modbus-RTU:

Number of particles (3 measuring channels)
Flow in % (100%=28.3 l/min)
LaserPower in %

The DS 400 shows all 3 measuring channels according to ISO 8573-1

Particle size 0.1...0.5 µm: Number of particles per m³

Particle size 0.5...1.0 µm: Number of particles per m³

Particle size 1.0...5.0 µm: Number of particles per m³

A1a	PC 400	0.1-0.5µ	1458 cts/m ³
A1b	PC 400	0.5-1.0µ	246 cts/m ³
A1c	PC 400	1.0-5.0µ	8 cts/m ³
Home		Setup	Alarm Lg.stop 10.01.2012 1 days, ... 22:34:33

Advantages at a glance:

- Highly precise, optical laser particle counter for use in compressed air and technical gases
- Highly precise optics for detecting the smallest particles up to 0.1 µm and therefore suitable for monitoring the compressed air class 1 according to ISO 8573-1
- The flow rate of 28.3 l/min (1 cfm) is 10 times higher than that of the particle counters generally available on the market (usually 2.83 l/min). Advantage: Counts the smallest particles with high counting accuracy at the same time
- Due to the digital data transfer (Modbus-RTU) to the chart recorders DS 400 or DS 500, 3 measuring channels can be transferred at the same time (without any faults due to check sum)
- The class 1 filter which is included in the scope of delivery can be used for on-site calibration at any time. Contaminations on the optics can therefore be quickly detected or eliminated.

Advantages of the DS 400

- Data logger for long-term monitoring
- Display shows trend curves (online and history curves available)
- Zoom function directly on the touch screen
- Integrated Ethernet interface (Modbus/TCP) and RS 485 interface (Modbus-RTU) for data transfer to superordinate controls
- 2 alarm relays (changeover contact 230 VAC, 3A) – threshold values freely adjustable
- Easy operation via 3.5" touchscreen

TECHNICAL DATA PC 400

Measured medium:	Compressed air (free from aggressive, corrosive, acid, toxic, flammable and oxidising components) as well as gas types like N ₂ , O ₂ , CO ₂ . Further gas types on request
Field of application:	In case of compressed air after filtration In case of gases / pure gases also without filtration
Parameter:	Number of particles per m ³ (relative to expanded air: 20 °C, 1000 hPa) Size channels for the PC 400 0.1 µm: Particle size 0.1...0.5 µm: Number of particles per m ³ Particle size 0.5...1.0 µm: Number of particles per m ³ Particle size 1.0...5.0 µm: Number of particles per m ³ Size channels for the PC 400 0.3 µm: Particle size 0.3...0.5 µm: Number of particles per m ³ Particle size 0.5...1.0 µm: Number of particles per m ³ Particle size 1.0...5.0 µm: Number of particles per m ³
Operating pressure:	Max. input pressure on the pressure reducer: 40 bar
Humidity of measured gas:	<= 90% rel. humidity, pressure dew point max. 10 °C, non-condensable humidity
Ambient temperature:	5...40 °C
Temperature of the measured medium:	0...40 °C
Compressed air connection:	6 mm PTFE-hose incl. quick coupling
Flow rate:	28.3 l/min (1 cfm)
Interface:	RS 485 (Modbus-RTU)
Light source:	Laser diode
Power supply:	24 VDC, 300 mA
Dimensions:	150 x 200 x 300 mm
Weight:	8 kg
Housing:	Stainless steel

Stationary solution with particle counter PC 400 and DS 400



DESCRIPTION	ORDER NO.
PC 400 particle counter up to 0.1 µm for compressed air and gases, incl. pressure reducer and calibration certificate	0699 0040
Connection cable for probes 5 m, with open ends	0553 0108
DS 400 chart recorder with graphic display and touch screen operation	0500 4000 D
Option:	
Integrated data logger for 100 million measured values	Z500 4002
Integrated Ethernet and RS 485 interface	Z500 4004
CS Basic - data evaluation in graphic and table form - readout of the measured data via USB or Ethernet. License for 2 working places	0554 8040
As an alternative to PC 400 up to 0.1 µm:	0699 0041
PC 400 particle counter up to 0.3 µm for compressed air and gases, incl. pressure reducer and calibration certificate	

Mobile solution with particle counter PC 400 in a service case and DS 500 mobile



DESCRIPTION	ORDER NO.
PC 400 particle counter up to 0.1 µm for compressed air and gases incl. pressure reducer and calibration certificate in a service case	0699 0042
Connection cable to portable devices, ODU/ M12, 5 m	0553 1503
Chart recorder DS 500 mobile, 4 sensor inputs	0500 5012
CS Basic - data evaluation in graphic and table form - readout of the measured data via USB or Ethernet. License for 2 working places	0554 8040
As an alternative to PC 400 up to 0.1 µm:	0699 0043
PC 400 particle counter up to 0.3 µm for compressed air and gases incl. pressure reducer and calibration certificate in a service case	

Re-calibration and accessories particle counter PC 400





DESCRIPTION	ORDER NO.
Re-calibration particle counter PC 400 incl. certificate	0699 3304
CS Service Software incl. PC connection set for PC 400	0554 2009

UltraCam LD 500/510 – Visualises the leaks directly in the image





- 

Enormous time saving compared to classic leak detectors
- 

30 MEMS microphones create the image of the leaks
- 

Brightness sensor activates LEDs in dark surroundings
- 

Available as an upgrade for LD 500/510
- 

NEW: Multi-user capable through cloud solution
- 

NEW: Unique laser distance measurement for automatic cost determination
- 

Find out your leakage rate (l/min or cfm) and potential savings (€ /year). Currency can be set as required
- 

Photograph leaking parts
- 

Paperless documentation. Enter everything into the device on site: Define the leakage location as well as the remedial measures and spare parts required
- 

Create a report in accordance with ISO 50001
- 

Fatigue-free work – ergonomic, one-hand operation – low weight

The LD 500 meets the requirements of class 1 instruments for the "Standard Test Method for Leaks Using Ultrasonic" (ASTM Int. - E1002-05)

Display and function in detail



The UltraCam LD 500/510 uses 30 MEMS microphones to calculate and visualise the ultrasound image. In addition, the device makes inaudible ultrasound audible.

Advantage over the **classic leak detectors**:

Visual representation of the leakage in the live image, even in noisy environments during production

To **determine the leakage rate**, the user aims the laser directly at the leakage. Leakage, laser and red circle must be on top of each other in the image. Then, the **leakage rate in l/min or cfm** and the **costs in €/year** are determined exactly. The distance is measured automatically.



DESCRIPTION	ORDER NO.
Set UltraCam with leak detector LD 500:	0601 0205
LD 500 leak detector with UltraCam, integrated camera, 30 ultrasonic microphones for visualisation of the leakage on the screen, incl. 100 leak tags	0560 0205
Transport case	0554 0106
Sound-proof headset	0554 0104
Focus tube with focus tip	0530 0104
AC adapter plug	0554 0009
Spiral cable for connecting the ultrasonic sensor, length 2m (extended)	020001402
Holster with shoulder strap for LD 500/510	020001795



DESCRIPTION	ORDER NO.
Set UltraCam with leak detector LD 510:	0601 0206
LD 510 leak detector with UltraCam, integrated camera, 30 ultrasonic microphones for visualisation of the leakage on the screen, incl. 100 leak tags	0560 0206
Transport case	0554 0106
Sound-proof headset	0554 0104
Focus tube with focus tip	0530 0104
AC adapter plug	0554 0009
Spiral cable for connecting the ultrasonic sensor, length 2m (extended)	020001402
Holster with shoulder strap for LD 500/510	020001795

Reporting software see page 137
For further accessories, refer to pages 138-139

LD 500/510 – Leak detector with camera - Shows leakage rate in l/min and cost in €



The LD 500 meets the requirements of class I instruments for the "Standard Test Method for Leaks Using Ultrasonic" (ASTM Int. – E1002-05)



NEW: Multi-user capable through cloud solution



NEW: Unique laser distance measurement for automatic cost determination



Find out your leakage rate (l/min or cfm) and potential savings (€ /year). Currency can be set as required



Find the smallest leaks at large distances



NEW: Automatic sensor detection



Auto level: Automatically adapts the sensitivity to the environment and reliably eliminates ambient noise



Photograph leaking parts



Paperless documentation. Enter everything into the device on site: Define the leakage location as well as the remedial measures and spare parts required



Transmit the leakage data via USB to your desktop software



Create a report in accordance with ISO 50001



9 hours of continuous operation possible



Fatigue-free work – ergonomic, one-hand operation – low weight

FINDING LEAKS PAYS OFF:

Sample calculation for a medium-sized company:

Approx. 25% of compressed air is lost due to leaks
 Installed compressor capacity 150 kW(el) x 6000 OpHrs x € 0.24 /kWh
 Annual electricity costs: **€ 216.000**

25% leakage cost: 54.000 € per year!



Display and function in detail

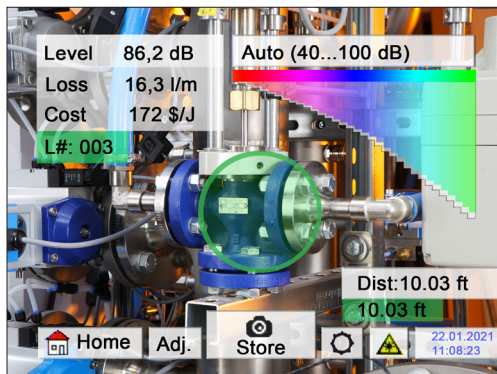

Search for leaks

The ultrasound, which is inaudible to the human ear, is made audible via headphones. Loud ambient noises are faded out.

The device indicates the leakage rate in (l/min or cfm) and the savings potential in (€ /year) on the display. Currency can be set as required. This data is saved together with the photo.

With the LD 500/510, the smallest leaks, even over long distances (0.1 l/min corresponds to approx. 1 € p.a.) can also be tracked and documented.

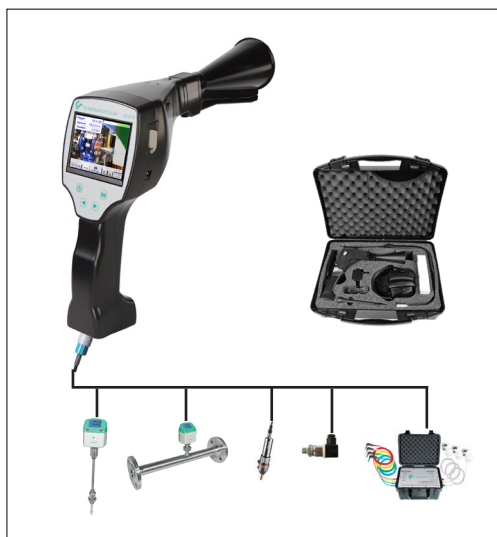

DESCRIPTION	ORDER NO.
LD 500 set consisting of:	0601 0105
LD 500 leak detector with acoustic trumpet and integrated camera, 100 leak tags for marking the leaks on site	0560 0105
NEW: Integrated laser distance measurement	Z554 5000
Transport case	0554 0106
Sound-proof headset	0554 0104
Focus tube with focus tip	0530 0104
AC adapter plug	0554 0009
Spiral cable for connecting the ultrasonic sensor, length 2m (extended)	020001402
Holster with shoulder strap for LD 500/510	020001795

DESCRIPTION	ORDER NO.
LD 510 set consisting of:	0601 0106
LD 510 leak detector incl. acoustic trumpet, with integrated camera and additional input for external sensors, 100 leak tags for marking the leaks on site	0560 0106
NEW: Integrated laser distance measurement	Z554 5000
Transport case	0554 0106
Sound-proof headset	0554 0104
Focus tube with focus tip	0530 0104
AC adapter plug	0554 0009
Spiral cable for connecting the ultrasonic sensor, length 2m (extended)	020001402
Holster with shoulder strap for LD 500/510	020001795

Easy documentation in the LD 500 / UltraCam LD 500 directly on site

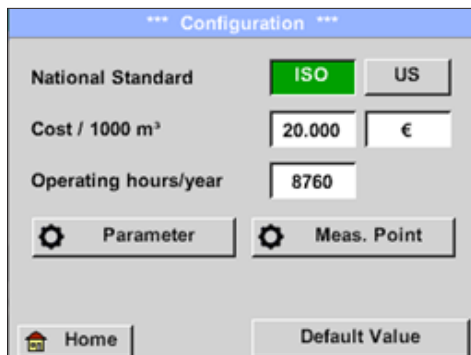

*** Configuration ***

National Standard: **ISO** | US

Cost / 1000 m³: 20.000 | €

Operating hours/year: 8760

Parameter | Meas. Point

Home | Default Value

Entering the compressed air costs in the unit

Depending on the electricity costs, the costs per 1000 m³ (or per 1000 cf) can be freely entered in any currency

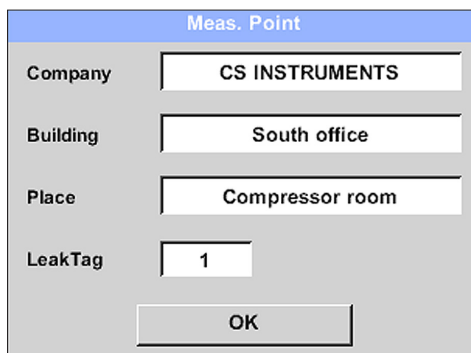

Meas. Point

Company: CS INSTRUMENTS

Building: South office

Place: Compressor room

LeakTag: 1

OK

Define the location

The location of each leak can be stored:
Company / building / location

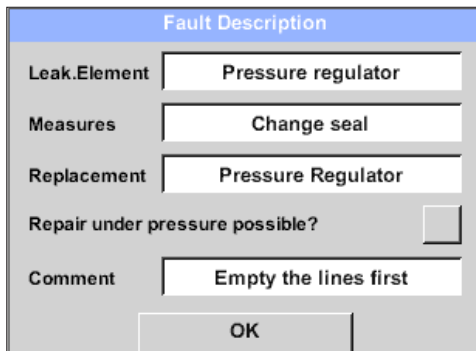

Fault Description

Leak.Element: Pressure regulator

Measures: Change seal

Replacement: Pressure Regulator

Repair under pressure possible?

Comment: Empty the lines first

OK

Remedy the leak

Efficiency and clarity also for elimination of leaks. Definition of the necessary spare parts and maintenance work already on site.

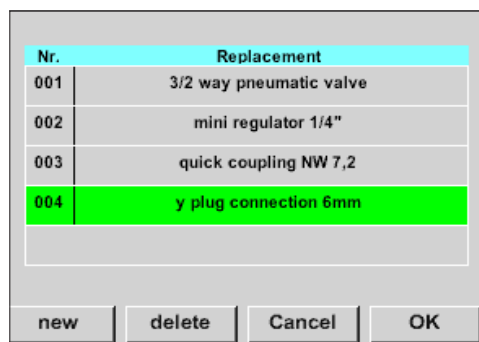

Nr.	Replacement
001	3/2 way pneumatic valve
002	mini regulator 1/4"
003	quick coupling NW 7,2
004	y plug connection 6mm

new | delete | Cancel | OK

Spare parts list in the device

The software can be used to transfer a custom spare parts list to the device. The device offers an intelligent search function with auto-complete feature. The list with the required spare parts can be exported from the CS Leak Reporter software.

Use the reporting software to quickly and efficiently produce an ISO 50001 report



CS Leak Reporter – cloud solution



Ideal for leak detection service providers and for companies/major corporations with multiple locations.

- Each “user” in the leakage search team can be assigned a role (e.g. leakage search, leakage repair, monitoring, checking for success)
- Access rights to individual or all projects can be assigned individually to each user
- The browser-based software ensures a common database in real time and paperless documentation



CS Leak Reporter – PC solution

Creates detailed ISO 50001 reports. Provides an illustrated overview of the leaks found and their savings potential. Measures for elimination, including status display, can be defined for every leak – license for two computers

Leakage Report	Start: 15/04/2019	End: 25/04/2019	Duration: 10 day(s)
Contact details:			
Company:	Acme	Auditor:	John Sample
Address:	...		1 Sample St., 12345 Sampletown
E-mail:	johnacme@sample.com		j.sample@acme.com
Phone:	...		+49 1234 567890
Logo:			
Project master data:			
Import date:		CO ₂ emissions:	0.527 kg/kWh
Cost calculation basis:	Energy costs (70%)	Specific output:	0.12 kWh/m ³
Compressed air costs:	21.6 €/1000 m ³	Electricity price:	0.18 €/kWh
Operating hours per year:	4350 h		
Results:			
Number of leaks:	141	Number remedied:	1
Total leakage amount:	718.126 ltr/min	Leakage amount saved:	3.468 ltr/min
Total costs per year:	4,048.49 €	Costs saved per year:	19.55 €
Total CO ₂ per year:	11.91 tonnes	CO ₂ saved per year:	0.06 tonnes

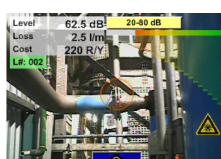
	Leak tag:	1	
	Building – location	COMPRESSOR ROOM 1	Repair under pressure possible? - No
	Date and time:	15/04/2019 12:06:03	Error: Ball valve defective
	Leakage rate:	< 1.395 ltr/min	Spare part: 1/2" ball valve
	Costs per year:	< 7.86 €	Action: Replace
	Total CO₂ per year:	0.02 tonnes	Note: -
	Priority:	Low	Status: Open
	Comment:	Replace ball valve	Remedied on: -
	Remedied by:	-	Remedied by: -
	Leak tag:	2	
	Building – location		Repair under pressure possible? - No
	Date and time:	15/04/2019 12:08:19	Error: Flange leaking
	Leakage rate:	2.519 ltr/min	Spare part: DN 100 flange seal
	Costs per year:	14.2 €	Action: Reestablish seal
	Total CO₂ per year:	0.04 tonnes	Note: -
	Priority:	High	Status: Done
	Comment:	Reestablish flange seal	Remedied on: 16/04/2019
	Remedied by:	-	Remedied by: AM

Accessories included in the set:



Headset

The noise-proof headset enables leak detection even in an extremely loud environment. The ambient noise is faded out, and the leakage (inaudible ultrasonic sound) is transformed into an audible signal



Holster with shoulder strap

For the LD 500/510, enables ergonomic and safe work



Focus tube with focus tip

For pinpoint detection of the smallest leaks in confined spaces

Professional accessory – parabolic mirror

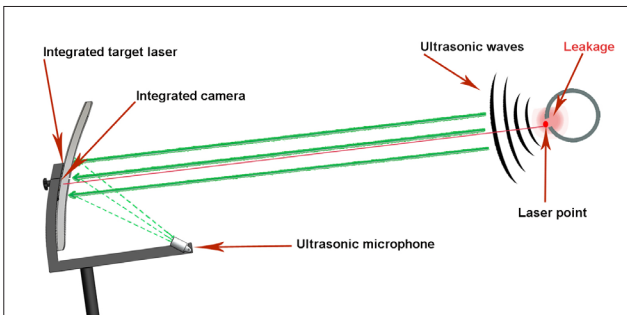

By focusing the ultrasonic waves in the parabolic mirror, even the smallest leaks of 0.8 l/min (approx. € 8 p.a.) can be located with pinpoint precision (± 15 cm) at a distance of up to 10 to 15 m.

The shape of the parabolic mirror ensures that only ultrasonic waves of the targeted leak are evaluated. Background noise is reduced to a minimum.

Accessories



DESCRIPTION

Gooseneck for leak detection at sites which are difficult to access (length 600 mm)

ORDER NO.

0530 0105

Gooseneck for leak detection at sites which are difficult to access (length 1500 mm)

0530 0108

Gooseneck High Sensitivity for leak detection on vacuum systems and for leak testing (length: 600 mm)

0530 0110



DESCRIPTION

Parabolic mirror with laser distance measurement for leak detection in long distances, incl. transport case

ORDER NO.

0530 0206

Parabolic mirror for leak detection at long distances, incl. transport case

0530 0106



DESCRIPTION

Ultrasonic tone generator for leak testing. A handy ultrasonic tone generator is available for detecting leaks in systems that are not under pressure. The transmitter is positioned so that the sound can enter the pipe system. The ultrasonic signal penetrates the smallest openings, which can then be detected with the LD 500

ORDER NO.

0554 0103

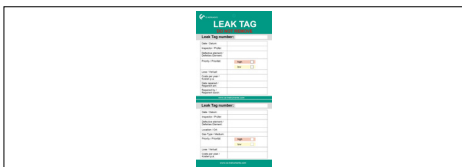

DESCRIPTION

500 leak tags for marking the leaks on site

ORDER NO.

0530 0107



DESCRIPTION

UltraCam – funnel with integrated camera, 30 ultrasonic microphones for visualisation of leakages – for retrofitting to existing LD 500 / LD 510

ORDER NO.

Z554 5500

Software



DESCRIPTION	ORDER NO.
CS Leak Reporter V2 Creates detailed ISO 50001 reports. Provides an illustrated overview of the leaks found and their savings potential. Measures for elimination, including status display, can be defined for every leak – license for two computers New functions: - Simple spare parts management - Histogram functions for documenting continuous improvement in accordance with ISO 50001 on the company or building level	0554 0205



DESCRIPTION	ORDER NO.
CS Leak Reporter V2 – additional licence for one computer	Z554 0205CS



DESCRIPTION	ORDER NO.
CS Leak Reporter – cloud solution Basic package: Browser-based access to the CS Cloud. Advantages: - Common database of all users in real time. - Cross-location work in a team - Paperless documentation. - Unlimited number of guest logins (read-only rights) can be set up. Only available in combination with at least one CS Cloud (0554 0306) user licence.	0554 0305



DESCRIPTION	ORDER NO.
User licence – CS Cloud 1 user / 12 months for CS Leak Reporter Cloud solution use. Term extension - 1 user / 12 months for CS Leak Reporter Cloud solution use.	0554 0306 0554 0307

LD 500/510 calibration

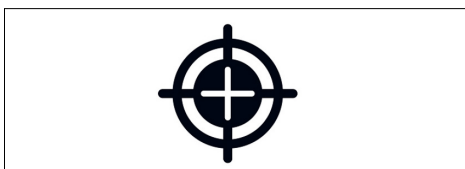

DESCRIPTION	ORDER NO.
LD 500/LD 510 re-calibration / UltraCam LD 500/510	0560 3333

Additional sensors / accessories for connection to LD 510

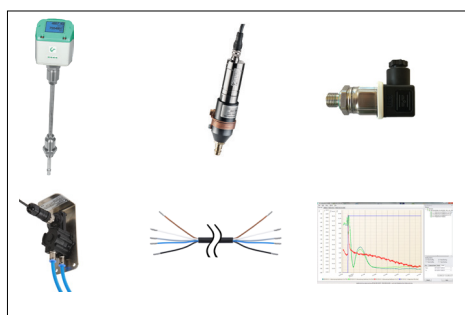

DESCRIPTION	ORDER NO.
FA 510 dew point sensor for mobile devices, -80...+20 °Ctd incl. mobile measuring chamber, 5 m connection cable and perforated protection cap	0699 1510
VA 500 flow probe, max. version (185 m/s), probe length 220 mm, incl. 5 m connection cable	0695 1124
Standard pressure probe CS 16, 0...16 bar, ± 1% accuracy of f.s.	0694 1886
Differential pressure probe 1.6 bar diff.	0694 3561
Connection cable for pressure, temperature or external sensors on mobile instruments, 5 m	0553 0501
CS Basic – data evaluation in graphic and table form – readout of the measured data via USB or Ethernet. License for two workstations	0554 8040

Calculation

Costs per year						
Pressure	Size of leak – diameter (mm)					
	0.5 mm	1.0 mm	1.5 mm	2.0 mm	2.5 mm	3.0 mm
3 bar	€ 90	€ 361	€ 812	€ 1,444	€ 2,256	€ 3,248
4 bar	€ 113	€ 451	€ 1,015	€ 1,805	€ 2,820	€ 4,061
5 bar	€ 135	€ 541	€ 1,218	€ 2,166	€ 3,384	€ 4,873
6 bar	€ 158	€ 632	€ 1,421	€ 2,527	€ 3,948	€ 5,685
7 bar	€ 180	€ 722	€ 1,624	€ 2,888	€ 4,512	€ 6,497
8 bar	€ 203	€ 812	€ 1,827	€ 3,248	€ 5,076	€ 7,309

Table: Leakage costs in one year with 24-hour operation 365 days per year calculated with compressed air costs of 1.9 ct/Nm³.

TECHNICAL DATA OF THE LD 500 / LD 510

Operating frequency:	40 kHz ± 2 kHz
Connections:	3.5 mm stereo jack for headset, power supply socket for connecting an external charger
Laser:	Wavelength: 630...660 nm Output power: < 1 mW (laser class 2)
Display:	3.5" touch screen
Interface:	USB interface
Data logger:	16 GB SD memory card (100 million values)
Power supply:	Internal rechargeable Li-Ion batteries, approx. 9 h continuous operation, 4 h charging time
Operating temperature:	-5...+50 °C
EMC:	DIN EN 61326
Auto level:	Automatically adapts the sensitivity to the environment and reliably eliminates ambient noise
Sensitivity:	min: 0.1 l/min at 6 bar, 5 m distance, approx. € 1/year of compressed air costs
Weight without headset:	540 grams

TECHNICAL DATA OF EXTERNAL SENSOR INPUT (LD 510 ONLY)

Measuring range:	See external CS sensors
Accuracy:	See external CS sensors
Power supply:	Output voltage: 24 VDC ± 10% Output current: 120 mA in continuous operation

Notice

Leak detector LD 450

If gases escape through leaks in pressurized pipe systems (e.g. non-tight screwed connections, corruptions and so on), ultrasonic noises are generated. By means of LD 450, even the smallest leakages which cannot be heard by the human ear and which are not visible due to their size can be detected even from distances of

several meters. LD 450 transforms the inaudible signals into a frequency which can be identified by human beings. By means of the comfortable sound-proof headset, these noises can be detected even in extremely noisy environments. The LD 450 leak detector is the advancement of the proven LD 300 and LD 400 and it impresses with its

significantly refined sensor technology and its improved support in the tracing of leaks. By means of the integrated laser pointer, which serves for target heading, the leak can be localised more accurately.

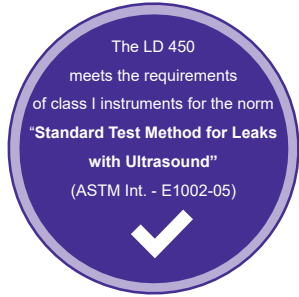

Applications

Leak detection on:

- compressed air, gas and vacuum systems
- Door seals

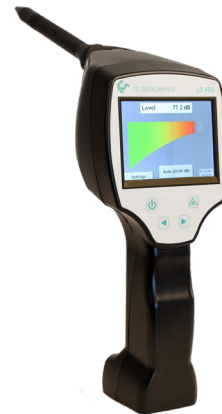

LD 450 with straightening tube and straightening tip for accurate detection.



Acoustic trumpet

Sound-proof headset:

Enables leak detection in an extremely loud environment

Costs per year

Pressure	Size of leakage - diameter (mm)					
	0.5 mm	1.0 mm	1.5 mm	2.0 mm	2.5 mm	3.0 mm
3 bar	€90	€361	€812	€1,444	€2,256	€3,248
4 bar	€113	€451	€1,015	€1,805	€2,820	€4,061
5 bar	€135	€541	€1,218	€2,166	€3,384	€4,873
6 bar	€158	€632	€1,421	€2,527	€3,948	€5,685
7 bar	€180	€722	€1,624	€2,888	€4,512	€6,497
8 bar	€203	€812	€1,827	€3,248	€5,076	€7,309

Table: Leakage costs within one year in case of operation 24 h/365 days, calculated with compressed air costs of 1.9 ct/Nm³.

Through the use of a specially designed acoustic trumpet, a better bundling of the sound waves is achieved. This trumpet acts like a directional microphone, which bundles ultrasonic waves and thus improves the acoustic behavior. Due to the special design of the acoustic

trumpet, the use of the laser pointer is not hindered.

Leak test:

A handy ultrasonic transmitter is available for detecting leaks in pressureless systems. The transmitter is positioned so that the sound can enter the pipe system. The ultrasonic signal penetrates the small-

est openings, which can then be detected with the LD 450.

Special features

- Robustness and low weight ensure fatigue-free use in industrial environments
- Improved detection of leakages with the acoustic trumpet
- Modern Li-Ion battery with high capacity, external charger
- Minimum operating time 10 h
- Easy operation via membrane keypad
- Adjustable sensitivity



LD 450 is available either as standalone device or in a complete set. The set includes a robust impact-proof transportation case which contains all necessary components and accessories.

DESCRIPTION	ORDER NO.
Set LD 450 consisting of:	
LD 450 leak detector for compressed air systems	0601 0204
Transport case	0560 0204
Sound-proof headset	0554 0106
Focus tube with focus tip	0554 0104
AC adapter plug	0530 0104
Acoustic trumpet	0554 0009
	0530 0109
Accessories not included in the set:	
Ultrasonic transmitter	0554 0103

TECHNICAL DATA LD 450

Operating frequency:	40 kHz ± 2 kHz
Connections:	3.5 mm stereo jack for headset. Power supply socket for connecting an external charger
Laser:	Wavelength: 630...660 nm Output power: < 1 mW (laser class 2)
Operating time:	>10 h
Charging time:	max. 4h
Operating temperature:	-5 °C to 50 °C
Storage temperature:	-20 °C to +60 °C



CS Basic

Data evaluation during mobile measurement:

With the CS Basic, the chart recorder DS 500/400 and all mobile devices with data logger can be read out. Depending on the device, data transfer is performed either via USB stick or Ethernet connection.

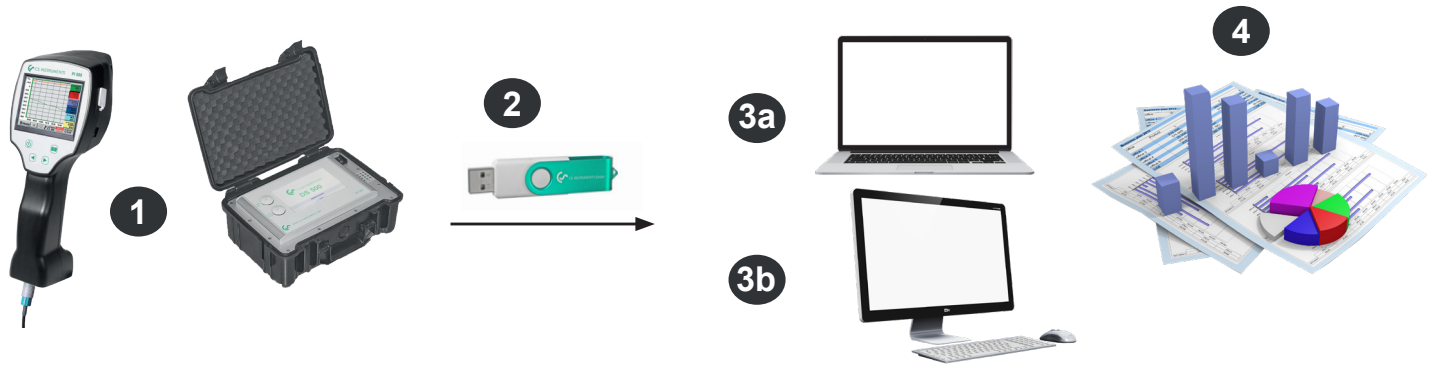

- 1** Mobile measurement at the customer. Measured data are saved in the data logger in the selected measuring cycle
- 2** Export of the data to USB stick
- 3a** Import of the measured data to the laptop directly on-site
- 3b** Import of the measured data to the computer in the office
- 4** Evaluation and print out of the measured data

Data evaluation for firmly installed chart recorders in the company:

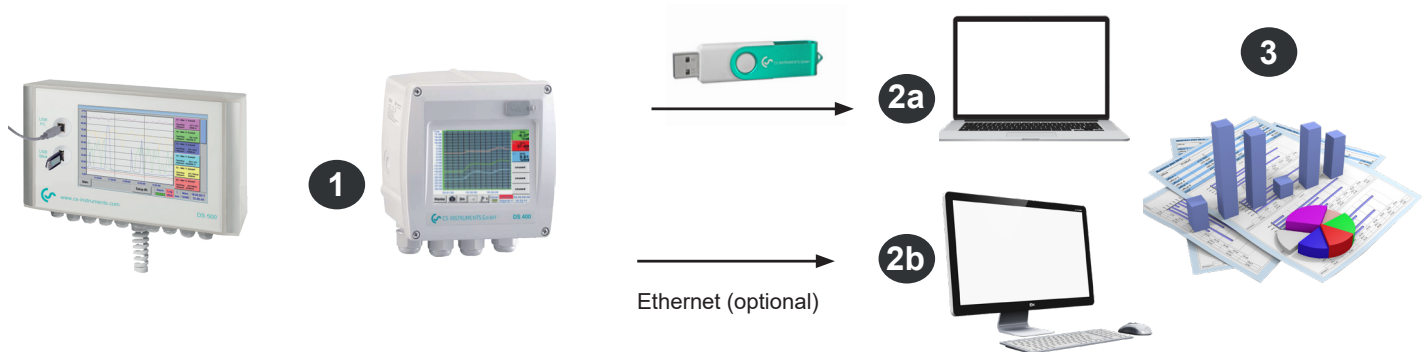

- 1** Chart recorder is firmly installed in the company. Measured data are saved in the data logger in the set measuring cycle.
- 2a** Transfer of the data via USB stick to the computer
- 2b** Readout of the logger data via the computer network (LAN) by means of CS Basic
- 3** Evaluation and print out of the measured data

DESCRIPTION	ORDER NO.
CS Basic – data evaluation graphically and in tabular form - reading of the measured data via USB or Ethernet, license for 2 workstations	0554 8040
Additional license for 1 further workplace	Z554 8040
Upgrade CS Soft Basic (0554 7040) to CS Basic (0554 8040). CAA module is no longer available. Please state old licence key when ordering	Z554 8041

CS Basic

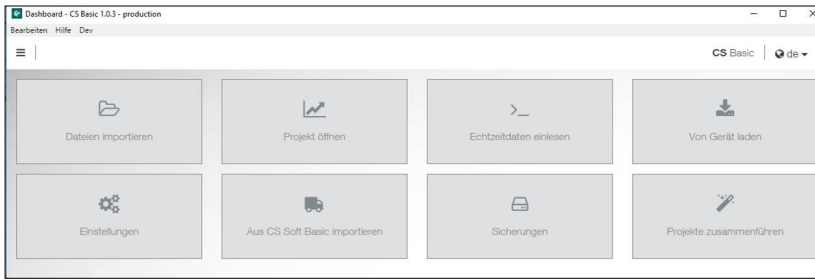

Intuitive operation

- All important functions can be retrieved via the dashboard.
- Global settings: Adjust units and change decimal places, store company name and logo
- Import real-time data: Establish Ethernet connection to CS logger or sensor. Trace real-time measured values in graphic and in table form
- Import from CS Soft Basic: Data migration from the previous version of CS Soft Basic
- Data backup: Backup of the projects and the database
- csv. export



Graphic evaluation

All measurement curves are indicated in colour. All necessary functions like free zoom, selection/deselection of single measurement curves, free selection of periods, scaling of the axes, selection of colours and so on are integrated:
This view can be saved as a PDF file and sent as an e-mail. Different data can be combined in a shared file.

Datum	Gerät	A2.1 Pressure A2a bar	B3.1 Dewpoint DewPoint °Ctd	B3.2 Rel.Humid. %	B3.3 Temperatur °C
27.01.17 13:52:18	0	9,6749	-50,6462	0,1534	20,2556
27.01.17 13:52:28	0	9,676	-51,4187	0,1394	20,2517
27.01.17 13:52:38	0	9,6769	-52,0952	0,128	20,2499
27.01.17 13:52:48	0	9,678	-52,791	0,1173	20,2479

Table view

All measuring points are listed with exact time interval. The desired measuring channels with the name of the measuring place can be selected via the diagram explorer.

Kanal	Durchschnitt	Minimum	Datum von Minimum	Maximum	Datum von Maximum
B3.2 Dewpoint - Rel.Humid. (%)	0.1094 %	0.0549 %	15.02.17 13:50:38	0.4118 %	13.02.17 14:30:08
B3.1 Dewpoint - DewPoint (°Ctd)	-53.2789 °Ctd	-57.9552 °Ctd	27.01.17 13:54:38	-41.6251 °Ctd	13.02.17 14:38:08
B3.3 Dewpoint - Temperatur (°C)	22.072 °C	20.1182 °C	27.01.17 13:59:58	28.0402 °C	14.02.17 08:25:38

Statistics

All required statistic data are visible at a glance. So the user can see very quickly which minimal or maximal measured values occurred when and for how long.

	Januar	Februar	März	April	Mai	Juni	Juli	August	September	Oktober	November	Dezember	Summe
A1.2 Verbrauch Halle 1 - A1b (m³)	1.958.827	2.078.325	2.215.062	2.368.484	2.514.612	2.666.480	2.826.483	3.002.938	3.169.484	3.318.642	3.491.661	3.659.617	
Bis (m³)	2.078.325	2.215.062	2.368.484	2.514.612	2.666.480	2.826.483	3.002.938	3.169.484	3.318.642	3.491.661	3.659.617	3.775.973	
Verbrauch (m³)	117.498	138.737	153.402	148.148	151.868	160.003	176.455	186.546	149.158	173.019	167.956	116.356	1.817.148
Kosten (€)	2.232,46	2.636,00	2.914,64	2.776,81	2.885,49	3.040,06	3.352,65	3.164,37	2.834,00	3.287,36	3.191,16	2.210,76	34.525,774
A1.1 Verbrauch Halle 1 - A1a (m³/h)													
Minimum	0	6,3	0	0	0	1,36	0	0	0	0	0	0	
Durchschnitt (m³/h)	157,6	205,98	205,6	202,54	203,52	221,66	236,5	223,25	206,67	232,19	232,67	155,99	
Maximum	1.060,36	527,02	736,39	1.154	662,43	618,27	617,9	636,36	931,66	642,96	689,77	2.410,71	

Flow evaluation

The software carries out flow analysis for all connected flow meters, optionally as a daily, weekly or monthly analysis.

CS Network

Energy monitoring for compressed air and gases in an enterprise

The CS Network is a client-server solution. The server software automatically collects the measured values of all chart recorders and sensors embedded in the company's computer network and stores them in a database. The evaluation/analysis of the measured data is carried out via the evaluation software (client) at any number of workstations.

- Display real-time data in individual dashboards
- Automatic reporting for consumption: Weekly, monthly, annually
- Automatic alarm by e-mail if limit value is exceeded or not reached
- Alarm history

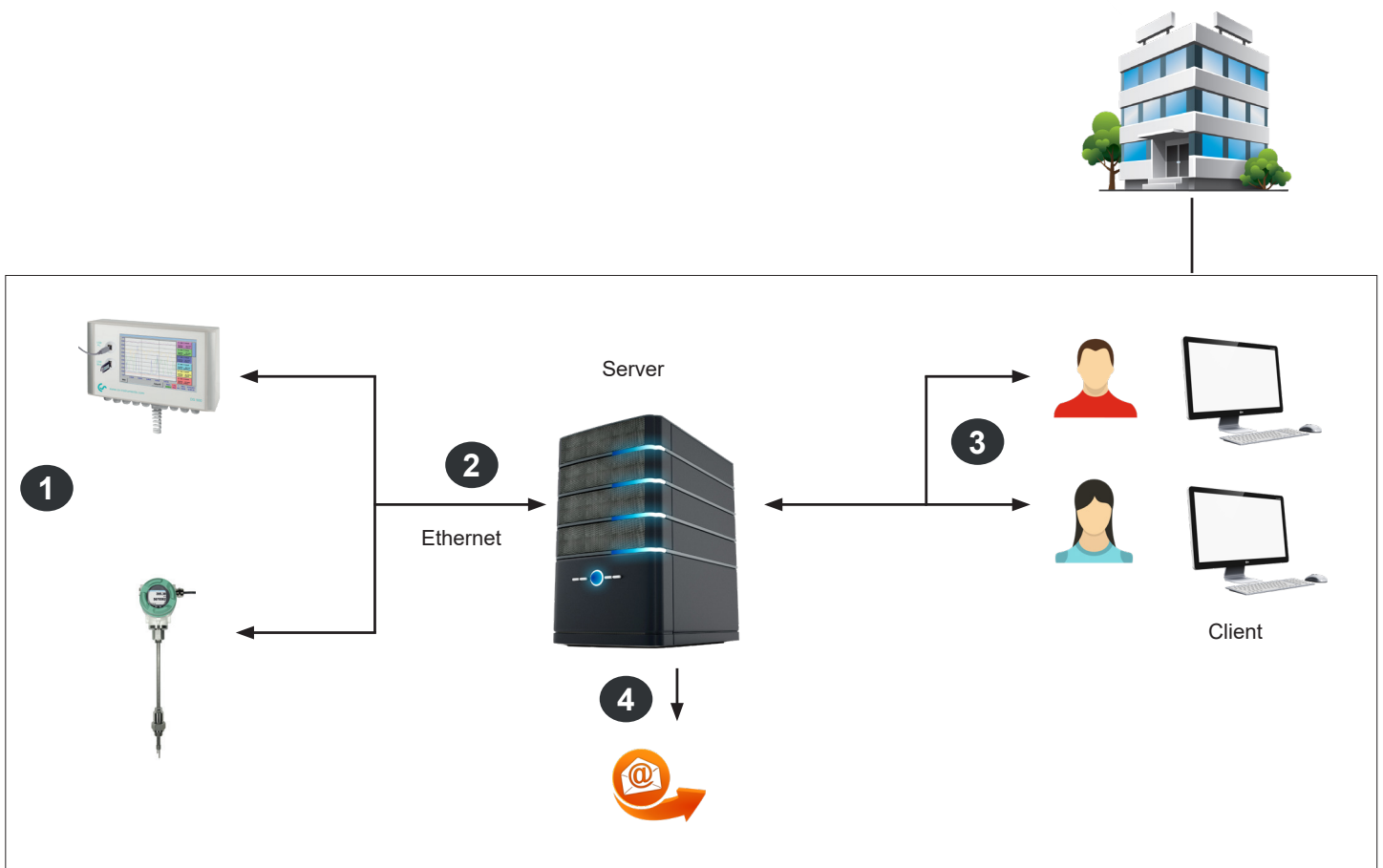

- 1** Single sensors with Ethernet connection or chart recorders with several sensors measure the compressed air and gas consumption of all departments/cost centres in an enterprise.
- 2** The CS Network (Server Installation) automatically collects the measured values of all CS chart recorders and CS sensors which are connected to the computer network in an enterprise and stores them in a database.
- 3** The evaluation/analysis of the measured data is carried out via the evaluation software (Client) at an unlimited number of workstations.
- 4** In case of an exceeding of the limit values (freely adjustable), there will be an automatic alarm via e-mail

CS Network

Example – Dashboards



Energy monitoring

Monitoring of consumption and leakage of the entire site, individual departments or systems

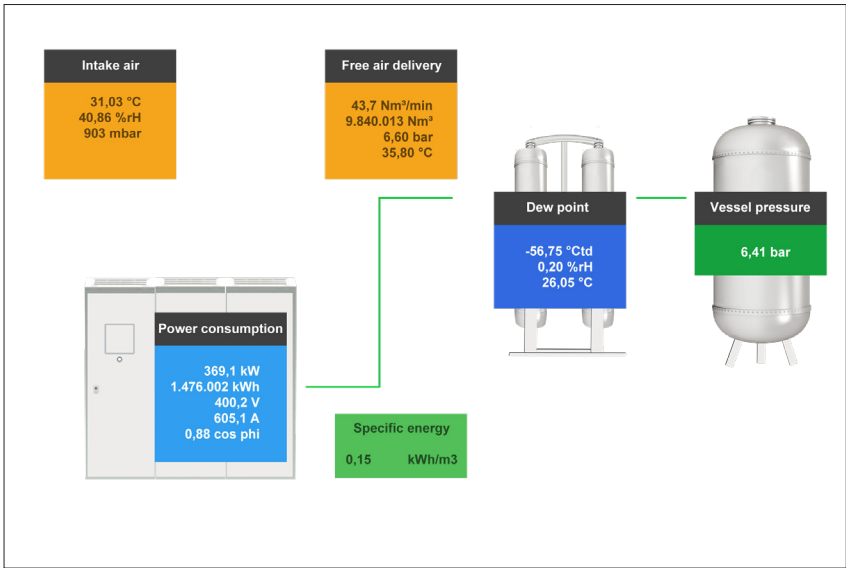

Compressor efficiency

Monitoring of the intake controls, power consumption and free air delivery of the compressors

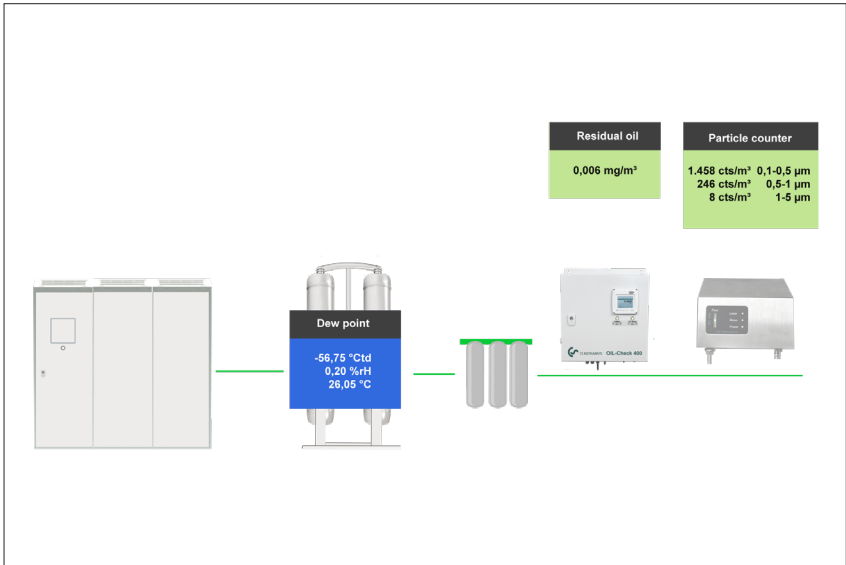

Quality monitoring

Monitoring of compressed air treatment and required ISO 8573-1 quality classes – particles, residual oil and dew point

CS Network

Evaluations

Channel	Unit	Description	Monday	Tuesday	Wednesday	Thursday	Friday	Saturday	Sunday	Total
Demobereich Vertrieb										
Frühschicht (06:00:00-14:00:00)										
Consumption compressed air Site 1 production - Tarif "Standardtarif" 00:00:00 - 23:59:59 : 5 € per m³										
m³		start count	7675.00	7865.00	8074.00	8271.00	8329.00	8329.00	8329.00	
m³		end count	7729.00	7935.00	8147.00	8329.00	8329.00	8329.00	8329.00	
m³		total	54.00	70.00	73.00	58.00	0.00	0.00	0.00	255.00
m³/h		average	8.5	8.7	9.1	7.3	0.0	0.0	0.0	5.6
m³/h		min	7.6	0.0	0.5	0.0	0.0	0.0	0.0	
m³/h		max	9.0	9.3	13.4	8.2	0.0	0.0	0.0	
€		costs	270.00	350.00	365.00	290.00	0.00	0.00	0.00	1275.00
Consumption compressor station - Tarif "Standardtarif" 00:00:00 - 23:59:59 : 5 € per Nm³										
Nm³		start count	26659.00	26667.00	26676.00	26788.00	26841.00	26841.00	26851.00	
Nm³		end count	26660.00	26670.00	26683.00	26835.00	26845.00	26845.00	26854.00	
Nm³		total	1.00	3.00	7.00	47.00	4.00	3.00	3.00	65.00
Nm³/h		average	0.4	0.4	1.0	6.0	0.4	0.4	0.4	1.4
Nm³/h		min	0.4	0.4	0.4	0.4	0.4	0.4	0.4	
Nm³/h		max	0.6	0.8	6.9	7.3	0.4	0.4	0.4	
€		costs	5.00	15.00	35.00	235.00	20.00	15.00	15.00	325.00

Weekly report

Have consumption reports created automatically and sent by e-mail. This way you always have an overview of your consumption and costs and have them under control. You can choose between monthly, weekly or annual reports. The comparison function allows you to compare different time periods so that you can recognise irregularities in your consumption, among other things..

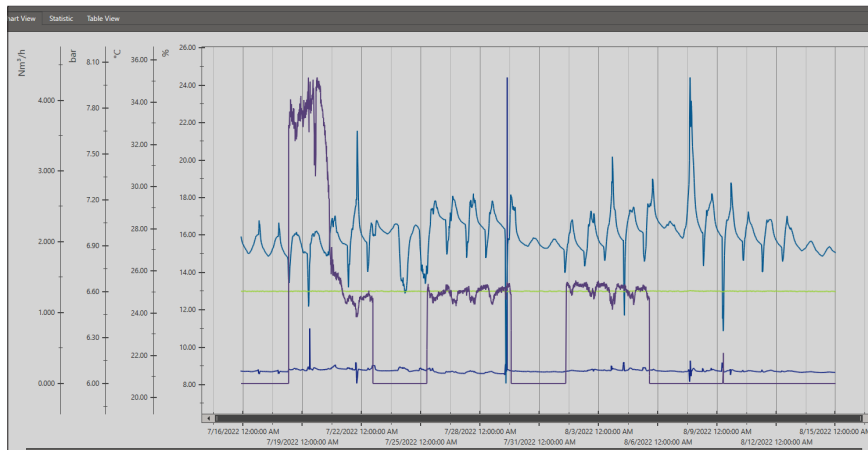

Graphic evaluation

All measurement curves are indicated in colour. All necessary functions like free zoom, selection/deselection of single measurement curves, free selection of periods, scaling of the axes, selection of colours and so on are integrated: Different data can be merged into one common file. This view can be saved as a PDF file and sent as a mail.

Time	Demobereich Vertrieb_DS 500 CS Network_A3b: RelHumid_ [%]	Demobereich Vertrieb_DS 500 CS Network_A3c: Temperatu_ [°C]	Demobereich Vertrieb_DS 500 CS Network_B1a: Druck_[bar]	Demobereich Vertrieb_DS 500 CS Network_B2a: Flow_[Nm³/h]
7/19/2022 3:57:00 PM	8.89	27.87	6.60	3.300
7/19/2022 4:06:00 PM	8.89	27.84	6.60	2.933
7/19/2022 4:15:00 PM	8.88	27.84	6.60	2.925
7/19/2022 4:24:00 PM	8.88	27.84	6.60	3.125
7/19/2022 4:33:00 PM	8.88	27.84	6.60	3.039
7/19/2022 4:42:00 PM	8.88	27.84	6.60	3.232
7/19/2022 4:51:00 PM	8.87	27.84	6.60	4.058
7/19/2022 5:00:00 PM	8.85	27.86	6.60	4.144
7/19/2022 5:09:00 PM	8.85	27.88	6.60	4.055
7/19/2022 5:18:00 PM	8.86	27.86	6.60	4.190
7/19/2022 5:27:00 PM	8.84	27.89	6.60	4.129

Table view

All measuring points are listed with exact time interval. The desired measuring channels with the name of the measuring place can be selected via the diagram explorer.

Area name: Demobereich Vertrieb						
Part name: DS 500 CS Network						
11	A3b: RelHumid	%	8.73	8.06	7/21/2022 7:06:00 PM	
12	A3c: Temperatu	°C	27.73	20.66	7/29/2022 7:42:00 AM	
13	B1a: Druck	bar	6.6	6.59	7/29/2022 7:51:00 AM	
14	B2a: Flow	Nm³/h	0.719	0	7/15/2022 9:39:00 PM	

Statistics

All required statistic data are visible at a glance. So the user can see very quickly which minimal or maximal measured values occurred when and for how long.

DESCRIPTION	ORDER NO.
CS Network – Energy monitoring with client/server solution (max. 20 measured values of different sensors/devices)	0554 8041
CS Network – Energy monitoring with client/server solution (max. 50 measured values of different sensors/devices)	0554 8042
CS Network – Energy monitoring with client/server solution (max. 100 measured values of different sensors/devices)	0554 8043
CS Network – Energy monitoring with client/server solution (max. 200 measured values of different sensors/devices)	0554 8044



Notes



Competitive differential pressure probe for testing on compressed air systems

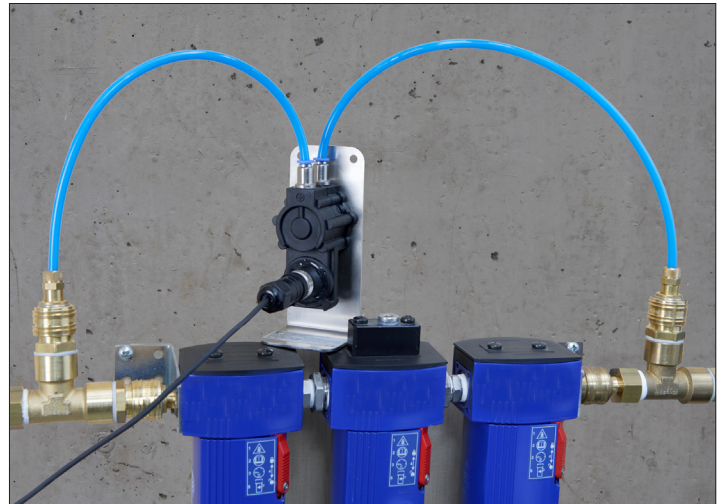

Typical application of the differential pressure sensor: connection with two PE hoses before and after the filter elements.

Requirements in practice:

- Timely replacement of the filter elements
- At a differential pressure of >350 mbar at the latest, the filter elements should be replaced (active carbon filters are excluded from this)

DESCRIPTION	ORDER NO.
Differential pressure probe 1.6 bar diff.	0694 3561
Connection cable for probes 5 m, with open ends	0553 0108
Connection cable for probes 10 m, with open ends	0553 0109
Connection cable for pressure, temperature or external sensors on mobile instruments, ODU / open ends, 5 m	0553 0501
Connection cable for pressure, temperature or external sensors on mobile instruments, 10 m	0553 0502

TECHNICAL DATA

Measuring range:	0 ... 1.6 bar difference
Max. system pressure:	10 bar
Max. overload capability two-sided:	15 bar
Max. one-sided overload capability:	
+ side	15 bar
- side	10 bar
Bursting pressure:	60 bar
Total error:	2.0% of the full scale
Output:	4 ... 20 mA two-wire
Power supply:	10 ... 30 V for output 4...20 mA
Ambient operating temperature:	-20 ... +80 °C
Connections:	2× G 1/8" female thread incl. plug-in coupling for 6 mm hose
Electrical connection:	Round plug M12 × 1

The longer a filter element is in use, the quicker the differential pressure is rising, and consequently the costs – see diagram below.

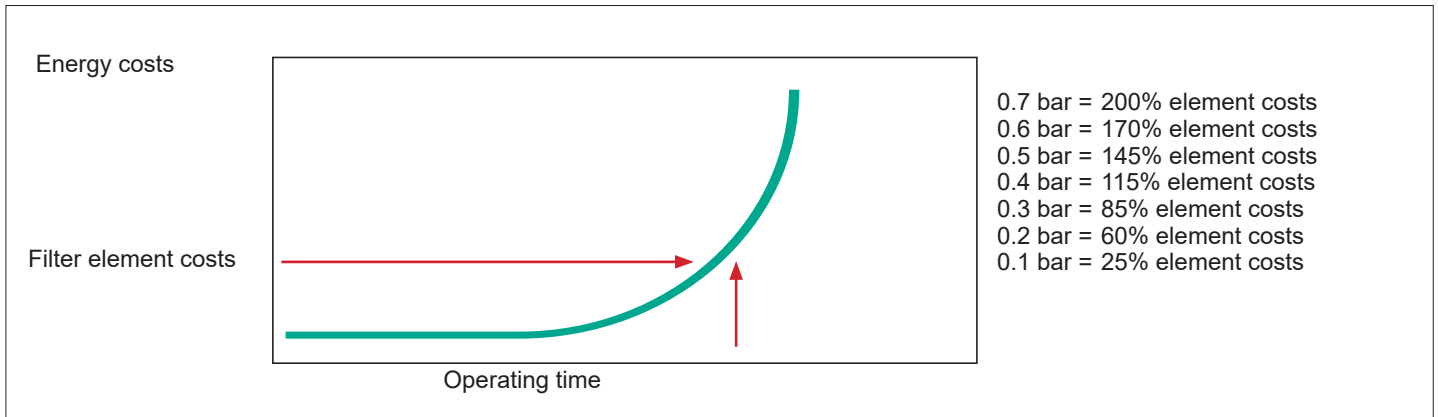
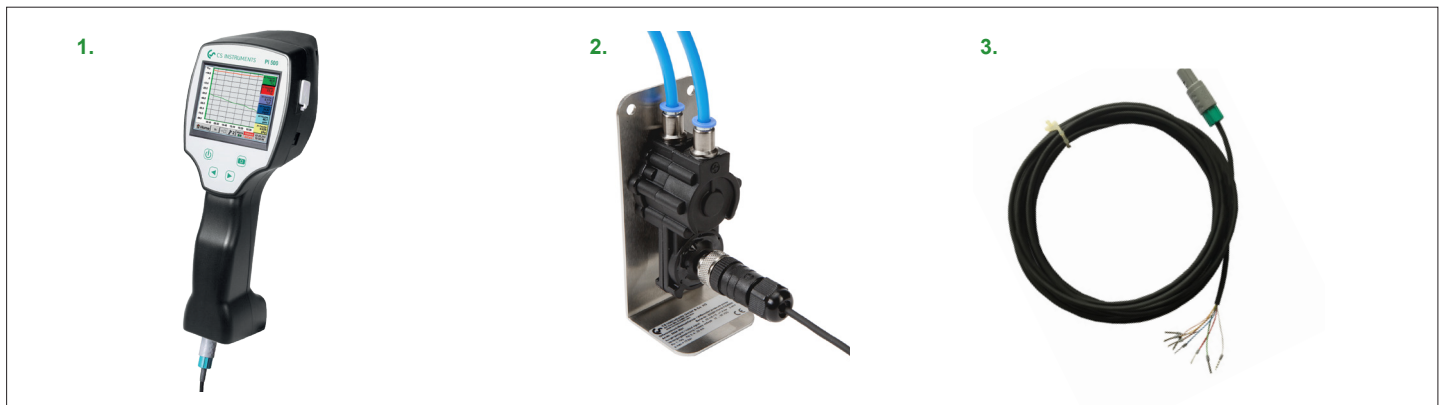

Fig.: Typical differential pressure process, energy costs in relation to filter element costs

PI 500 set for mobile measurement



- | | |
|---|-----------|
| 1. PI 500 portable handheld device with integrated data logger | 0560 0511 |
| 2. Differential pressure probe 1.6 bar diff. | 0694 3561 |
| 3. Connection cable for pressure, temperature or external sensors to mobile devices, ODU / open ends, 5 m | 0553 0501 |

DS 52 set for stationary measurement



- | | |
|--|-----------|
| 1. DS 52 LED process display in the wall housing | 0500 0009 |
| 2. Differential pressure probe 1.6 bar diff. | 0694 3561 |
| 3. Connection cable for probes 5 m, with open ends | 0553 0108 |



PTS 500 – Measures pressure and temperature in the process



Special features:

- 2 in 1 sensor: Pressure and temperature
- Wetted parts made of stainless steel for universal use in gases and liquids
- Easy integration into control systems, process control technology and energy management systems via digital interfaces
- Modbus-RTU, Ethernet or M-Bus interface
- Alarm relay – limit value adjustable via buttons (max 60 VDC, 0.5 A)
- Optional: 2 x 4...20 mA analogue output, 2 x alarm relays for pressure and temperature

Example order code PTS 500:

0694 7000_A1_B1_C1

Signal output option	
A1	1 x 4...20 mA analogue output (galvanically not isolated), alarm relay, RS 485 (Modbus-RTU)
A2	2 x 4...20 mA analogue output (galvanically not isolated), 2 x alarm relays, RS 485 (Modbus-RTU)
A3	Ethernet interface (Modbus/TCP), 1 x 4...20 mA analogue output (galvanically not isolated), RS 485 (Modbus-RTU)
A4	Ethernet interface PoE (Power over Ethernet) (Modbus/TCP), 1 x 4...20 mA analogue output (galvanically not isolated), RS 485 (Modbus-RTU)
A5	M-Bus, 1 x 4...20 mA analogue output (galvanically not isolated), alarm relay, RS 485 (Modbus-RTU)

Pressure measuring ranges	
B1	-1... 0 bar (-14.5...0 psi)
B2	0... 1.6 bar (0...23.2 psi)
B3	0... 10 bar (0...145 psi)
B4	0... 16 bar (0...232 psi)
B5	0... 50 bar (0...725 psi)

Process connections	
C1	G1/2"
C2	1/2" NPT

TECHNICAL DATA of PTS 500

Temperature measuring range:	-20...125°C
Accuracy:	± 1.0 °C (-10...+50°C)
Pressure measuring range:	See order code
Accuracy:	± 0.5% off f.s.(at 20°C)
Voltage supply:	18...36 VDC via SELV supply, 5W or Power over Ethernet (IEEE802.3af: Class 2 (3.84W - 6.49W))
Protection class of housing:	IP 65
Operating temperature:	-20...+125°C for pressure sensor
Ambient temperature:	-20...+60°C
Storage temperature:	-40...+80°C
Readable via Modbus:	Pressure [hPa, mbar, bar, psi,...] Temperature [°C, °F]
Signal output:	See order code

DESCRIPTION	ORDER NO.
PTS 500 sensor for measuring of pressure and temperature	0694 7000
Further accessories:	
Connection cable for probes 5 m with open ends	0553 0104
Connection cable for probes 10 m with open ends	0553 0105
Ethernet connection cable length 5 m, M12 plug x-coded (8 pin) to RJ 45 plug	0553 2503
Ethernet connection cable length 10 m, M12 plug x-coded (8 pin) to RJ 45 plug	0553 2504

DPS 16 - Digital Pressure probe



Features:

- Digital temperature compensation and non-linearity correction
- RS 485 interface (Modbus-RTU)

DIGITAL PRESSURE PROBE	± 1% ACCURACY	± 0,5% ACCURACY
Digital pressure probe DPS 16, 0...16 bar RS 485, G1/2"	0694 2886	0694 4555
Digital pressure probe DPS 16, 0...16 bar RS 485, NPT 1/2"	0694 3886	0694 5555

TECHNICAL DATE DPS 16	
Measuring range:	0...16 bar
Accuracy:	± 0.5% resp. ±1%
Long-term Stability:	±0.2% FS/year
Temperature:	-30°C...80°C
Protecting Rating:	IP65
Power supply:	11...28 VDC
Components in contact with media:	316 L
Process connection:	G 1/2" or 1/2" NPT

CS 16 - Pressure probe



Features:

- Welded measuring system with no seals
- 4...20 mA analogue output, 2-wire

PRESSURE PROBES WITH 4...20 mA ANALOGUE OUTPUT	± 1% ACCURACY	± 0,5% ACCURACY
Standard pressure probe CS 16, 0...16 bar	0694 1886	0694 3555
Standard pressure probe CS 40, 0...40 bar	0694 0356	0694 3930
Standard pressure probe CS 1.6, 0...1.6 bar abs.		0694 3550
Standard pressure probe CS 10, 0...10 bar	0694 3556	0694 3554
Standard pressure probe CS 100, 0...100 bar		0694 3557
Standard pressure probe CS 250, 0...250 bar		0694 3558
Standard pressure probe CS 400, 0...400 bar		0694 3559
Precision pressure probe CS -1...+15 bar, ± 0.5 % accuracy of. f.s.		0694 3553
Calibration certificate pressure, 5 calibration points for the whole measuring range		3200 0004

TECHNICAL DATE CS 16	
Measuring range:	-1...400 bar
Accuracy:	± 0.5% resp. ±1%
Long-term Stability:	±0.2% FS/year
Temperature:	-40°C...125°C
Protecting Rating:	IP65
Power supply:	8...30 VDC
Components in contact with media:	316 L, 304
Process connection:	G 1/4"



IAC 500– Measures ambient conditions in the room – Absolute pressure, room temperature, humidity



Special features:

- 3 in 1 sensor: absolute pressure, temperature and humidity in the room
- Modbus-RTU, Ethernet or M-Bus interface
- Alarm relay – limit value adjustable via buttons (max 60 VDC, 0.5 A)
- Optional: 2 x 4...20 mA analogue outputs, 2 x alarm relays, e.g., for dew point and temperature

Application:

- Monitoring the intake air of compressed air stations
- Monitoring of room air e.g. cold rooms, storage rooms or clean rooms

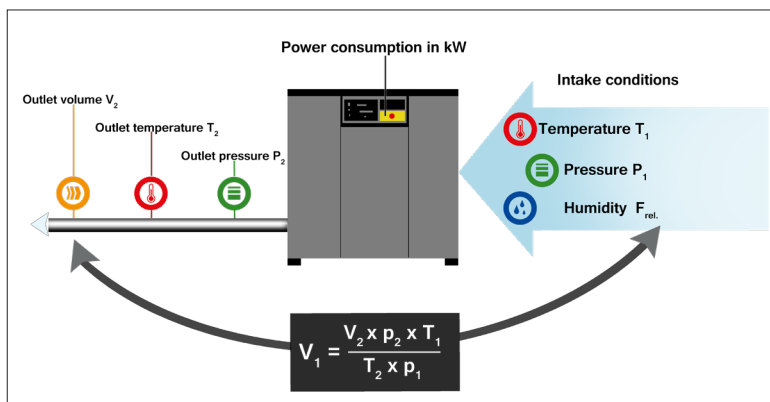

The delivery rate of compressors depends on the intake air.

The installation site and the climatic conditions must already be taken into account when designing compressed air stations.

Large temperature fluctuations, e.g. between day and night, lead to uneven compressed air flow.

Example order code IAC 500:

0604 1000_A1

Signal output option	
A1	1 x 4...20 mA analogue output (galvanically not isolated), alarm relay, RS 485 (Modbus-RTU)
A2	2 x 4...20 mA analogue output (galvanically not isolated), 2 x alarm relays, RS 485 (Modbus-RTU)
A3	Ethernet interface (Modbus/TCP), 1 x 4...20 mA analogue output (galvanically not isolated), RS 485 (Modbus-RTU)
A4	Ethernet interface PoE (Power over Ethernet) (Modbus/TCP), 1 x 4...20 mA analogue output (galvanically not isolated), RS 485 (Modbus-RTU)
A5	M-Bus, 1 x 4...20 mA analogue output (galvanically not isolated), alarm relay, RS 485 (Modbus-RTU)

DESCRIPTION	ORDER NO.
IAC 500 sensor for measuring ambient conditions (absolute pressure, temperature, rel. humidity), incl. wall bracket	0604 1000
Further accessories:	
Connection cable for probes 5 m with open ends	0553 0104
Connection cable for probes 10 m with open ends	0553 0105
Ethernet connection cable length 5 m, M12 plug x-coded (8 pin) to RJ 45 plug	0553 2503
Ethernet connection cable length 10 m, M12 plug x-coded (8 pin) to RJ 45 plug	0553 2504

TECHNICAL DATA of IAC 500

Temperature	
Measuring range:	-20...+60°C,
Accuracy:	± 1.0 K (0...60°C) ± 1.25 K (-20...0°C)
Rel. humidity	
Measuring range:	5...95% rF
Accuracy:	± 3%
Absolute pressure	
measuring range:	300...1100 hPa (abs)
Accuracy	±1.7 hPa
Voltage supply:	24 VDC (18...30 VDC via SELV supply) or Power over Ethernet (IEEE802.3af: Class 2 (3.84W - 6.49W))
Protection class of housing:	IP 65
Operating temperature:	-20...+60°C
Ambient temperature:	-20...+60°C
Storage temperature:	-40...+80°C
Readable via Modbus:	Absolute pressure [hPa, mbar, bar, psi,...], dew point [°Ctd, °Ftd], temperature [°C, °F], rel. humidity [%RH], abs. humidity [g/m³].



DS 52 - LED process display

In wall housing for 0 (4)...20 mA standard signals



The DS 52 has 2 potential-free alarm contacts (changeover contacts) which can be charged with a maximum of 230 VAC, 3 A. The alarm thresholds are freely adjustable with the keys. The display is supplied with 230 VAC and has an internal mains unit which provides a voltage of 24 VDC/100 mA for the sensor. Free screwing clamps are available for forwarding the (0) 4...20 mA signal to superordinate controls.



Special features:

- Integrated in a well-designed wall housing
- Suitable for all common sensors with 0 (4)...20 mA signal
- Easy operation
- 2 relay outputs (230 VAC, 3 A)

Application example:

Pressure monitoring with optional alarm unit (buzzer + continuous light)

Application example:

Temperature monitoring with alarm

DESCRIPTION	ORDER NO.:
DS 52 LED process display in the wall housing	0500 0009
Options:	
Power supply 24 VDC instead of 230 VAC	Z500 0001
Power supply 110 VAC instead of 230 VAC	Z500 0002
Alarm unit mounted to the wall housing	Z500 0003
Alarm unit for external mounting	Z500 0004
Complete sets:	
DS 52 - all-in-one set for pressure monitoring/alerting, consisting of DS 52 LED display and pressure sensor 0...16 bar	on request
DS 52 - all-in-one set for temperature monitoring/alerting, consisting of DS 52 LED display and screw-in temperature sensor -50...+500 °C	on request

TECHNICAL DATA DS 52	
Dimensions:	118 x 133 x 92 mm (WxHxD)
Display:	LED, 5-digit, height 13 mm, 2 LEDs for alarm
Keypad:	4 keys: Enter, Back, Up, Down
Sensor input:	For sensors with 0 (4)...20 mA signal. Can be connected in 2-/3-/4-wire technology
Accuracy:	Max. +/- 20 µA, typically +/- 10 µA
Burden:	100 Ω
Sensor supply:	24 VDC, max. 100 mA
Power supply: (option):	230 VAC, 50/60 Hz (24 VDC or 110 VAC)
Outputs:	2 x relay output, changeover contact, 250 VAC, max. 3 A
Alarm thresholds:	Freely adjustable via keypad
Hysteresis:	Freely adjustable via keypad
Operating temperature:	-10...+60 °C (Storage temp.: -20...+80 °C)
Control menu:	Can be locked via code for unauthorised access



Headquarters Germany



Sales / technology

SALES OFFICE SOUTH CS INSTRUMENTS GmbH & Co. KG

Zindelsteiner Straße 15
78052 VS-Tannheim
Germany

Tel.: +49 (0)7705 978 99-0
Fax: +49 (0)7705 978 99-20

E-mail: info@cs-instruments.com
Web.: www.cs-instruments.com

Order processing and recalibration

SALES OFFICE NORTH CS INSTRUMENTS GmbH & Co. KG

Gewerbehof 14
24955 Harrislee
Germany

Tel.: +49 (0)461 807 150-0
Fax: +49 (0)461 807 150-15

E-mail: info@cs-instruments.com
Web.: www.cs-instruments.com

Subsidiaries of CS INSTRUMENTS



**CHINA
CS INSTRUMENTS (Shanghai) Co.,Ltd**
Room 508, JT1166, No. 1080, Moyu South Road
Anting Town, Jiading District
200003, Shanghai, China

P.: +86 13601694498
E-Mail: k.wu@cs-instruments.cn
Web.: www.cs-instruments.com/zh



**FRANCE
CS INSTRUMENTS**
4, rue du docteur Heulin
75017 Paris
France

Phone: +33 1 86 95 87 60
E-mail: info@cs-instruments.fr
Web.: www.cs-instruments.com/fr



**ITALY
CS INSTRUMENTS Italia S.r.l.**
Via Matteotti 66
20092 - Cinisello Balsamo (Mi)
Italy

Phone: +39 0225061761
E-mail: info@cs-instruments.it
Web.: www.cs-instruments.com/it



**NETHERLANDS / BELGIUM
CS INSTRUMENTS BENELUX B.V.**
Volhardingstraat 27
2020 Antwerpen
Belgium

Phone: +32 484 57 59 50
E-mail: info@cs-instruments.nl
Web.: www.cs-instruments.com/nl



**AUSTRIA
CS INSTRUMENTS GmbH**
Grazer Straße 8
8605 Kapfenberg
Austria

Phone: +43 (0)664 181 3284
E-mail: a.sieberer@cs-instruments.at
Web.: www.cs-instruments.com/at



**SWEDEN / NORWAY
CS INSTRUMENTS Skandinavia AB**
Hovlanda 30
471 93 Kållekärr
Sweden

P.: +46304668450
E-Mail: a.ahs@cs-instruments.com
Web.: www.cs-instruments.com/se



**SWITZERLAND
CS INSTRUMENTS (Switzerland) GmbH**
Mühlegasse 8
3237 Brüttelen
Switzerland

Phone: +41 32 355 4160
E-mail: info@cs-instruments.ch
Web.: www.cs-instruments.com/ch



**SPAIN
CS INSTRUMENTS, S.L.**
Avda. Cerro Milano 4, Local 1
28051 Madrid
Spain

Phone: +34 91 33 15 758
E-mail: info@cs-instruments.es
Web.: www.cs-instruments.com/es



**SOUTH AFRICA
CS INSTRUMENTS (Pty) Ltd.**
142 Briza Road, Table View
7441 Cape Town
South Africa

Phone: +27 (0)21 557 56 18
E-Mail: info@cs-instruments.co.za
Web.: www.cs-instruments.com/za



**TURKEY
CS INSTRUMENTS Ölçüm Ekipmanları Tic. Ltd. Şti.**
Yeşilbağlar Mah. D-100 Bulv.
Pendik Pera Residence A Blok No: 20K
34893 Pendik İstanbul, Turkey

Phone: +90 216 999 31 81
E-mail: info@cs-instruments.com.tr
Web.: www.cs-instruments.com/tr



**USA
CS INSTRUMENTS USA INC.**
110 Traders Cross
Bluffton, SC 29909
USA

P.: +1 239 326 3030
E-Mail: info-us@cs-instruments.com
Web.: www.cs-instruments.com/us